

AV RECEIVER/AV AMPLIFIER RX-V863/HTR-6180/ DSP-AX863SE/DSP-AX863 SERVICE MANUAL

IMPORTANT NOTICE

This manual has been provided for the use of authorized YAMAHA Retailers and their service personnel. It has been assumed that basic service procedures inherent to the industry, and more specifically YAMAHA Products, are already known and understood by the users, and have therefore not been restated.

WARNING: Failure to follow appropriate service and safety procedures when servicing this product may result in personal injury, destruction of expensive components, and failure of the product to perform as specified. For these reasons, we advise all YAMAHA product owners that any service required should be performed by an authorized YAMAHA Retailer or the appointed service representative.

IMPORTANT: The presentation or sale of this manual to any individual or firm does not constitute authorization, certification or recognition of any applicable technical capabilities, or establish a principle-agent relationship of any form.

The data provided is believed to be accurate and applicable to the unit(s) indicated on the cover. The research, engineering, and service departments of YAMAHA are continually striving to improve YAMAHA products. Modifications are, therefore, inevitable and specifications are subject to change without notice or obligation to retrofit. Should any discrepancy appear to exist, please contact the distributor's Service Division.

WARNING: Static discharges can destroy expensive components. Discharge any static electricity your body may have accumulated by grounding yourself to the ground buss in the unit (heavy gauge black wires connect to this buss).

IMPORTANT: Turn the unit OFF during disassembly and part replacement. Recheck all work before you apply power to the unit.

CONTENTS

TO SERVICE PERSONNEL	2	DISPLAY DATA	65
FRONT PANELS	3-5	IC DATA	66-82
REAR PANELS	6-10	PIN CONNECTION DIAGRAMS	83-86
REMOTE CONTROL PANELS	11	BLOCK DIAGRAMS	87-91
SPECIFICATIONS / 参考仕様	12-15	PRINTED CIRCUIT BOARDS	92-105
INTERNAL VIEW	16	SCHEMATIC DIAGRAMS	107-117
DISASSEMBLY PROCEDURES / 分解手順	16-21	REPLACEMENT PARTS LIST	119-147
UPDATING FIRMWARE / ファームウェアの書き込み	22-36	REMOTE CONTROL	148-151
SELF DIAGNOSIS FUNCTION (DIAG) / 自己診断機能 (ダイアグ)	37-63	ADVANCED SETUP / 本機の設定を変更する Using Bluetooth components / Bluetooth機器を再生する	152-154 155
CONFIRMATION OF IDLING CURRENT OF AMP UNIT / アンプユニットのアイドリング電流の確認	64		



このサービスマニュアルは、エコマーク認定の再生紙を使用しています。
This Service Manual uses recycled paper.

101088

© 2008 YAMAHA CORPORATION All rights reserved
This manual is copyrighted by YAMAHA and may not be copied or
redistributed either in print or electronically without permission.



YAMAHA

YAMAHA CORPORATION
P.O.Box 1, Hamamatsu, Japan

08.03

RX-V863/HTR-6180/
DSP-AX863SE/DSP-AX863

■ TO SERVICE PERSONNEL

1. Critical Components Information
Components having special characteristics are marked  and must be replaced with parts having specifications equal to those originally installed.
 2. Leakage Current Measurement (For 120V Models Only)
When service has been completed, it is imperative to verify that all exposed conductive surfaces are properly insulated from supply circuits.
- Meter impedance should be equivalent to 1500 ohms shunted by 0.15μF.

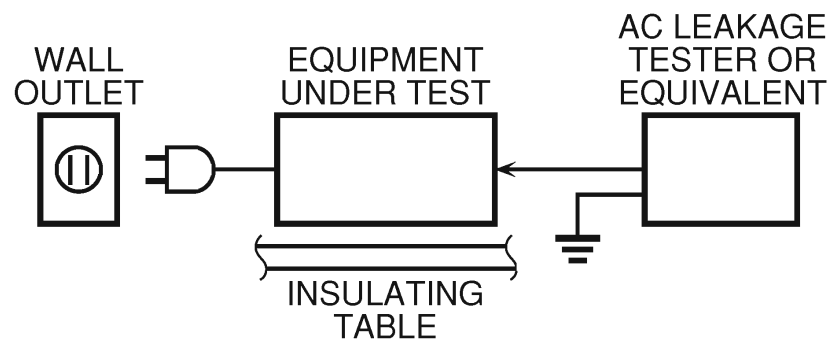

- Leakage current must not exceed 0.5mA.
- Be sure to test for leakage with the AC plug in both polarities.



For U model
“CAUTION”

“F2501, F2502: FOR CONTINUED PROTECTION AGAINST RISK OF FIRE, REPLACE ONLY WITH SAME TYPE 10A, 125V FUSE.”

For C model
CAUTION

F2501, F2502: REPLACE WITH SAME TYPE 10A, 125V FUSE.

ATTENTION

F2501, F2502: UTILISER UN FUSIBLE DE RECHANGE DE MÊME TYPE DE 10A, 125V.

WARNING: CHEMICAL CONTENT NOTICE!

This product contains chemicals known to the State of California to cause cancer, or birth defects or other reproductive harm.

DO NOT PLACE SOLDER, ELECTRICAL/ELECTRONIC OR PLASTIC COMPONENTS IN YOUR MOUTH FOR ANY REASON WHAT SO EVER!

Avoid prolonged, unprotected contact between solder and your skin! When soldering, do not inhale solder fumes or expose eyes to solder/flux vapor!

If you come in contact with solder or components located inside the enclosure of this product, wash your hands before handling food.

About lead free solder / 無鉛ハンダについて

All of the P.C.B.s installed in this unit and solder joints are soldered using the lead free solder.

Among some types of lead free solder currently available, it is recommended to use one of the following types for the repair work.

- Sn + Ag + Cu (tin + silver + copper)
- Sn + Cu (tin + copper)
- Sn + Zn + Bi (tin + zinc + bismuth)

Caution:

As the melting point temperature of the lead free solder is about 30°C to 40°C (50°F to 70°F) higher than that of the lead solder, be sure to use a soldering iron suitable to each solder.

本機に搭載されているすべての基板およびハンダ付けによる接合部は無鉛ハンダでハンダ付けされています。

無鉛ハンダにはいくつかの種類がありますが、修理時には下記のような無鉛ハンダの使用を推奨します。

- Sn+Ag+Cu(錫+銀+銅)
- Sn+Cu(錫+銅)
- Sn+Zn+Bi(錫+亜鉛+ビスマス)

注意：

無鉛ハンダの融点温度は通常の鉛入りハンダに比べ30～40℃程度高くなっていますので、それぞれのハンダに合ったハンダごてをご使用ください。

RX-V863/HTR-6180/DSP-AX863SE/DSP-AX863

FRONT PANELS

RX-V863 (U model)

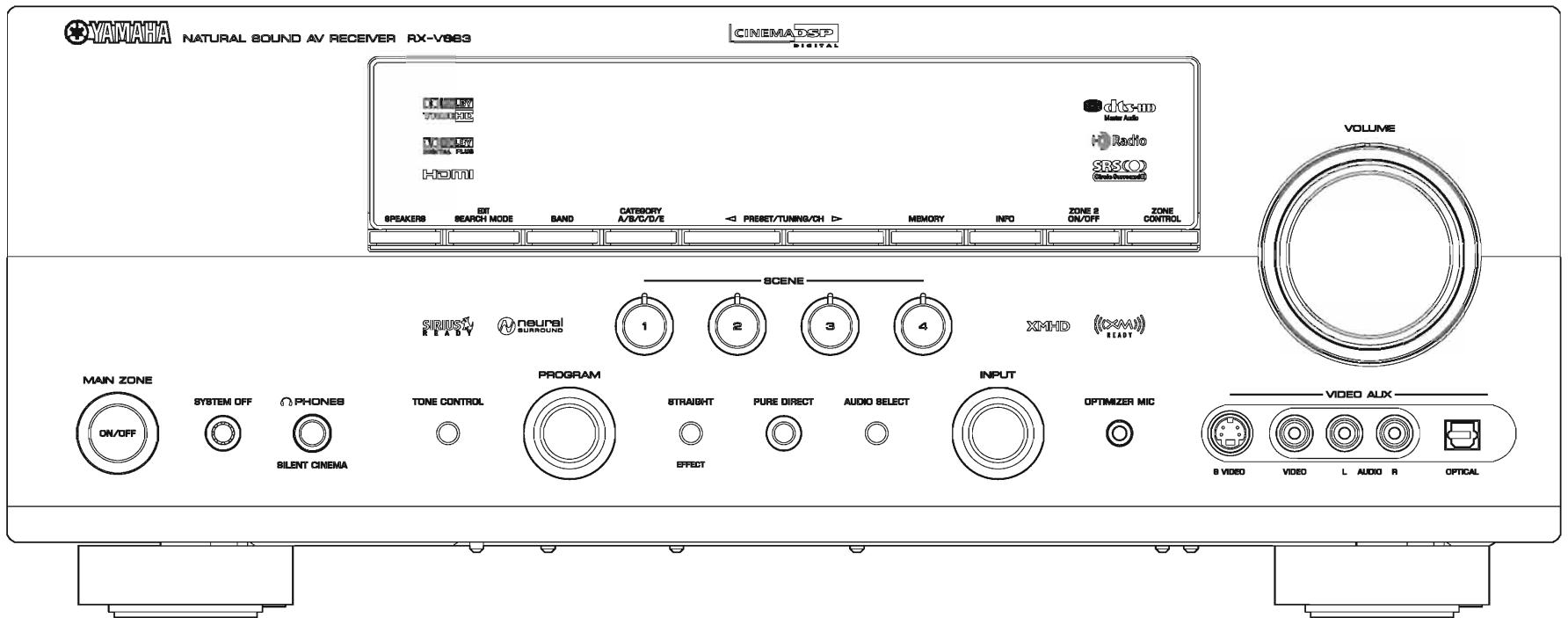

RX-V863 (C model)

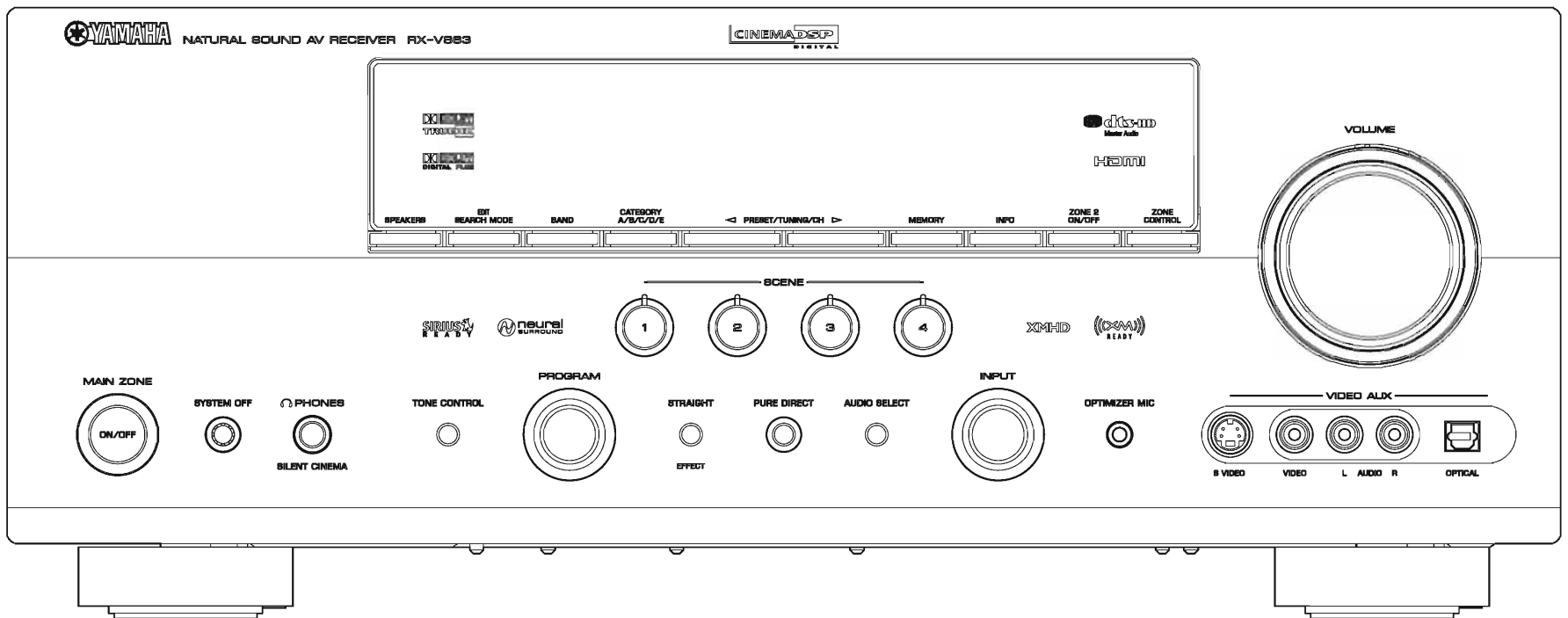

RX-V863 (R, T, K, A, G, E, F, L models)

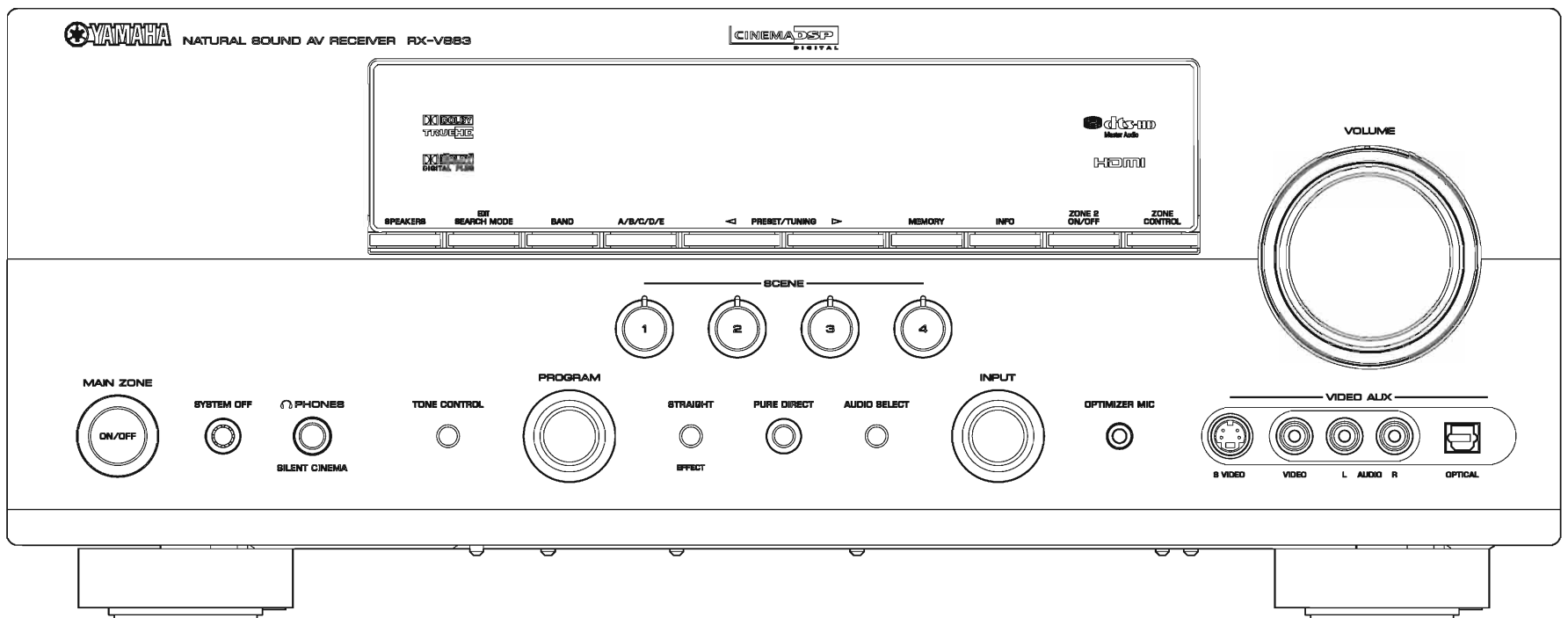

RX-V863/HTR-6180/
DSP-AX863SE/DSP-AX863

HTR-6180 (U model)

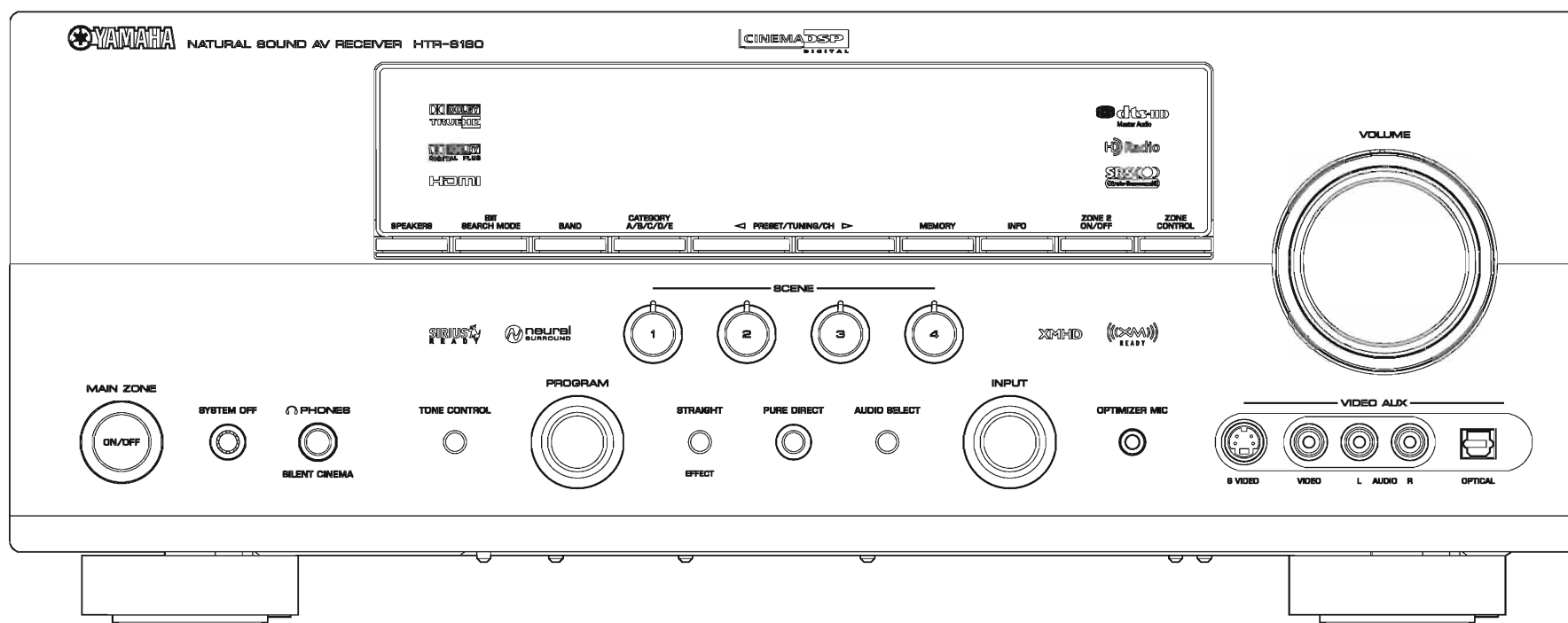

HTR-6180 (C model)

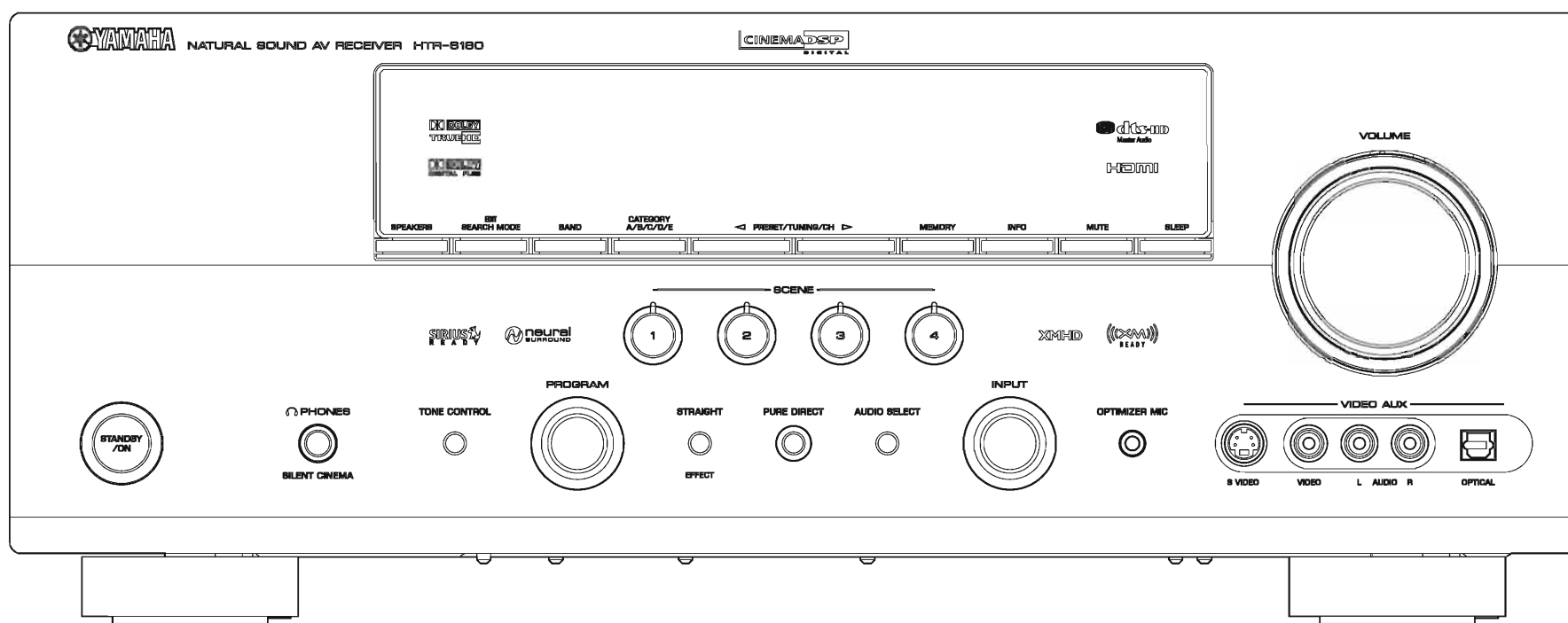

HTR-6180 (F model)

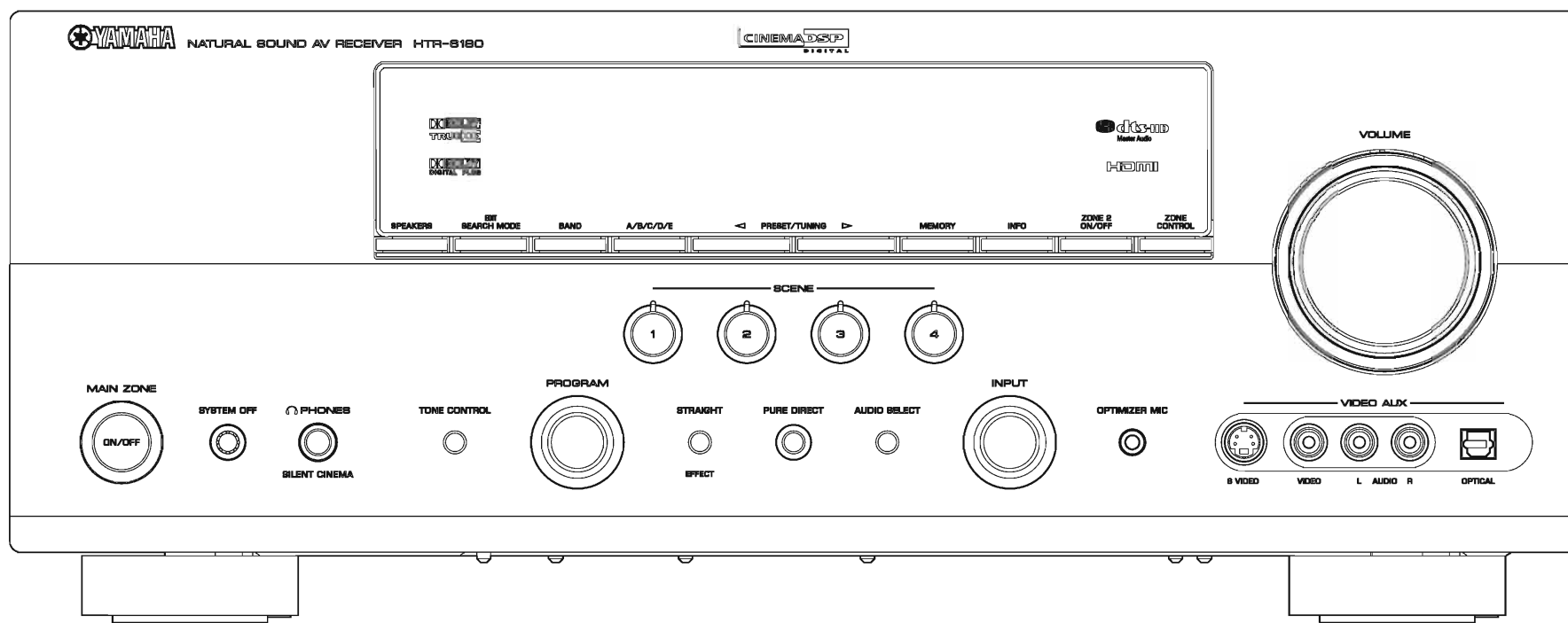

RX-V863/HTR-6180/
DSP-AX863SE/DSP-AX863

DSP-AX863SE (B model)

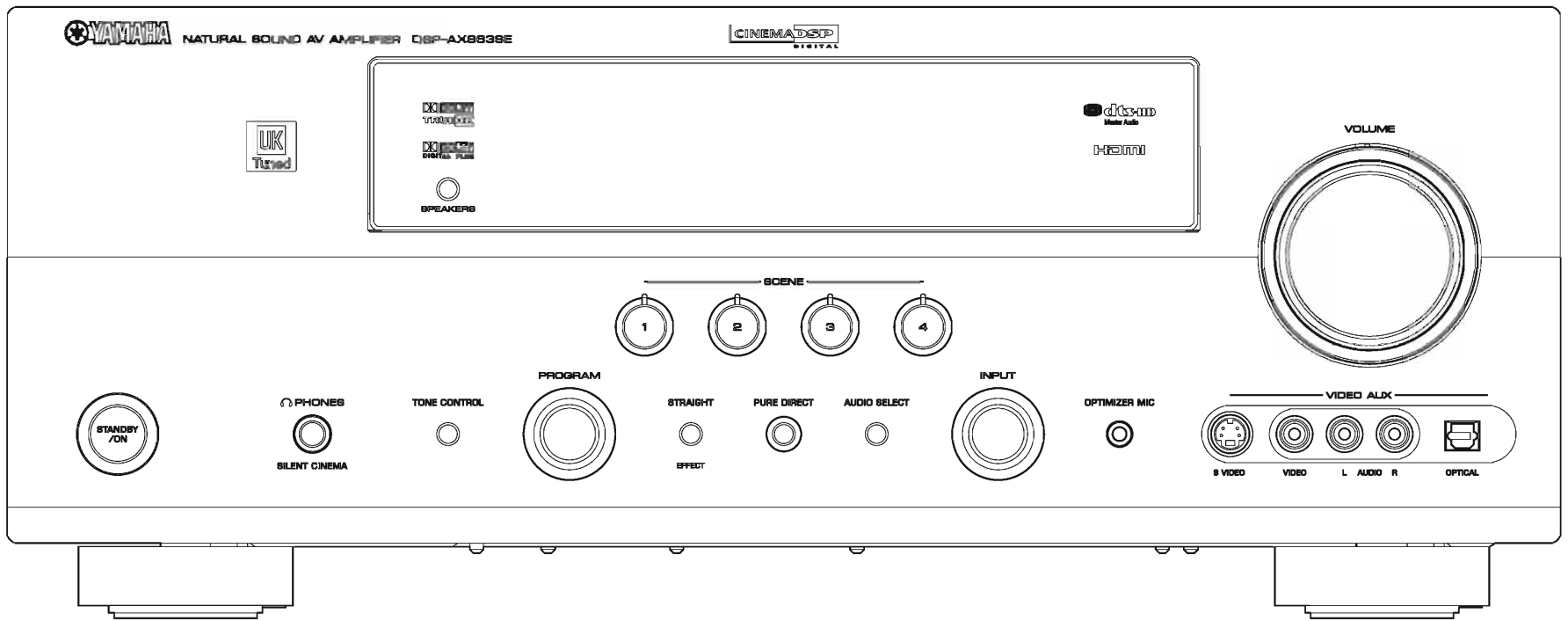

DSP-AX863 (J model)

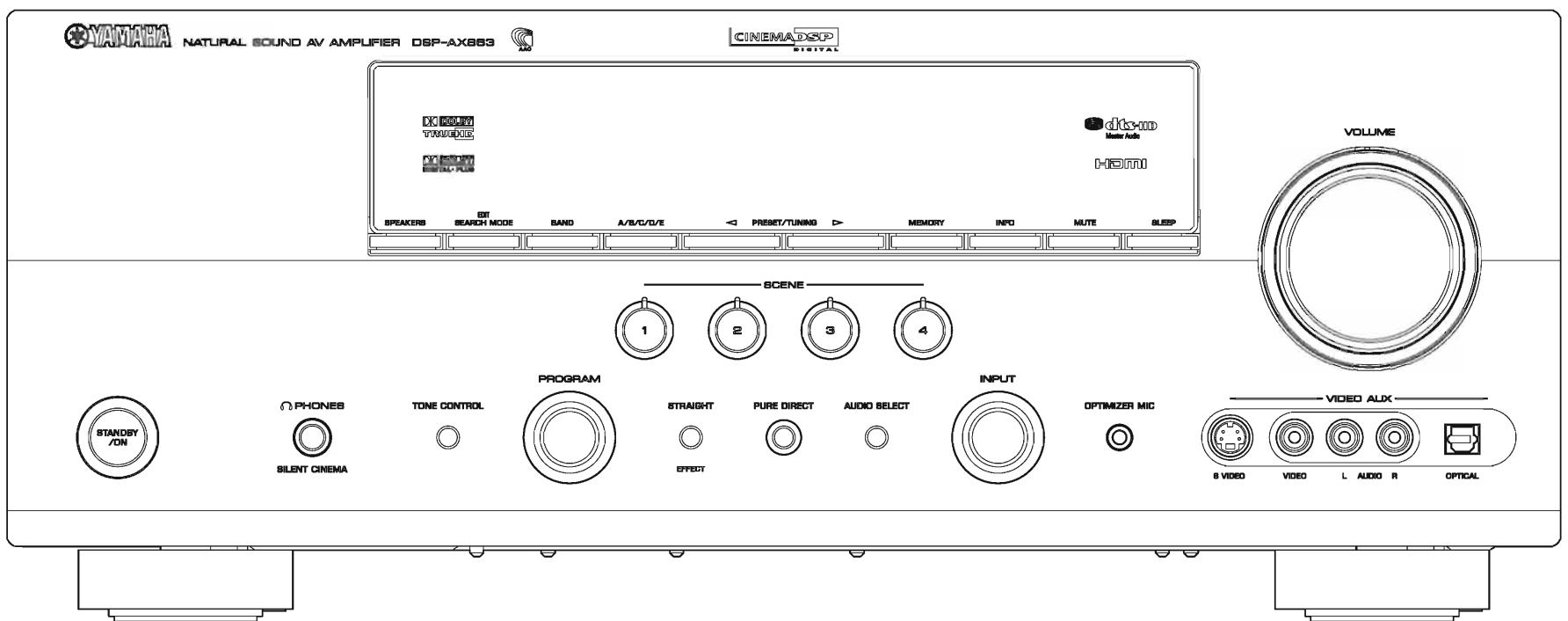

REAR PANELS

RX-V863 (U model)

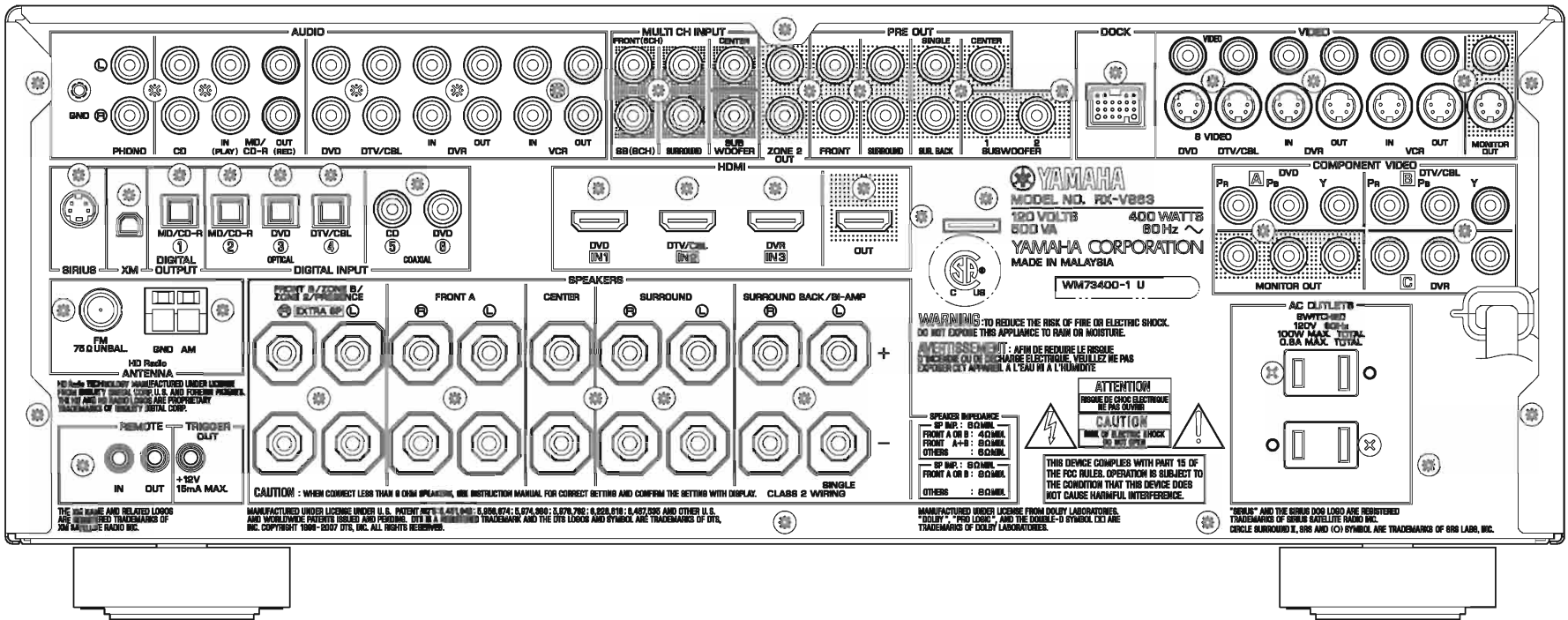

RX-V863 (C model)

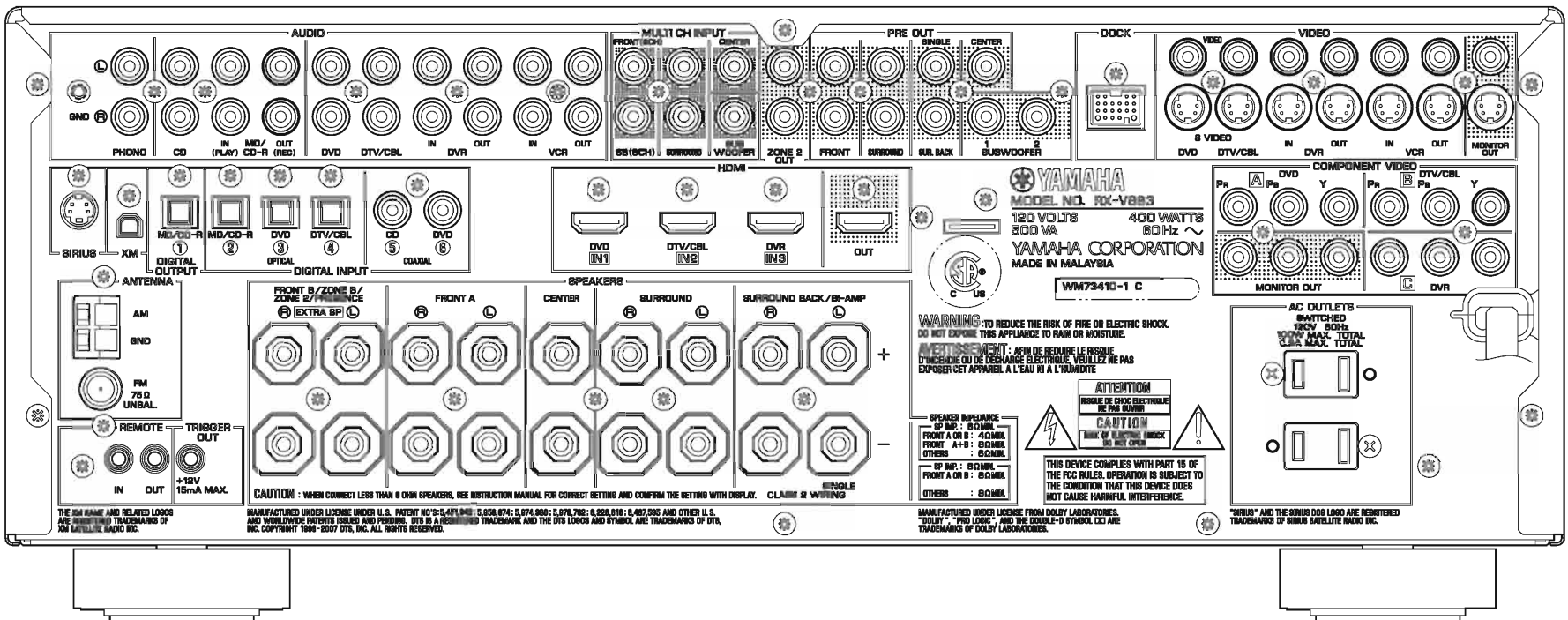

RX-V863 (R model)

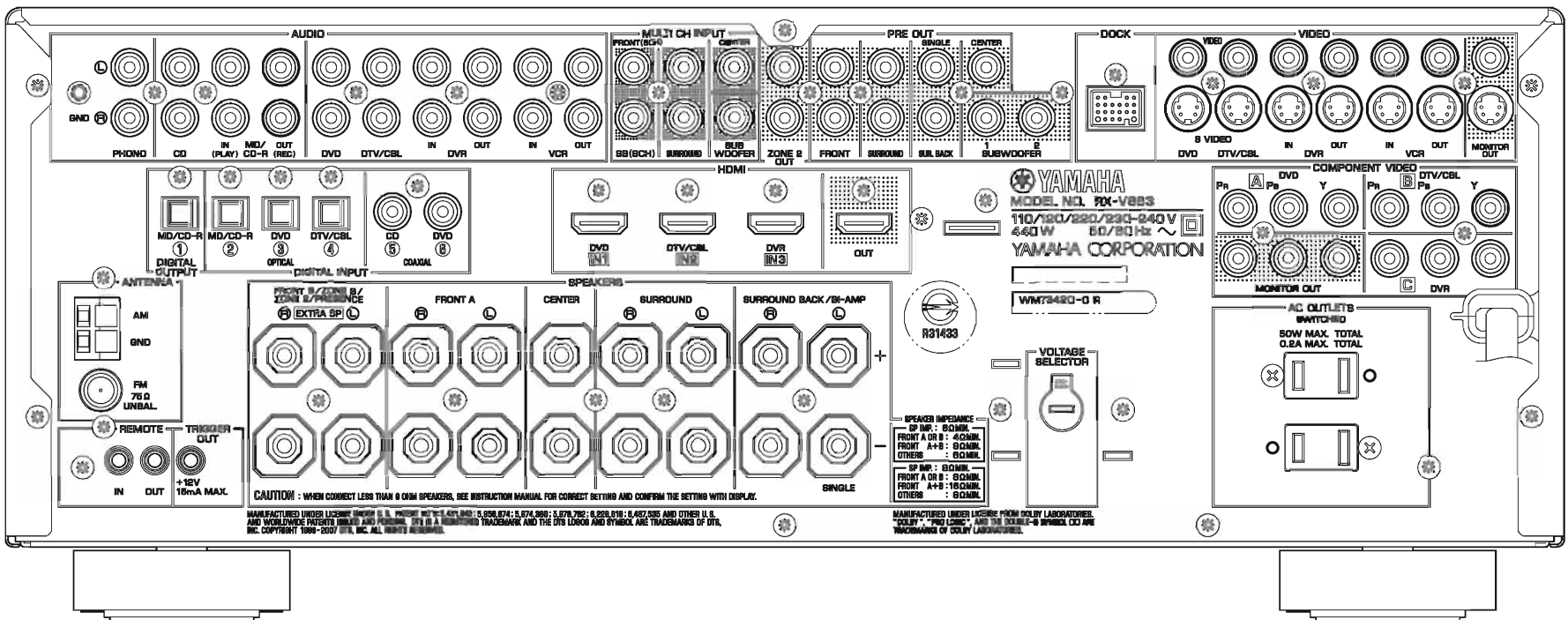

RX-V863/HTR-6180/DSP-AX863SE/DSP-AX863

RX-V863 (T model)

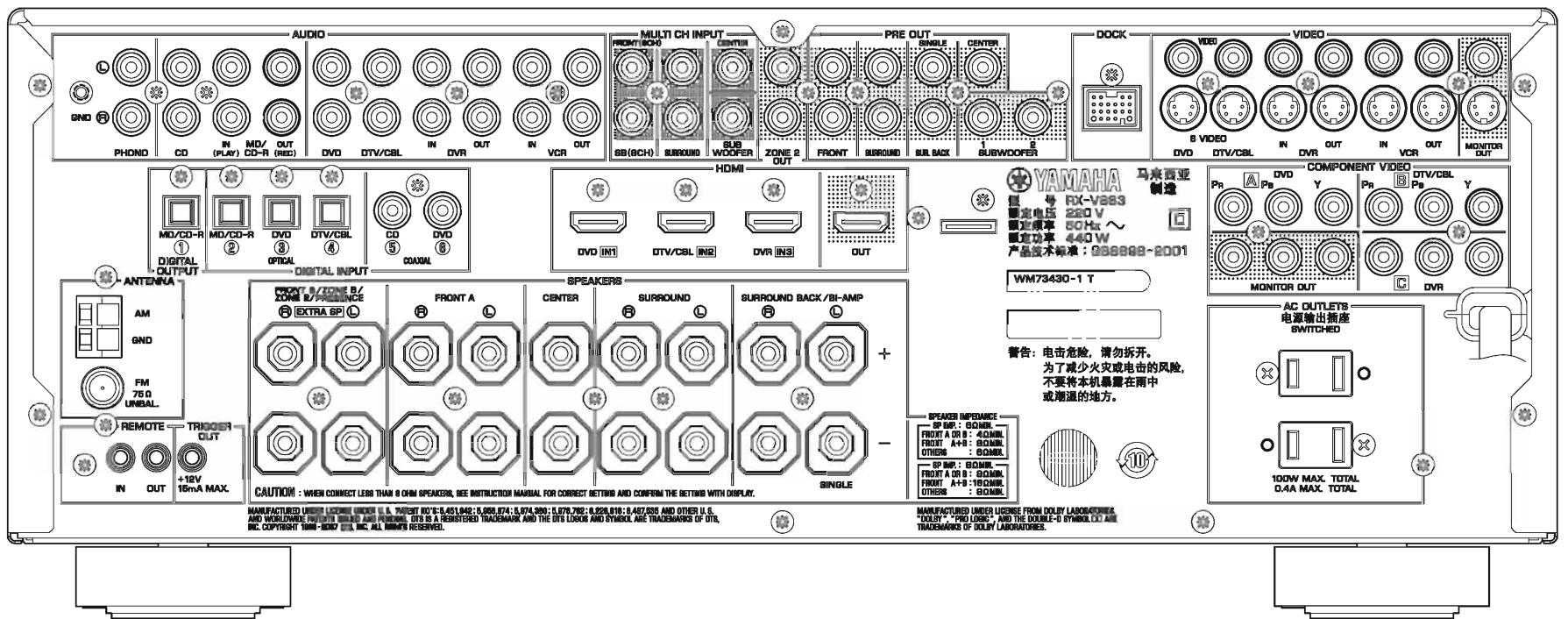

RX-V863 (K model)

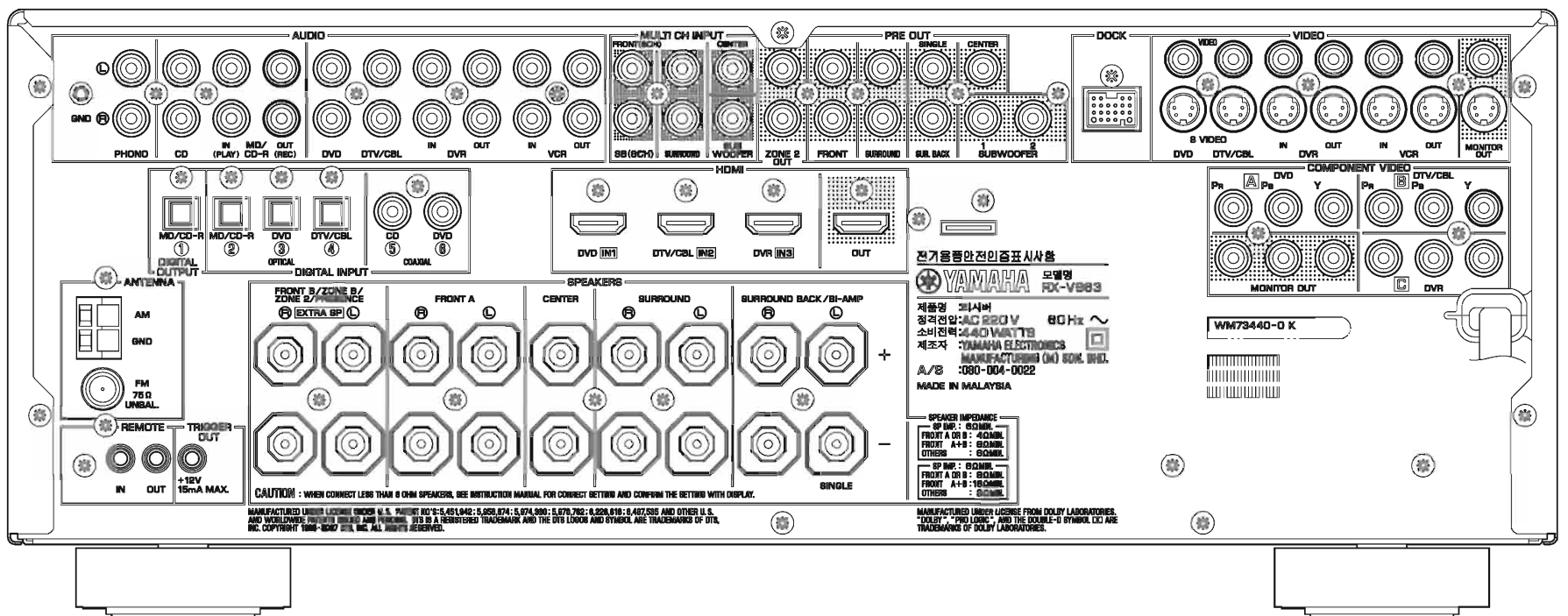

RX-V863 (A model)

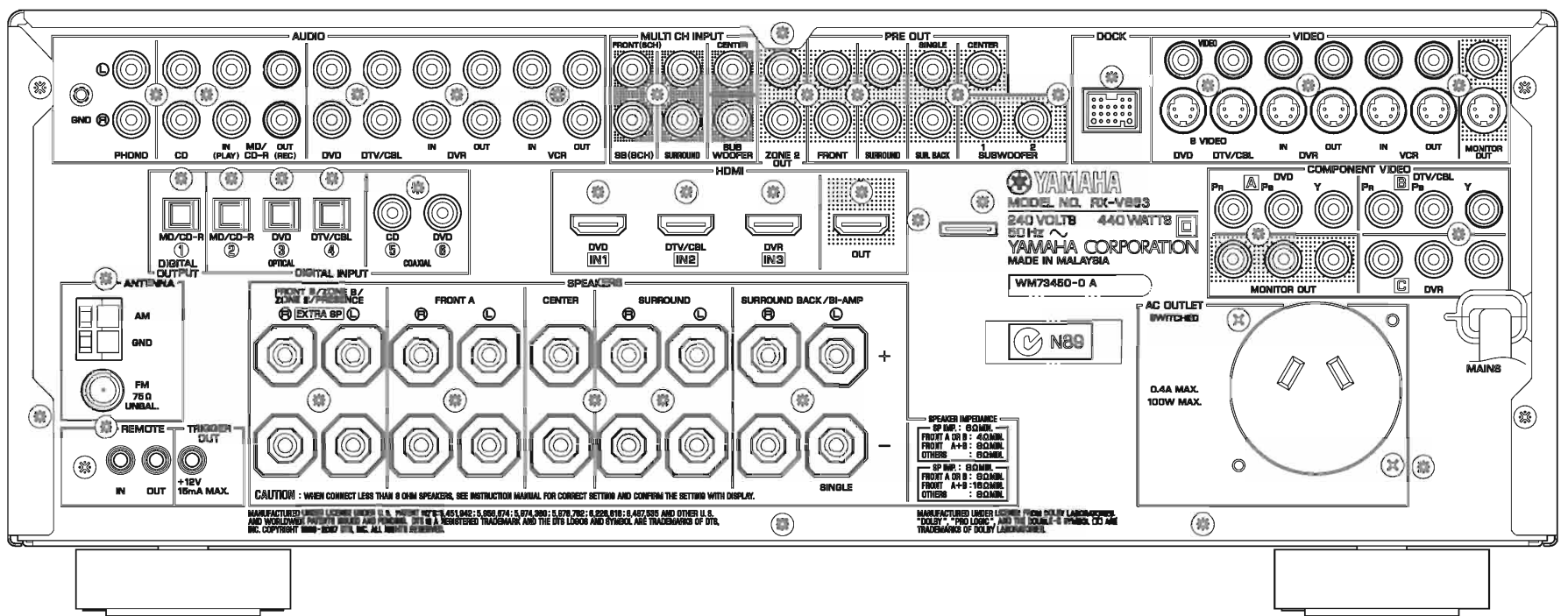

RX-V863/HTR-6180/
 DSP-AX863SE/DSP-AX863

RX-V863/HTR-6180/DSP-AX863SE/DSP-AX863

RX-V863 (G, E, F models)

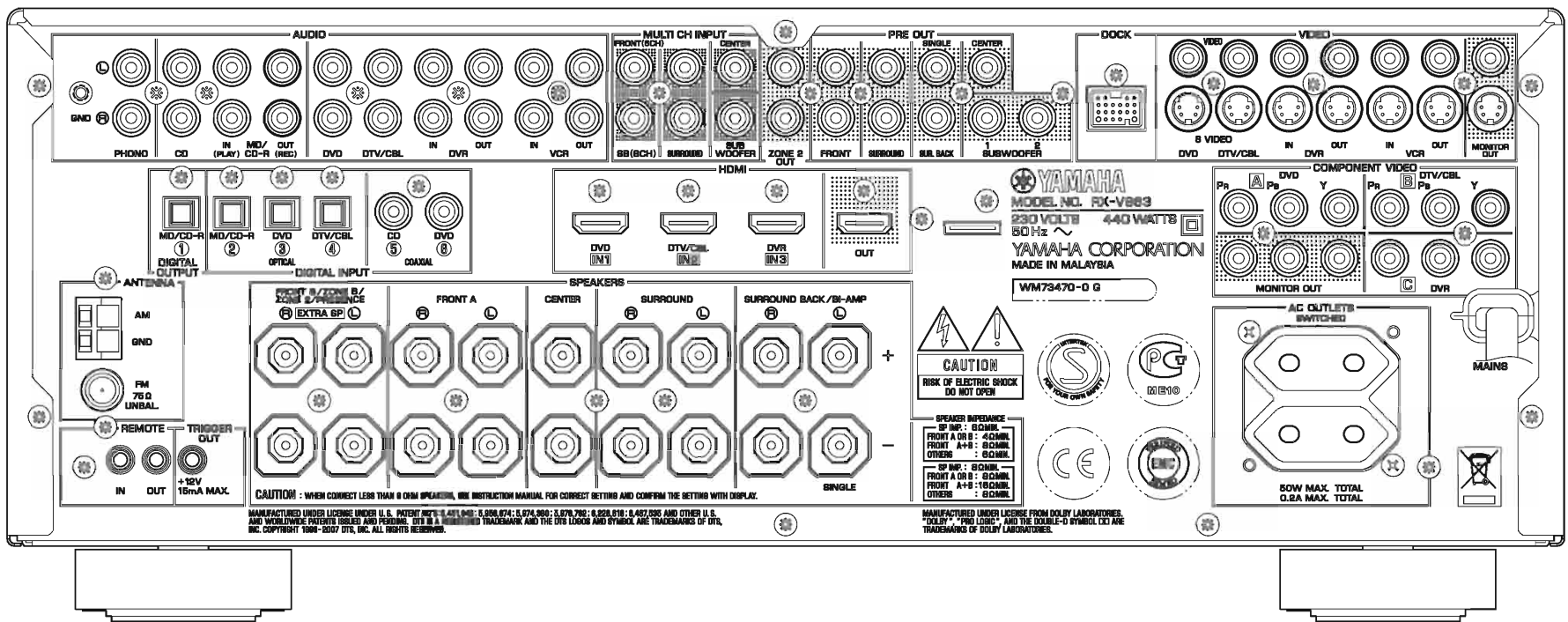

RX-V863 (L model)

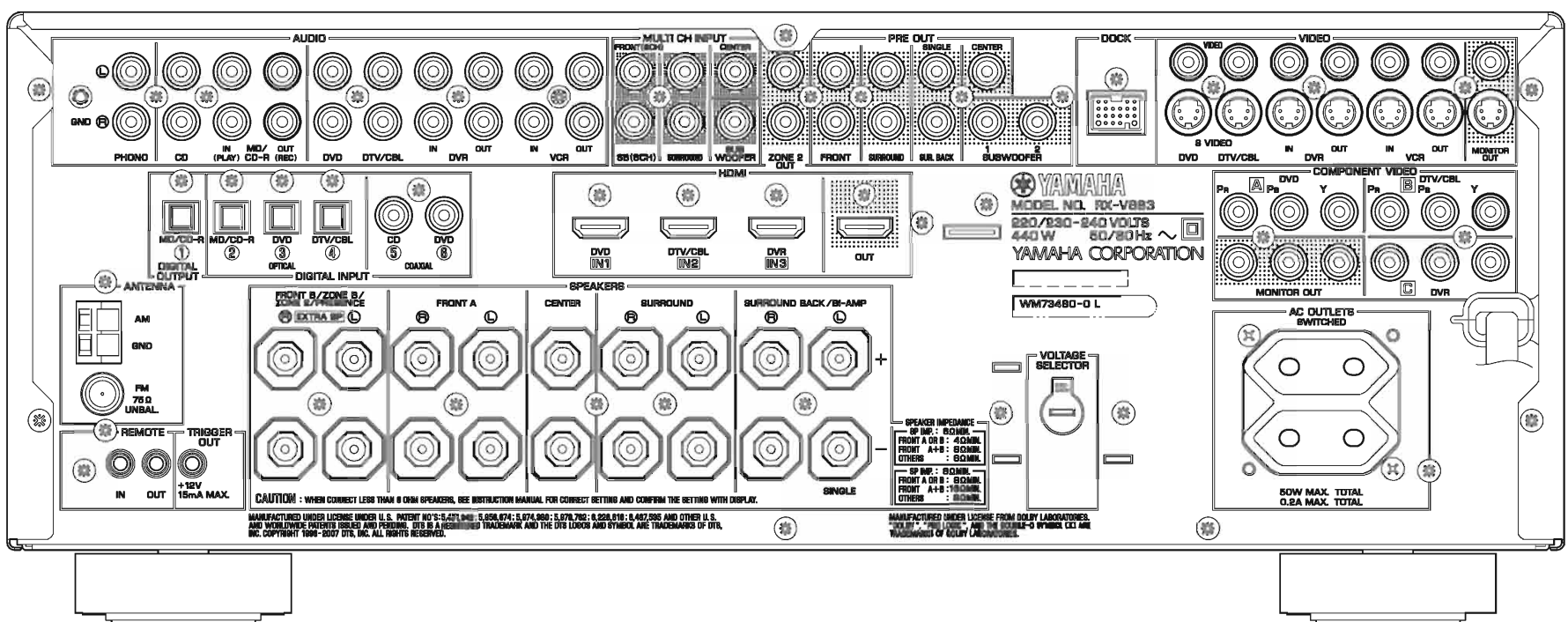

HTR-6180 (U model)

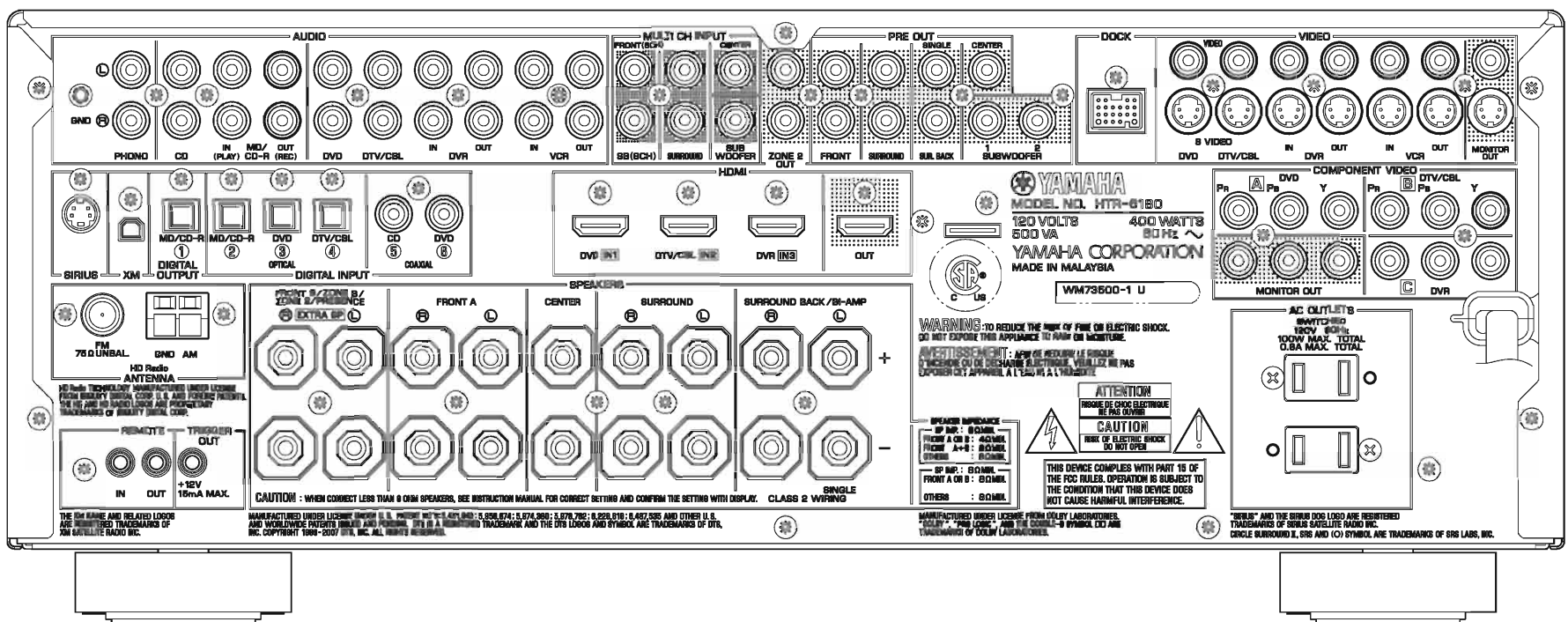

RX-V863/HTR-6180/DSP-AX863SE/DSP-AX863

HTR-6180 (C model)

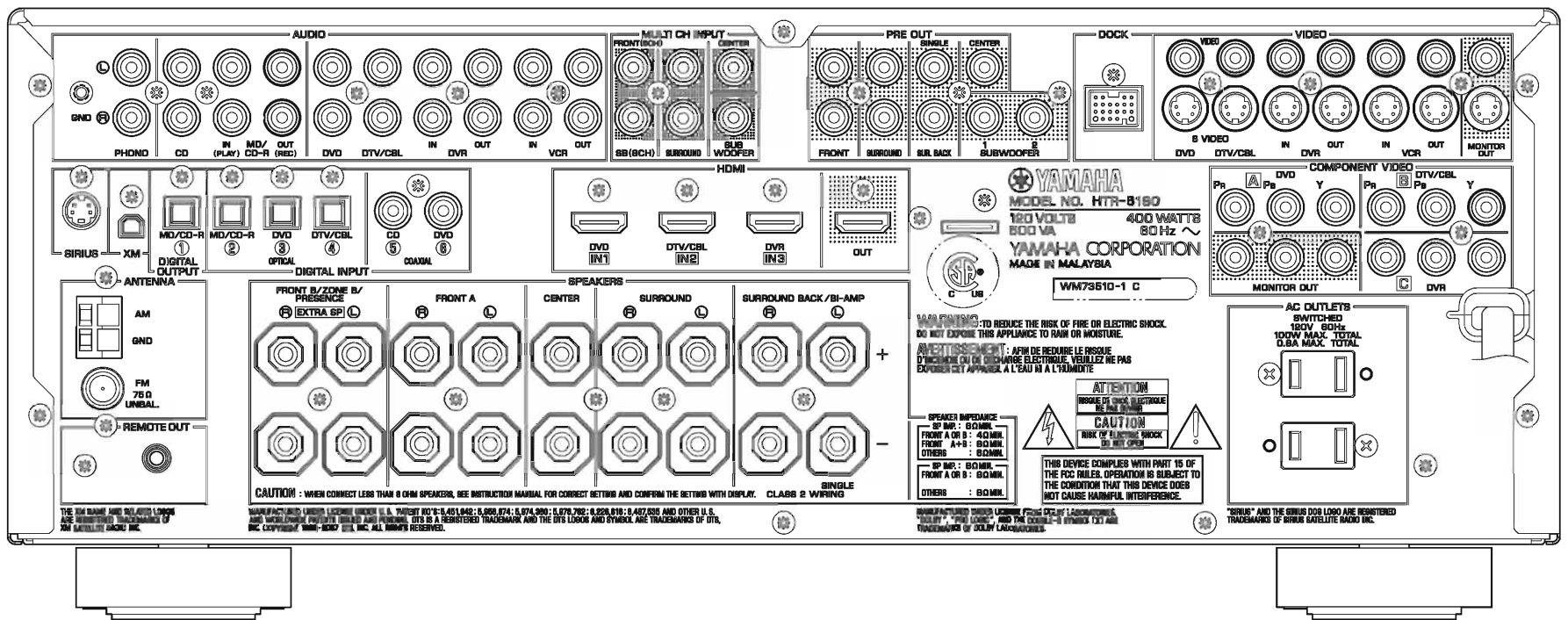

HTR-6180 (F model)

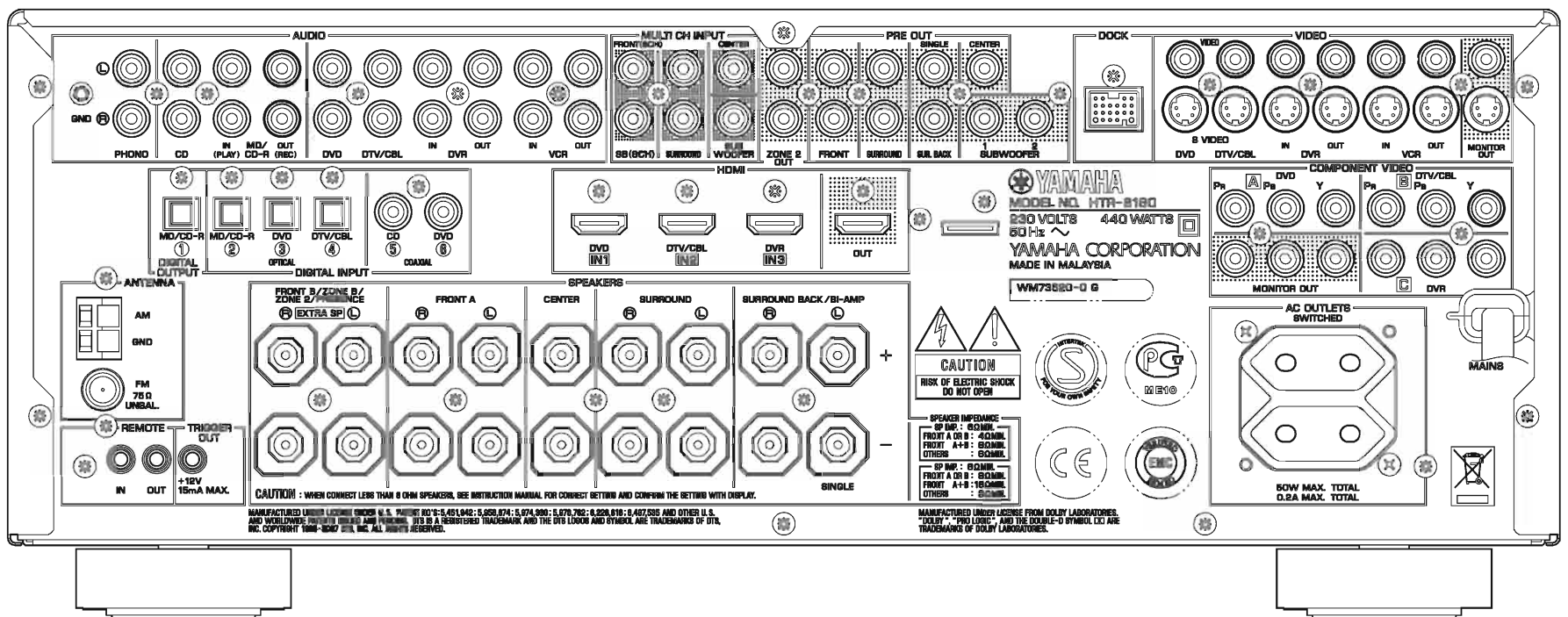

DSP-AX863SE (B model)

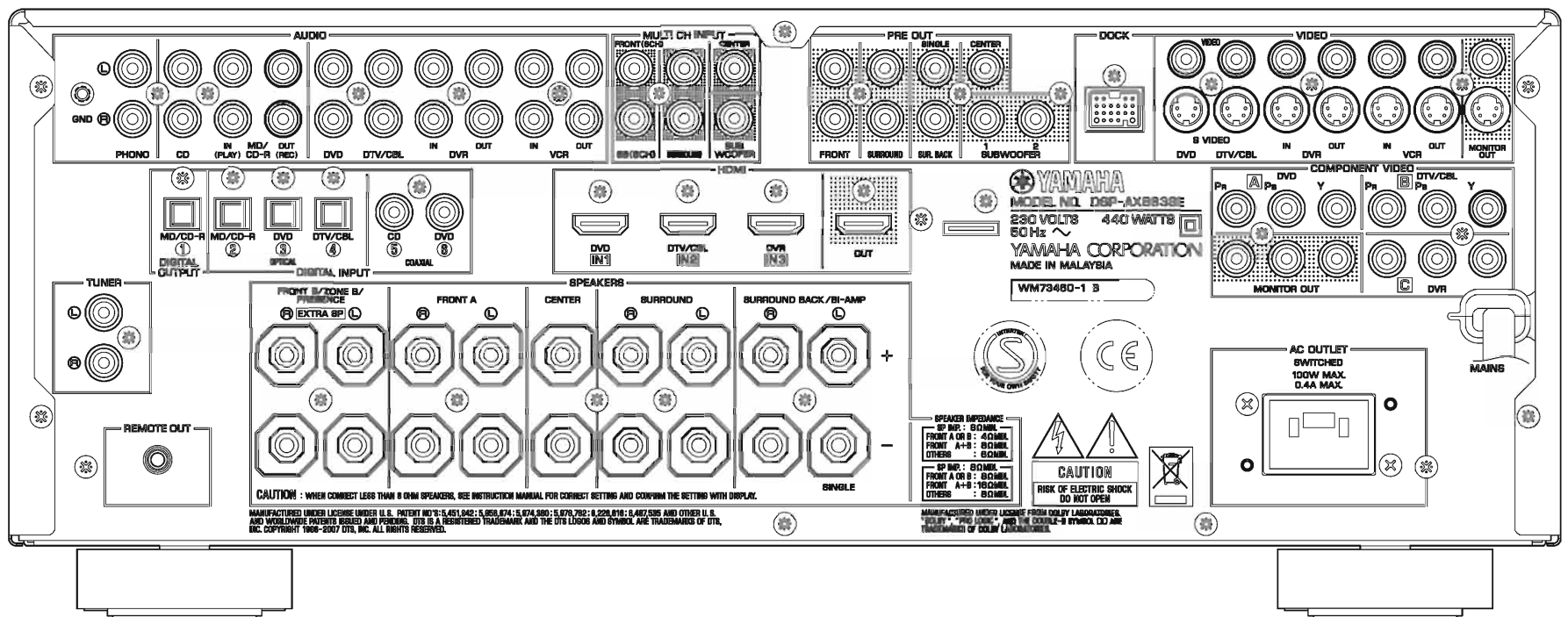

RX-V863/HTR-6180/
 DSP-AX863SE/DSP-AX863

DSP-AX863 (J model)

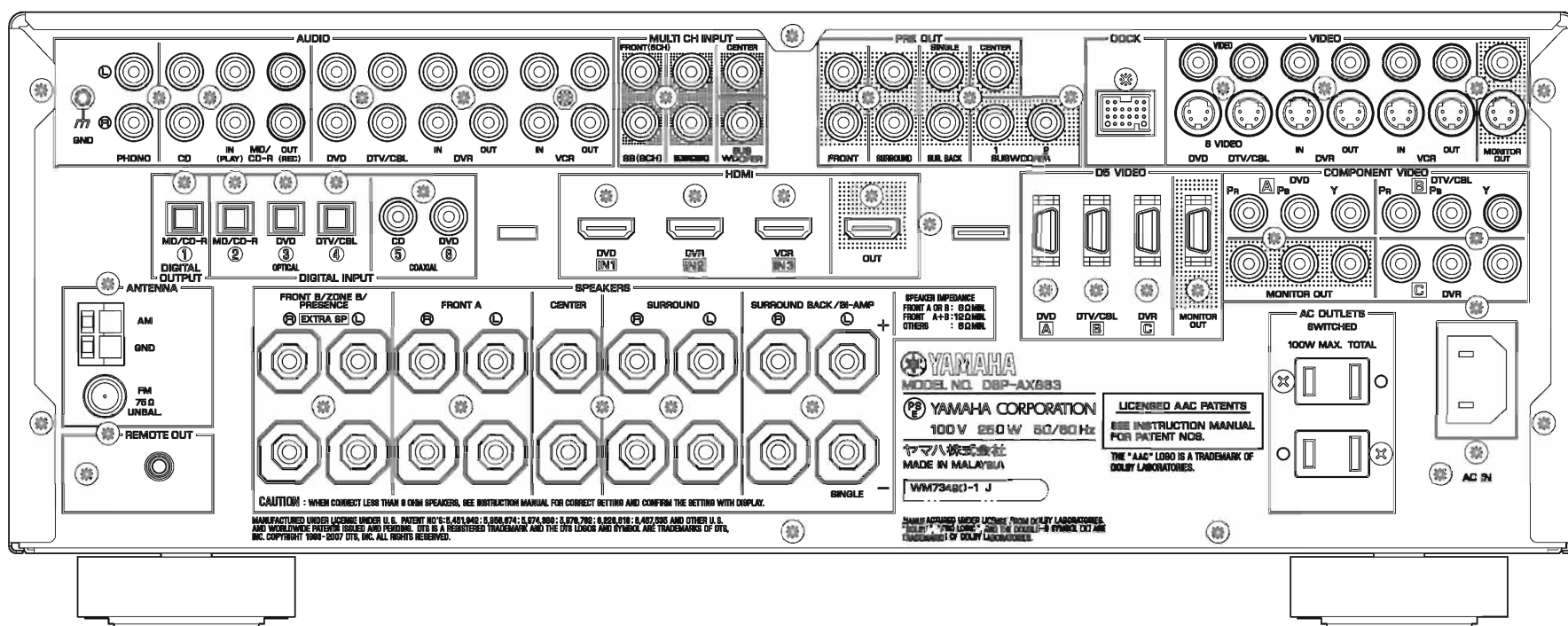

■ REMOTE CONTROL PANELS

- RAV329
RX-V863 (U, C models)
HTR-6180 (U, C models)

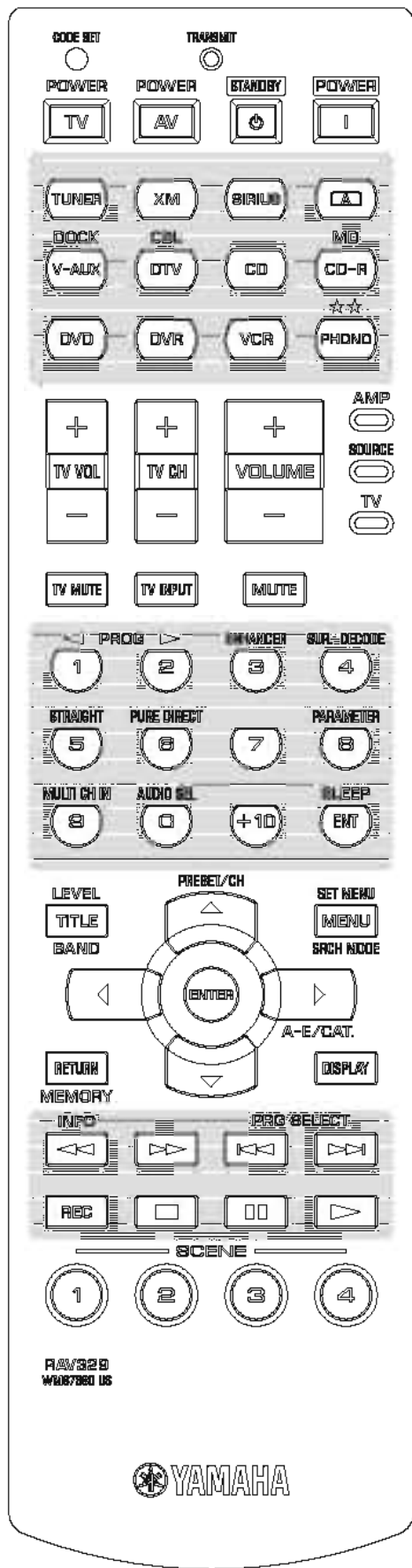

- RAV330
RX-V863 (R, T, A, L models)
DSP-AX863 (J model)

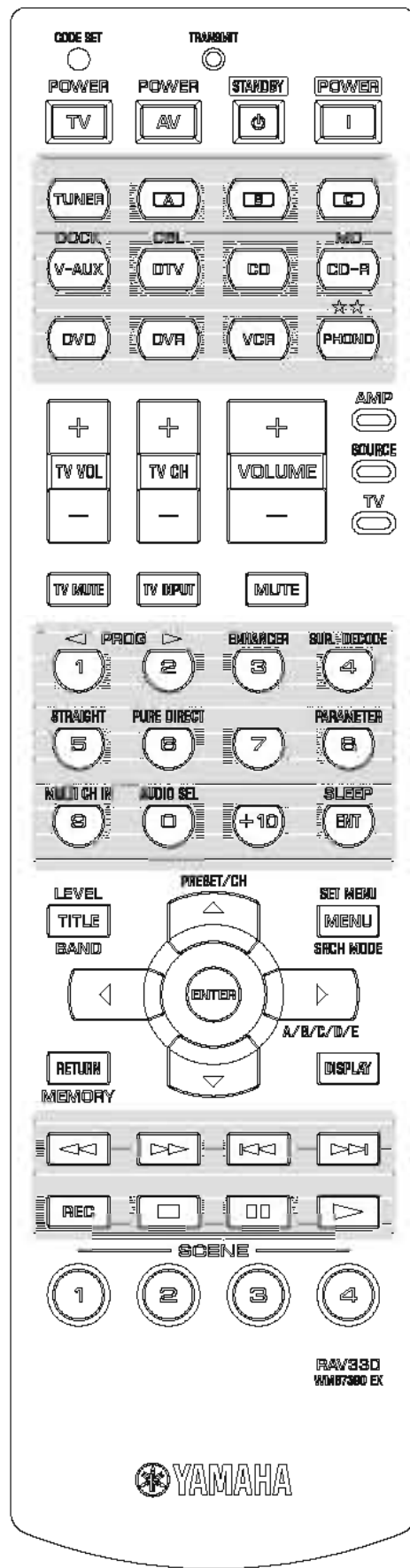

- RAV372
RX-V863 (K, G, E, F models)
HTR-6180 (F model)
DSP-AX863SE (B model)

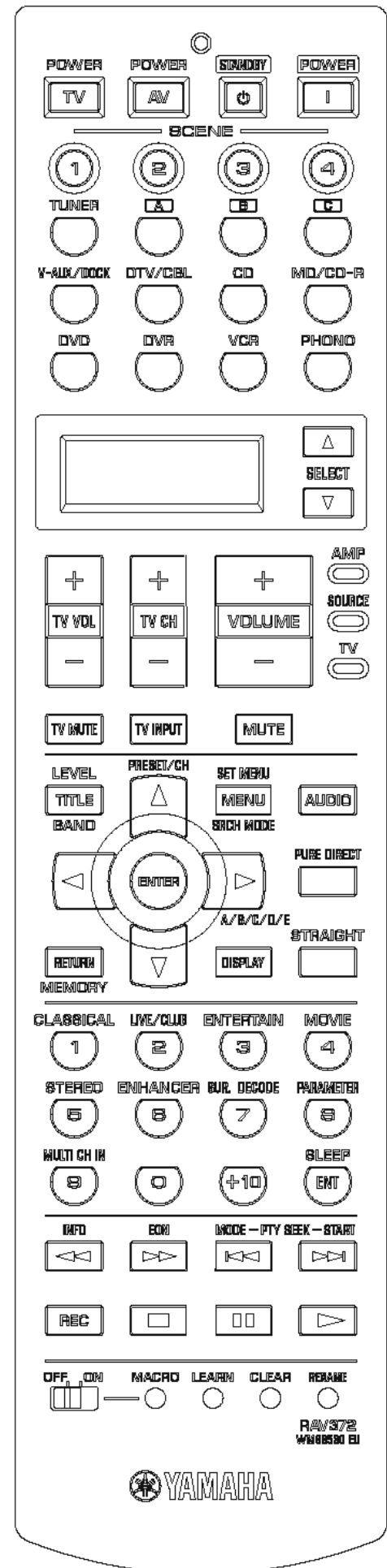

SPECIFICATIONS / 参考仕様

Audio Section / オーディオ部

Minimum RMS Output Power (Power Amp. Section) / 定格出力 (パワーアンプ部)
[RX-V863/DSP-AX863/DSP-AX863SE] (20 Hz to 20 kHz)
 U, C, R, T, K, A, B, G, E, F, L models (0.06 % THD, 8 ohms)
 J model (0.09 % THD, 6 ohms)

FRONT L/R	105 W + 105 W
CENTER	105 W
SURROUND L/R	105 W + 105 W
SURROUND BACK L/R	105 W + 105 W

[HTR-6180] (1 kHz, 0.7 % THD, 8 ohms)

FRONT L/R	120 W + 120 W
CENTER	120 W
SURROUND L/R	120 W + 120 W
SURROUND BACK L/R	120 W + 120 W

Maximum Power / 実用最大出力 (JEITA, 1 kHz, 10 % THD)

FRONT L/R	
R, T, K, L models (8 ohms)	145 W + 145 W
J model (6 ohms)	145 W + 145 W
CENTER	
R, T, K, L models (8 ohms)	145 W
J model (6 ohms)	145 W
SURROUND L/R	
R, T, K, L models (8 ohms)	145 W + 145 W
J model (6 ohms)	145 W + 145 W
SURROUND BACK L/R	
R, T, K, L models (8 ohms)	145 W + 145 W
J model (6 ohms)	145 W + 145 W

Max. Power Per Channel
 (SP impedance set: 8 ohms minimum, 1 kHz, 0.7 % THD, 4 ohms)

B, G, E, F, L models	
FRONT L/R	155 W + 155 W
CENTER	155 W
SURROUND L/R	155 W + 155 W
SURROUND BACK L/R	155 W + 155 W

IEC Power (1 kHz, 0.06 % THD, 8 ohms)

B, G, E, F, L models	
FRONT L/R	115 W + 115 W

Dynamic Power Per Channel / ダイナミックパワー (IHF)

FRONT L/R (8/6/4/2 ohms)	
U, C, R, T, K, A, B, G, E, F, L models	140/175/205/250 W
J model	-/145/175/220 W

Dynamic Headroom

U, C models (8 ohms)	1.25 dB
----------------------	---------

Damping Factor / ダンピングファクタ

FRONT L/R (20 Hz to 20 kHz, SPEAKER-A, 8 ohms)	120 or more
--	-------------

Input Sensitivity/Input Impedance / 入力感度/入力インピーダンス (1 kHz, 100 W/8 ohms)

PHONO (MM)	3.5 mV / 47 k-ohms
CD, etc.	200 mV / 47 k-ohms
MULTI CH INPUT	
FRONT L/R, CENTER, SURROUND L/R, SURROUND BACK L/R, SUBWOOFER	200 mV / 47 k-ohms

Maximum Input Signal Level / 最大許容入力 (1 kHz)

PHONO (MM) (0.1 % THD)	60 mV or more
CD, etc. (Effect on) (0.5 % THD)	2.3 V or more

Output Level/Output Impedance / 出力電圧/出力インピーダンス

REC OUT	200 mV / 1.2 k-ohms
PRE OUT (FRONT L/R, CENTER, SURROUND L/R, SURROUND BACK L/R)	1.0 V / 1.2 k-ohms
SUBWOOFER (2ch stereo & FRONT L/R SP: small)	2.0 V / 1.2 k-ohms

[RX-V863 (U, C, R, T, K, A, G, E, F, L models)/HTR-6180 (U, F models)]

ZONE2 OUT	200 mV / 1.2 k-ohms
-----------	---------------------

Headphone Jack Rated Output/Impedance / ヘッドフォン出力/出力インピーダンス

CD, etc. (1 kHz, 50 mV, 8 ohms)	150 mV / 100 ohms
---------------------------------	-------------------

Frequency Response / 周波数特性 (10 Hz to 100 kHz)

CD, etc. to FRONT L/R (Pure direct)	+0/-3.0 dB
-------------------------------------	------------

RIAA Equalization Deviation / RIAA偏差 (20 Hz to 20 kHz)

PHONO (MM)	0 ± 0.5 dB
------------	------------

Total Harmonic Distortion / 全高調波歪率 (20 Hz to 20 kHz)

PHONO (MM) to REC OUT (1 V)	0.02 % or less
CD, etc. (2ch stereo) to FRONT L/R SP OUT (50 W, 8 ohms)	0.06 % or less

Signal to Noise Ratio / 信号対雑音比 (IHF-A network)

PHONO (MM) (Input shorted) to REC OUT	
U, C, R, T models (5 mV)	86 dB or more
K, A, B, G, E, F, L models (5 mV)	81 dB or more
J model (2.5 mV)	80 dB or more
CD, etc. (Effect off) (Input shorted) to SP OUT	
250 mV	100 dB or more

Residual Noise / 残留ノイズ (IHF-A network)

FRONT L/R, SP OUT	150 µV or less
-------------------	----------------

Channel Separation / チャンネルセパレーション (1 kHz/10 kHz)

PHONO (Input shorted)	60 dB or more/55 dB or more
CD, etc. (Input 5.1 k-ohms shorted)	60 dB or more/45 dB or more

Volume Control / 可変範囲/ステップ

MUTE/-80 dB to +16.5 dB/0.5 dB step	
-------------------------------------	--

Tone Control Characteristics / トーンコントロール特性

BASS

Boost/Cut	± 10 dB/2 dB (step 50 Hz)
Turnover frequency	350 Hz

TREBLE

Boost/Cut	± 10 dB/2 dB (step 20 kHz)
Turnover frequency	3.5 kHz

Filter Characteristics / フィルター特性 (fc=40/60/80/90/100/110/120/160/200 Hz)

FRONT, CENTER, SURROUND, SURROUND BACK small (H.P.F.)	12 dB/oct.
SUBWOOFER (L.P.F.)	24 dB/oct.

Video Section / ビデオ部

Video Signal Type / ビデオ信号方式

Gray back	
U, C, R, K, J models	NTSC
T, A, B, G, E, F, L models	PAL
Video conversion	NTSC/PAL

Composite Video Signal Level / コンポジットビデオ信号

	1 Vp-p / 75 ohms
--	------------------

S-Video Signal Level / Sビデオ信号

Y	1 Vp-p / 75 ohms
C	0.286 Vp-p / 75 ohms

Component Video Signal Level / コンポーネントビデオ信号

Y	1 Vp-p / 75 ohms
Cb/Cr	0.7 Vp-p / 75 ohms

D5-Video Signal Level / D5ビデオ信号 (J model)

Y	1 Vp-p / 75 ohms
Cb/Cr	0.7 Vp-p / 75 ohms

Video Maximum Input Level / ビデオ最大許容入力

VIDEO CONV. OFF	1.5 Vp-p or more
-----------------	------------------

Video Signal to Noise Ratio / ビデオ信号対雑音比

VIDEO CONV. OFF	50 dB or more
-----------------	---------------

Monitor Out Frequency Response / モニターアウト周波数帯域 (VIDEO CONV. OFF)

Component video signal level	5 Hz to 100 MHz, -3 dB
D5-video signal level (J model)	5 Hz to 100 MHz, -3 dB

HDMI Ver. 1.3a

FM Section / FM部 [U, C, R, T, K, A, G, E, F, L, J models]

Tuning Range / 受信周波数範囲

U, C models	87.5 to 107.9 MHz
R, L models	87.5 to 108.0 / 87.50 to 108.00 MHz
T, K, A, G, E, F models	87.50 to 108.00 MHz
J model	76.0 to 90.0 MHz

50dB Quieting Sensitivity / 50 dB SN感度 (IHF, 1 kHz, 100 % MOD.)

Mono	2.8 µV (20.2 dBf)
------	-------------------

Signal to Noise Ratio / 信号対雑音比 (IHF)

Mono / Stereo	73 dB / 70 dB
U model	
HD	80 dB

Harmonic Distortion / 歪率 (1 kHz)

Mono / Stereo	0.5 % / 0.5 %
U model	
HD	0.03 %

Antenna Input / アンテナ入力 75 ohms unbalanced

RX-V863/HTR-6180/DSP-AX863SE/DSP-AX863

■ AM Section / AM部 [U, C, R, T, K, A, G, E, F, L, J models]

Tuning Range / 受信周波数範囲	
U, C models	530 to 1,710 KHz
R, L models	530 to 1,710 / 531 to 1,611 KHz
T, K, A, G, E, F, J models	531 to 1,611 KHz
Antenna Input / アンテナ入力	Loop antenna

■ General / 総合

Power Supply / 電源電圧	
U, C models	AC 120 V, 60 Hz
R model	AC 110/120/230/230-240 V, 50/60 Hz
T model	AC 220 V, 50 Hz
K model	AC 220 V, 60 Hz
A model	AC 240 V, 50 Hz
B, G, E, F models	AC 230 V, 50 Hz
L model	AC 220/230-240 V, 50/60 Hz
J model	AC 100 V, 50/60 Hz
Power Consumption / 消費電力	
U, C models	400 W / 500 VA
R, T, K, A, B, G, E, F, L models	440 W
J model	300 W
Standby Power Consumption (reference data) / 待機時消費電力(参考値)	
U, C models	0.8 W
R, T, K, A, B, G, E, F, L, J models	0.1 W
Maximum Power Consumption (6ch drive, 10% THD)	
R model	850 W
AC Outlets / ACプラグアウト	
2 switched outlets	
U, C, T, J models	100 W max. total
R, G, E, F, L models	50 W max. total
1 switched outlet	
A, B models	100 W max.
Dimensions / 寸法 (W x H x D)	
Weight / 質量	435 x 171 x 393 mm (17-1/8" x 6-3/4" x 15-1/2")
Finish / 仕上げ	11.9 kg (26 lbs, 3 oz.)

[RX-V863J]	Gold color	R, T, K models
	Black color	U, C, R, A, G, E, F models
[HTR-6180]	Titanium color	G, E, F, L models
	Black color	U, C, F models
[DSP-AX863J]	Gold color	J model
	Black color	J model
[DSP-AX863SE]	Black color	J model
	Titanium color	B model
	Titanium color	B model

Accessories / 付属品
 Remote control x 1, Batteries (R6, AA, UM-3) x 2 (U, C, R, T, A, L, J models) / (R03, AAA, UM-4) x 4 (K, B, G, E, F models), Indoor FM antenna x 1 (U, C, R, T, K, A, G, E, F, L, J models), AM loop antenna x 1 (U, C, R, T, K, A, G, E, F, L, J models), Optimizer microphone x 1, Power cable x 1 (J model)

* Specifications are subject to changes without notice due to product improvements.
 ※ 参考仕様および外觀は予告なく変更されることがあります。

DDOLBY DIGITAL PLUS
 TRUEHD
 Manufactured under license from Dolby Laboratories. "Dolby", "Pro Logic", and the double-D symbol are trademarks of Dolby Laboratories.
 Dolby Pro Logic II, "Surround EX"およびデジタルD配音は、ドルビーラボラトリーからの実権に基づき製造されています。【ドルビー】、【PRO LOGIC II】、【Surround EX】およびデジタルD配音は、ドルビーラボラトリーの商標です。

DTS-HD
 Master Audio
 DTS is a registered trademark and the DTS logo, Symbol, DTS-HD and DTS-HD Master Audio are trademark of DTS, Inc.
 DTSはDTS社の登録商標です。また、DTSロゴ、記号、およびDTS-HD、DTS-HD Master AudioはDTS社の商標です。

iPod™
 "iPod" is a trademark of Apple Inc., registered in the U.S. and other countries.
 iPodは、米国およびその他の国々で登録されたApple Inc.の商標または登録商標です。

Bluetooth™
 Bluetooth is a registered trademark of the Bluetooth SIG and is used by Yamaha in accordance with a license agreement.
 Bluetoothは、Bluetooth SIGの登録商標でありヤマハはライセンスに基づき使用しています。

HDMI
 "HDMI", the "HDMI" logo and "High-Definition Multimedia Interface" are trademarks or registered trademarks of HDMI Licensing LLC.
 HDMI, HDMIロゴ、およびHigh-Definition Multimedia Interfaceは、HDMI Licensing, LLCの商標または登録商標です。

X.v.Color™
 "X.v.Color" is a trademark of Sony Corporation.
 "X.v.Color"は、ソニー株式会社の商標です。

SILENT™ CINEMA
 "SILENT CINEMA" is a trademark of Yamaha Corporation.
 「サイレントシネマ」TM SILENT CINEMATMはヤマハ株式会社の登録商標です。

XM HD XM MINI TUNER
 The XM name and related logos are registered trademarks of XM Satellite Radio Inc.

Neural Surround
 Neural Surround™ name and related logos are trademarks owned by Neural Audio Corporation.

SIRIUS SATELLITE RADIO
 ©2006 SIRIUS Satellite Radio Inc. "SIRIUS", "SiriusConnect", the SIRIUS dog logo, channel names and logos are trademarks of SIRIUS Satellite Radio Inc.

HD Radio
 HD Radio™ Technology Manufactured Under License From Ibisquity Digital Corp. U.S. and Foreign Patents. HD Radio™ and the HD Radio logo are proprietary trademarks of Ibisquity Digital Corp.

SRS COOL
 Circle Surround II, Dialog Clarity, TruBass, SRS and the SRS symbol are trademarks of SRS Labs, Inc.
 Circle Surround II, Dialog Clarity and TruBass technologies are incorporated under license from SRS Labs, Inc.

AAC
 AACコアテクノロジーはドルビーラボラトリーの商標です。

● DIMENSIONS / 寸法図

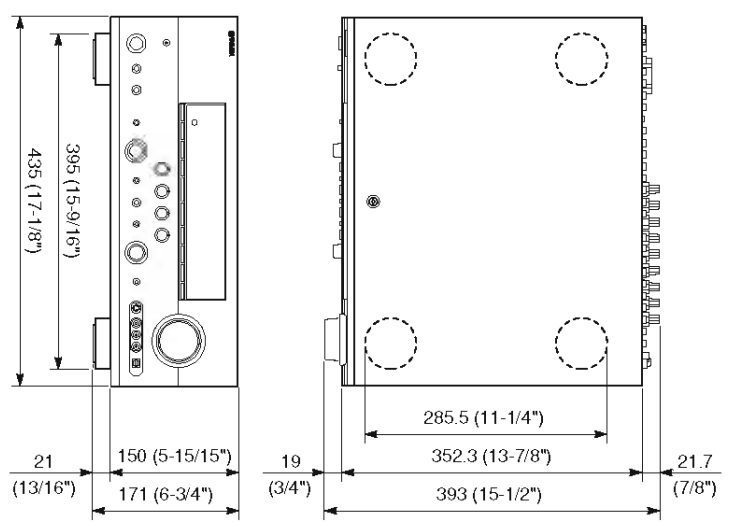

● SCENE TEMPLATE

SCENE name	Contents	Source	Program		NIGHT Mode	Select (Default)
			Mode	Sub-mode		
DVD Viewing	DVD	Movie	DVD STRAIGHT	-	SYSTEM	U, C models O (SCENE 1)
DVD Movie Viewing		DVD	DVD MOVIE	Sci-Fi	SYSTEM	O (SCENE 1)
DVD Live Viewing		DVD	DVD ENTERTAINMENT	Music Video	SYSTEM	O (SCENE 1)
DVR Viewing	DVR	DVR	DVR MOVIE	Drama	SYSTEM	O (SCENE 1)
Disc Hi-Fi Listening	DVD-Audio / SA-CD / CD	Music Disc	DVD PURE DIRECT	-	SYSTEM	O (SCENE 2)
Music Disc Listening		DVD	DVD STEREO	2ch Stereo	SYSTEM	O (SCENE 2)
Disc Listening	CD	Music Disc	CD PURE DIRECT	-	SYSTEM	O (SCENE 2)
CD Hi-Fi Listening		CD	CD STEREO	7ch Stereo	SYSTEM	O (SCENE 2)
CD Listening		CD	CD STEREO	2ch Stereo	SYSTEM	O (SCENE 2)
CD Music Listening		CD	CD STEREO	2ch Stereo	SYSTEM	O (SCENE 2)
Radio Listening	TUNER/RADIO	FM/AM	FM/AM (TUNER)	7ch Enhancer	SYSTEM	O (SCENE 4)
XM Listening		XM	XM MUSIC ENHANCER	7ch Enhancer	SYSTEM	O (SCENE 4)
SIRIUS Listening		SIRIUS	SIRIUS MUSIC ENHANCER	7ch Enhancer	SYSTEM	O (SCENE 4)
Dock Listening	DAP	iPod / Bluetooth	DOCK MUSIC ENHANCER	7ch Enhancer	SYSTEM	O (SCENE 4)
TV Viewing	TV		DTV/CBL STRAIGHT	-	SYSTEM	O (SCENE 3)
TV Sports Viewing			DTV/CBL ENTERTAINMENT	Sports	SYSTEM	O (SCENE 3)
Action Game Playing	GAME	Action	V-AUX ENTERTAINMENT	Action Game	SYSTEM	O (SCENE 3)
RPG Playing		RPG	V-AUX ENTERTAINMENT	Roleplaying Game	SYSTEM	O (SCENE 3)
LP Record Listening	LP Record	LP	PHONO PURE DIRECT	-	SYSTEM	O (SCENE 3)

• SET MENU TABLE / セットメニュー

CATEGORY	MAIN MENU	SUB MENU	SELECT MENU	VALUE [INITIAL]		
AUTO SETUP	Use this feature to automatically adjust speaker and system parameters. 本機に搭載の「YPAO」により、お使いになるスピーカーの配置や性能、お部屋の音響特性を測定し、最適な視聴空間を自動的に設定します。					
MANUAL SETUP	1 BASIC MENU	A) SPEAKER SET	EXTRA FRONT B	ZONE2 / [FRONT B] / ZONE B / PRNS / NONE		
			BASS OUT BOTH	[BOTH] / SWFR / FRONT		
			FRONT LARGE	[LARGE] / SMALL		
			CENTER SMALL	LARGE / [SMALL] / NONE		
			SUR. L/R SMALL	LRGx1 / LRGx2 / SMLx1 / [SMLx2] / NONE		
			SUR. B SMLx2	40 / 60 / [80] / 90 / 100 / 110 / 120 / 160 / 200 Hz		
			CROSSOVER 80Hz	[NRM (normal)] / REV (reverse)		
		SWFR PHASE NRM				
		B) SP LEVEL	FL	----- -----	-10.0 to +10.0 dB, [0 dB], 0.5 dB step	
			FR	----- -----		
			C	----- -----		
			SL	----- -----		
			SR	----- -----	-10.0 to +10.0 dB, [-1.0 dB], 0.5 dB step	
			SBL	----- -----		
			SBR	----- -----		
		C) SP DISTANCE	SWFR	----- -----		
			PL	----- -----	-10.0 to +10.0 dB, [0 dB], 0.5 dB step	
			PR	----- -----		
			UNIT	feet	feet (ft) / meters (m)	
			FRONT L	10.0ft	feet: 1.0 to 80.0 ft [10.0 ft], 0.5 ft step	
			FRONT R	10.0ft		
			CENTER	8.5ft	feet: 1.0 to 80.0 ft [8.5 ft], 0.5 ft step	
		UNIT: feet	SUR. L	8.0ft		
			SUR. R	8.0ft	feet: 1.0 to 80.0 ft [8.0 ft], 0.5 ft step	
			SBL	8.0ft		
			SBR	8.0ft		
			SWFR	10.0ft		
			PRNS L	10.0ft	feet: 1.0 to 80.0 ft [10.0 ft], 0.5 ft step	
			PRNS R	10.0ft		
			UNIT: meters	FRONT L	3.00m	meters: 0.30 to 24.00 m [3.00 m], 0.10 m step
				FRONT R	3.00m	
				CENTER	2.60m	meters: 0.30 to 24.00 m [2.60 m], 0.10 m step
				SUR. L	2.40m	
				SUR. R	2.40m	meters: 0.30 to 24.00 m [2.40 m], 0.10 m step
				SBL	2.40m	
				SBR	2.40m	
		SWFR		3.00m		
	PRNS L	3.00m		meters: 0.30 to 24.00 m [3.00 m], 0.10 m step		
	PRNS R	3.00m				
	D) TEST TONE	> OFF ON		[OFF] / ON		
2 VOLUME MENU	ADPTV DRG	OFF		AUTO / [OFF]		
	ADAPT DSP	OFF				
	MUTE TYP.	FULL		[FULL] / -20 dB		
	MaxVol.	+16.5dB	-30.0 to +15.0 dB / +16.5 dB, [+16.5 dB], 5.0 dB step			
	IniVol.	OFF	OFF / MUTE / -80.0 to +16.5 dB, [OFF], 0.5 dB step			
3 SOUND MENU	A) EQUALIZER	EQ SELECT	GEQ	AUTO PEQ / [GEQ] / OFF		
		CHANNEL	FRNT L / FRNT R / CENTER / SUR. L / SUR. R / SBL / SBR / SWFR / PRNS L / PRNS R			
		63 Hz	--- ---			
		160 Hz	--- ---			
		400 Hz	--- ---			
		1 kHz	--- ---	-0.6 to +6.0 dB, [0 dB], 0.5 dB step		
		2.5 kHz	--- ---			
	6.3 kHz	--- ---				
	16 kHz	--- ---				
	TEST TONE	OFF	[OFF] / ON			
	B) LFE LEVEL	SP LFE		-20 to 0 dB, [0 dB], 1 dB step		
		HP LFE				
	C) D. RANGE	SP		MIN/AUTO / STD / [MAX]		
		HP				
	D) LIPSYNC	HDMI AUTO	OFF	ON / [OFF]		
	AUTO	--- ms				
	MANUAL	0 ms	0 to 240 ms, [0 ms], 1 ms step			
E) EXTD SUR.	EXTD	AUTO	[AUTO] / PLIIXMovie / PLIIXMusic / EX/ES / EX / OFF			
4 INPUT MENU (U, C models)	A) SIRIUS	Item that can be set. / 設定可能項目: [2], [3], [5]				
	B) XM	: [2], [3]				
	C) PHONO	: [1], [2], [3]				
	D) TUNER	: [2], [3]				
	E) CD	: [1], [2], [3], [4]				
	F) MD/CD-R	: [1], [2], [3], [4]				
	G) DVD	: [1], [2], [3], [4]				
	H) DTV/CBL	: [1], [2], [3], [4]				
	I) V-AUX	: [1], [2], [3], [4]				
	J) DOCK	: [2], [3], [6]				
	K) BLUETOOTH	: [2], [3], [7]				
	L) DVR	: [1], [2], [3], [4]				
	M) VCR	: [1], [2], [3]				
	N) MULTI CH	: [2], [3], [8], [9], [10]				
	(U, C models)	[1] I/O ASSIGNMENT	COAX. IN NONE	NONE / CD / DVD		
			OPT. IN NONE	NONE / MD/CD-R / DVD / DTV/CBL		
			OPT. OUT NONE	NONE / MD/CD-R		
		[2] INPUT RENAME	Input is possible to 9 characters / 9文字まで入力可能 Input possible Character type / 入力可能文字 Capital / 英大文字: A to Z Small / 英小文字: a to z Figure / 数字: 0 to 9 Space / 空白 Marks / 記号: # * + , - . / : < > ?			
		[3] V. TRIM	0.0dB	-6.0 to +6.0 dB, [0.0 dB], 0.5 dB step		
		[4] DECODER	AUTO	[AUTO] / DTS		
[5] PARENTAL LOCK						
[6] CHARGE		AUTO	[AUTO] / OFF			
[7] START PAIRING						
[8] BGV		LAST	[LAST] / DVD, DTV/CBL, DVR, VCR, V-AUX / OFF			
[9] INPUT CH	6ch	[6ch] / 8ch				
[10] FRONT	DVD	CD / MD/CD-R / [DVD] / DTV/CBL / DVR / VCR / V-AUX * Setting is possible only when 8ch is selected using [9] (INPUT CH). / [9] (INPUT CH) で 8ch 選択時のみ設定可				
5 OPTION MENU	A) DISPLAY SET	DIMMER	0	-4 to 0, [0], 1 step		
		OSD SHIFT	0	-5 (downward) to +5 (upward), [0], 1 step		
		OSD-SOURCE	30s			
		OSD-AMP	30s	ON / 10s / 30s		
		FL SCROLL	COTN	[CONT] / ONCE		
	B) VIDEO SET	VIDEO CONV.	ON	[ON] / OFF		
		HDMI RES.	*THRGH	*THROUGH / *480p (*576p) / *720p / *1080i / *1080p		
		HDMI ASPECT		THRGH / 16:9 / SMART		
	C) MEMORY GUARD	MEM. GUARD	OFF	[OFF] / ON		
	D) INIT. CONFIG	A. SELECT	AUTO			
		DECODER	AUTO	[AUTO] / LAST		
		EXTD SUR.	AUTO			
	E) HDMI SET	HDMI CONTROL	OFF	ON / [OFF]		
		S. AUDIO	V863	[V863 / 6180 / AX863SE / AX863] / OTHER		
		STANDBY THROUGH	OFF	ON / [OFF]		
F) ZONE2 SET	MAX VOL.	+16.5dB	-30.0 to +15.0 dB / +16.5 dB, [+16.5 dB], 5.0 dB step			
	INI. VOL.	OFF	OFF / MUTE / -80.0 to +16.5 dB, [OFF], 0.5 dB step			
SIGNAL INFO	AUDIO	FORMAT (Signal format)		Analog / ----- / ----- / ----- / ----- / -----		
		SAMPLING				
		CHANNEL				
		BITRATE		3/2/0.1 (front/surround/LFE)		
		DIALOG				
	FLAG		DTS, Dolby Digital, or PCM			
	VIDEO	HDMI SIGNAL		xxx -> xxx		
		HDMI RES.		1080p -> 1080p		
		ANALOG RES.		480/576i		
		HDMI ERROR (HDMI MESSAGE)		DEVICE OVER / HDCP ERROR / Out of Res.		

INTERNAL VIEW

Top View

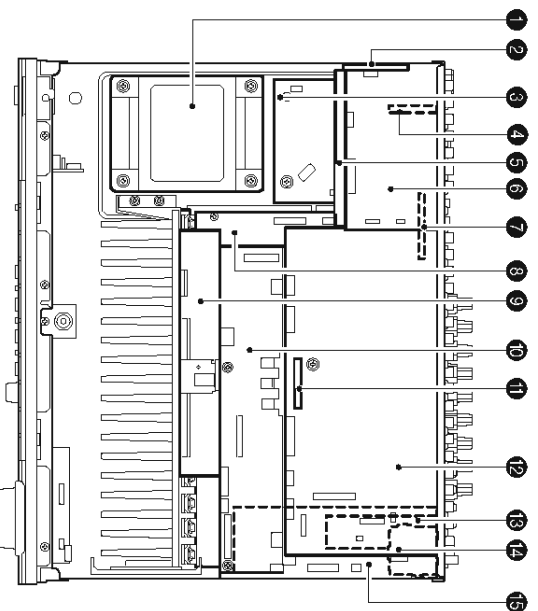

- 1 POWER TRANSFORMER
- 2 FUNCTION (6) P.C.B.
- 3 FUNCTION (3) P.C.B.
- 4 FUNCTION (2) P.C.B. (J model)
- 5 VIDEO (2) P.C.B.
- 6 VIDEO (1) P.C.B.
- 7 FUNCTION (4) P.C.B. (R, L models)
- 8 MAIN (1) P.C.B.
- 9 MAIN (2) P.C.B.
- 10 DIGITAL P.C.B.
- 11 FUNCTION (9) P.C.B.
- 12 FUNCTION (1) P.C.B.
- 13 Tuner (C, R, T, K, A, G, E, F, L, J models)
- 14 FUNCTION (5) P.C.B. (B model)
- 15 HD Radio (U model)
- 16 OPERATION (2) P.C.B.
- 17 OPERATION (3) P.C.B.
- 18 OPERATION (1) P.C.B.
- 19 OPERATION (4) P.C.B.
- 20 OPERATION (5) P.C.B.

Front View

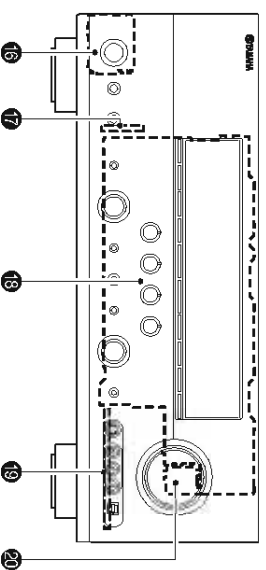

DISASSEMBLY PROCEDURES / 分解手順

(Remove parts in the order as numbered.)
Disconnect the power cable from the AC outlet.

(番号順に部品を取り外してください。)
AC電源コンセントから、電源コードを抜いてください。

1. Removal of Top Cover

- a. Remove 4 screws (①), 5 screws (②) and screw (③). (Fig. 1)
- b. Slide the top cover rearward to remove it. (Fig. 1)

1. トップカバーの外し方
 - a. ①のネジ4本、②のネジ5本、③のネジ1本を外します。(Fig. 1)
 - b. トップカバーを後方へスライドさせ、取り外します。(Fig. 1)

2. Removal of Front Panel Unit

- a. Remove 2 knobs. (Fig. 1)
- b. Remove screw (④) and then remove the support top. (Fig. 1)
- c. Remove 6 screws (⑤). (Fig. 1)
- d. Remove the front panel unit. (Fig. 1)

2. フロントパネルユニットの外し方

- a. ノブを2個取り外します。(Fig. 1)
- b. ④のネジ1本を外し、サポートトップを取り外します。(Fig. 1)
- c. ⑤のネジ6本を外します。(Fig. 1)
- d. フロントパネルユニットを取り外します。(Fig. 1)

3. Removal of Sub Chassis Unit

- a. Remove 2 push rivets (⑥). (Fig. 1)
- b. Remove the plate side L and plate side R. (Fig. 1)
- c. Remove 2 screws (⑦). (Fig. 1)
- d. Remove CB30, CB46, CB63, CB201, CB221 and CB422. (Fig. 1)
- e. Remove the sub chassis unit. (Fig. 1)

3. サブシャーシユニットの外し方

- a. ⑥のプッシュリベット2本を外します。(Fig. 1)
- b. プレートサイドLおよびプレートサイドRを取り外します。(Fig. 1)
- c. ⑦のネジ2本を外します。(Fig. 1)
- d. CB30、CB46、CB63、CB201、CB221、CB422を外します。(Fig. 1)
- e. サブシャーシユニットを取り外します。(Fig. 1)

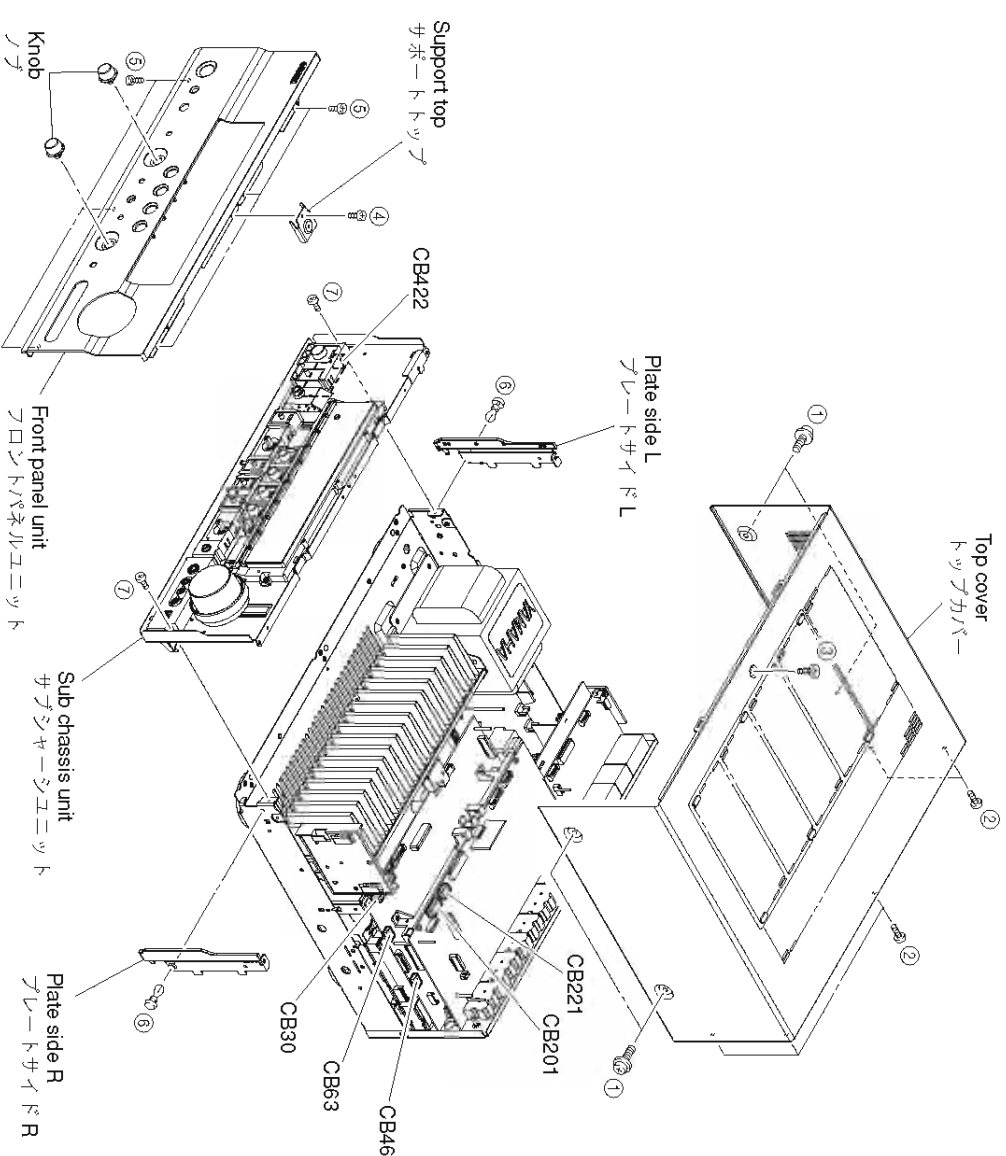

Fig. 1

4. Removal of FUNCTION (1) P.C.B.

- a. Remove 2 push rivets (⑨). (Fig. 2)
- b. Remove 10 screws (RX-V863: U, C, R, T, K, A, G, E, F, L models / HTR-6180: U, F models) / 9 screws (HTR-6180: C model / DSP-AX863SE: B model) (⑩). (Fig. 3)
- c. Remove CB39 (RX-V863: U, C models / HTR-6180: U model), CB205, CB206, CB231, CB232, CB242 (C, R, T, K, A, G, E, F, L models), CB243 (DSP-AX863SE: B model), CB244 (U model), CB245 (U model) and CB302. (Fig. 2)
- d. Remove the FUNCTION (1) P.C.B.. (Fig. 2)

4. FUNCTION (1) P.C.B.の外し方

- a. ⑨のナジ9本を外します。(Fig. 2)
- b. ⑩のナジ9本を外します。(Fig. 3)
- c. CB205、CB206、CB231、CB232、CB242、CB302を外します。(Fig. 2)
- d. FUNCTION(1) P.C.B.を取り外します。(Fig. 2)

5. Removal of DIGITAL P.C.B.

- a. Remove 2 screws (⑩). (Fig. 2)
- b. Remove 12 screws (RX-V863: U, C models / HTR-6180: U model) / 10 screws (RX-V863: R, T, K, A, G, E, F, L models / HTR-6180: C, F models / DSP-AX863SE: B model) (⑪). (Fig. 3)
- c. Remove CB31-33, CB62 and CB80-82. (Fig. 2)
- d. Remove the DIGITAL P.C.B.. (Fig. 2)

5. DIGITAL P.C.B.の外し方

- a. ⑩のナジ2本を外します。(Fig. 2)
- b. ⑪のナジ10本を外します。(Fig. 3)
- c. CB31-33、CB38、CB62、CB80-82を外します。(Fig. 2)
- d. DIGITAL P.C.B.を取り外します。(Fig. 2)

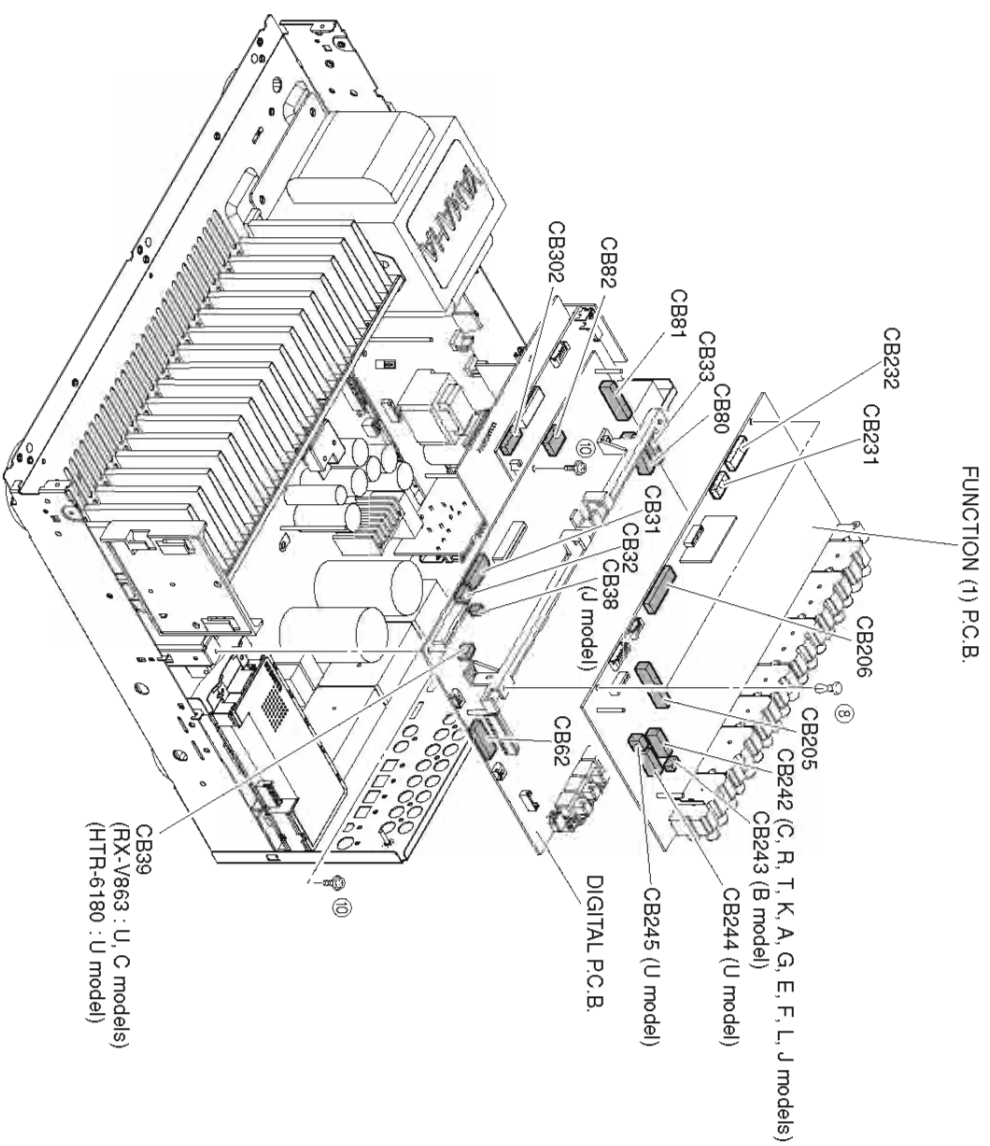

**RX-V863 (U, C, R, T, K, A, G, E, F, L models)
HTR-6180 (U, C, F models)**

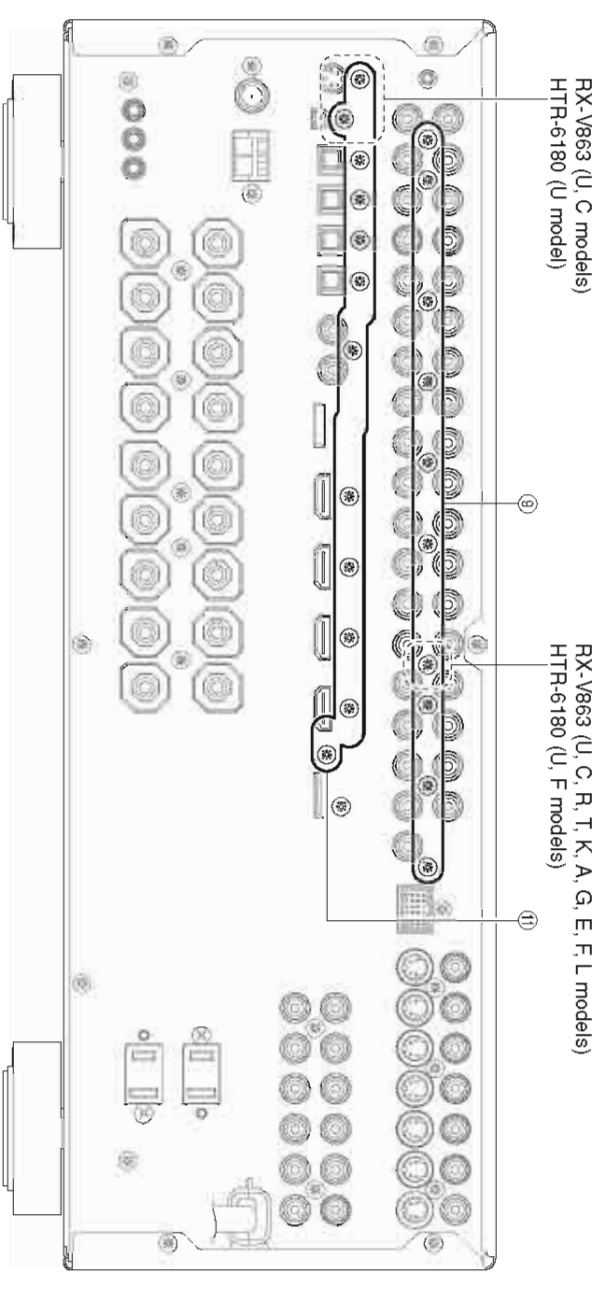

**DSP-AX863SE (B model)
DSP-AX863 (J model)**

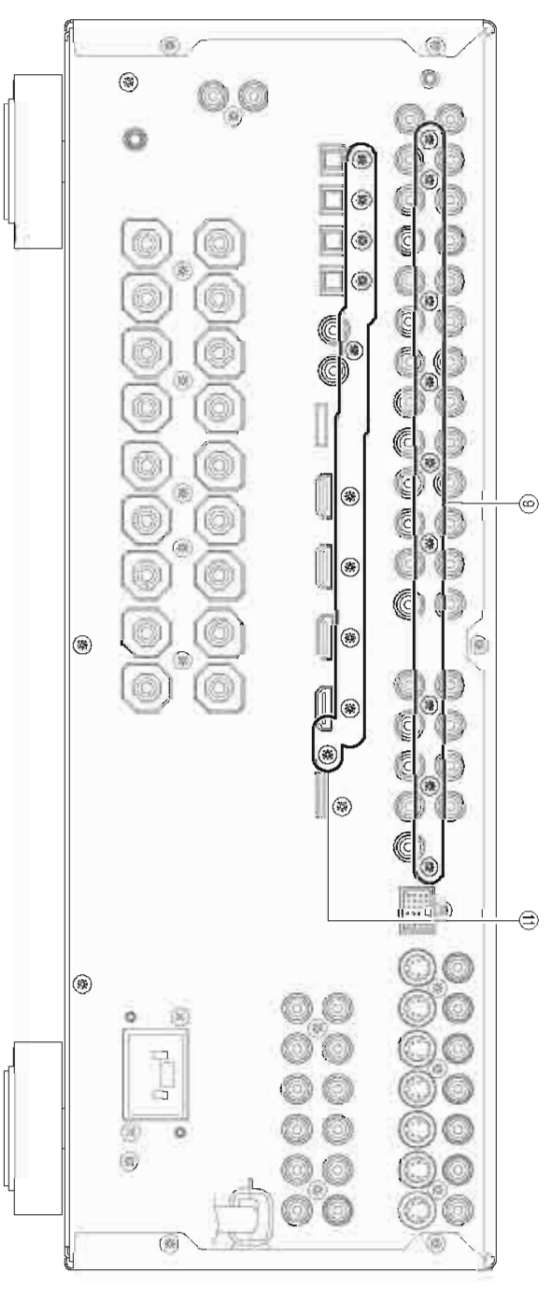

Fig. 2

Fig. 3

6. **Removal of VIDEO (1) and (2) P.C.B.s**
 - a. Remove 2 screws (12) and then remove the FUNCTION (6) P.C.B. which is connected directly to the VIDEO (1) and (2) P.C.B.s with board to board connectors. (Fig. 4)
 - b. Remove 4 screws (13). (Fig. 5)
 - c. Remove CB303. (Fig. 4)
 - d. Remove the VIDEO (1) P.C.B.. (Fig. 4)
 - e. Remove 3 screws (14). (Fig. 5)
 - f. Remove the VIDEO (2) P.C.B.. (Fig. 4)

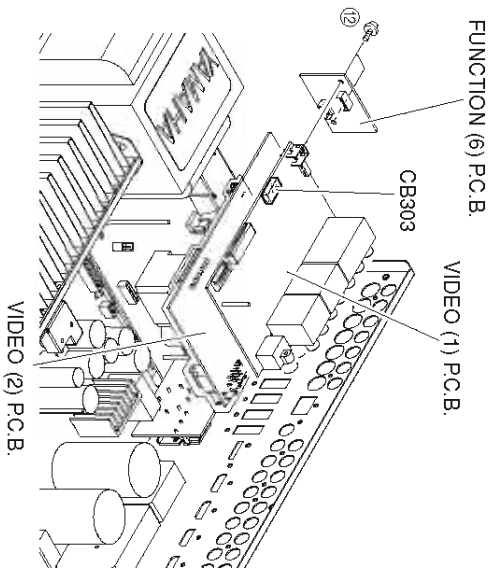

Fig. 4

6. **VIDEO (1)、(2)P.C.B.の外し方**
 - a. ⑫のネジ2本を外し、FUNCTION(6)P.C.B.を取り外します。(Fig. 4)
ただし、FUNCTION(6)P.C.B.は、VIDEO(1)、(2)P.C.B.に基板対基板コネクタで直接接続されています。(Fig. 4)
 - b. ⑬のネジ4本を外します。(Fig. 5)
 - c. CB303を外します。(Fig. 4)
 - d. VIDEO(1)P.C.B.を取り外します。(Fig. 4)
 - e. ⑭のネジ3本を外します。(Fig. 5)
 - f. VIDEO(2)P.C.B.を取り外します。(Fig. 4)

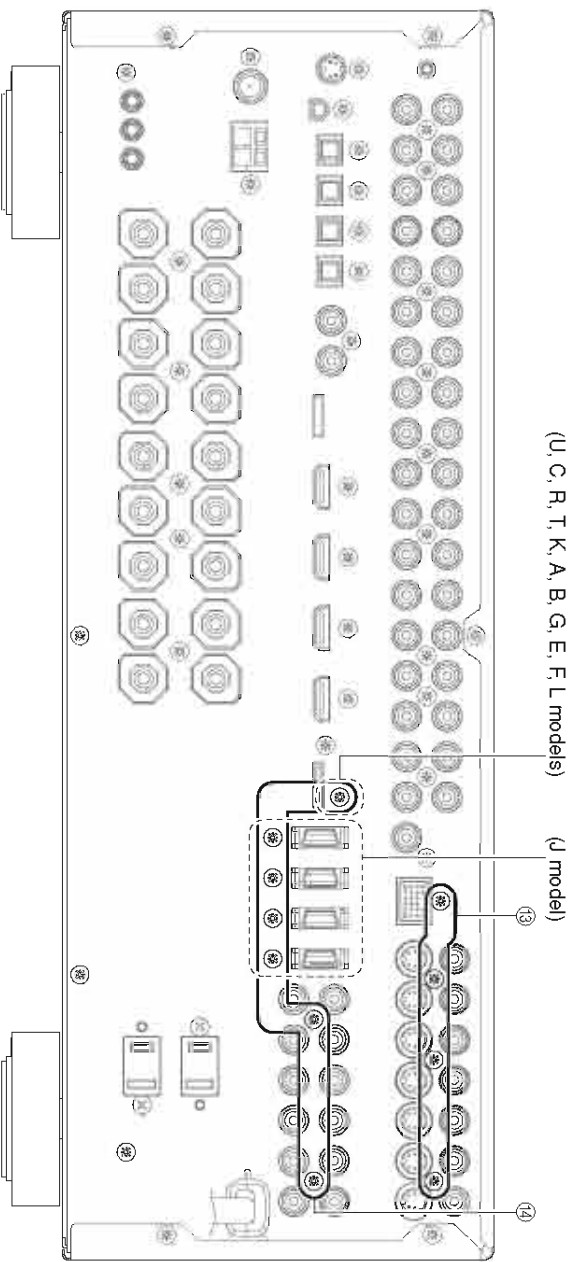

Fig. 5

7. **Removal of HD Radio Tuner (U model)**
 - a. Remove 2 screws (15) and 2 screws (16). (Fig. 6)
 - b. Remove the HD radio tuner and support radio tuner. (Fig. 6)

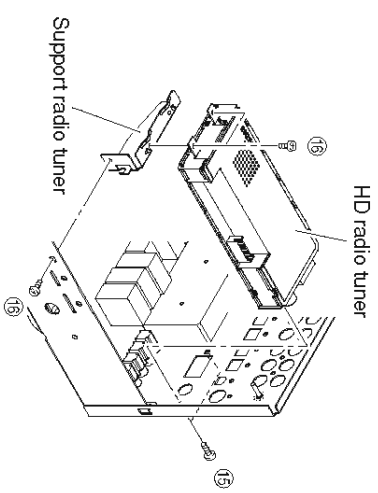

Fig. 6

8. **Removal of AM/FM Tuner (RX-V863: C, R, T, K, A, G, E, F, L models / HTR-6180: C, F models)**
 - a. Remove 2 screws (17). (Fig. 7)
 - b. Remove the AM/FM tuner. (Fig. 7)

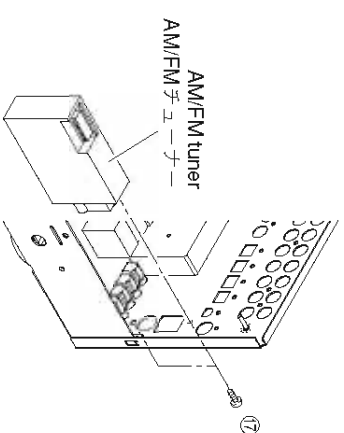

Fig. 7

8. **AM/FMチューナーの外し方**
 - a. ⑰のネジ2本を外します。(Fig. 7)
 - b. AM/FMチューナーを取り外します。(Fig. 7)

9. **Removal of FUNCTION (5) P.C.B. (B model)**
 - a. Remove screw (18). (Fig. 8)
 - b. Remove the FUNCTION (5) P.C.B.. (Fig. 8)

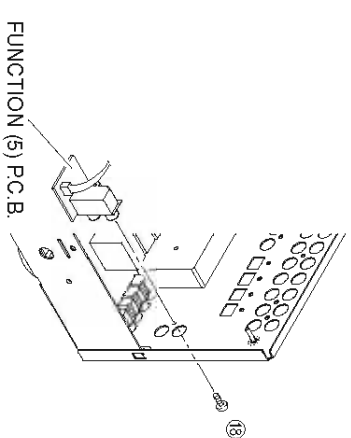

Fig. 8

10. Removal of Amp Unit

- a. Remove 2 screws (19), screw (20), 2 screws (21) and screw (22). (Fig. 9)
- b. Remove 6 screws (23). (Fig. 9)
- c. Remove CB100, CB101 and CB251. (Fig. 9)
- d. Remove the MAIN (1) and (2) P.C.B.s together with heat sink. (Fig. 9)

10. アンプユニットの外し方

- a. ⑱のネジ2本、⑳のネジ1本、㉑のネジ2本、㉒のネジ1本を外します。(Fig. 9)
- b. ㉓のネジ6本を外します。(Fig. 9)
- c. CB100、CB101、CB251を外します。(Fig. 9)
- d. MAIN(1)、(2)P.C.B.をヒートシンクと一緒に取り外します。(Fig. 9)

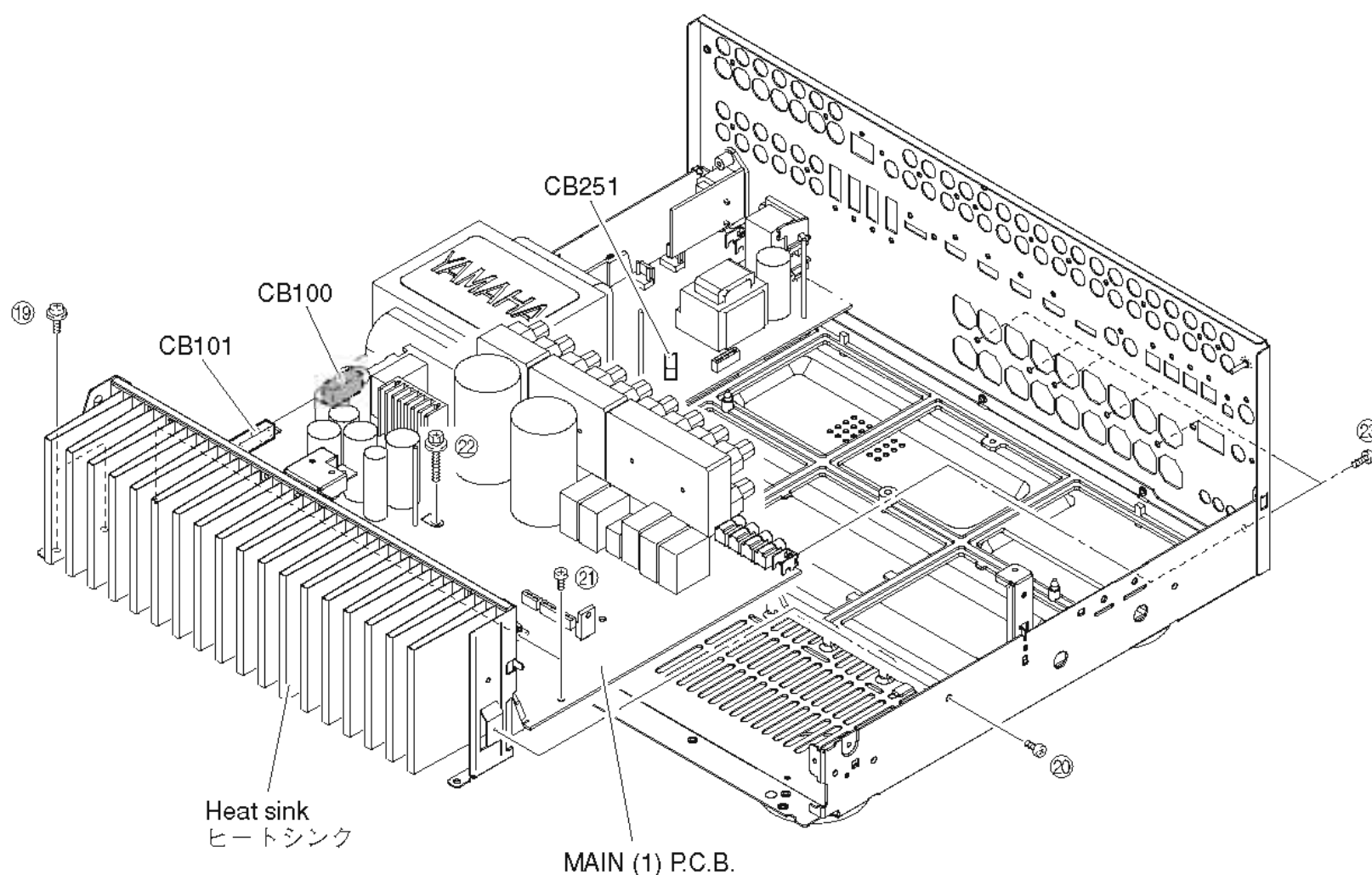

Fig. 9

When checking the P.C.B.:

- Put the rubber sheet and cloth over the equipment. Then place the FUNCTION(1) P.C.B. upside down on the cloth and check it. (Fig. 10)
- Reconnect all cables (connectors) that have been disconnected.
- When connecting the flexible flat cable, be careful with polarity.
- Be sure to use the extension cable for servicing for the following section. (Fig. 10)
 FUNCTION (1) P.C.B. CB205-DIGITAL P.C.B. CB61: MF125400 (25P, 400mm, P=1.25)
- In this unit, the ground of P.C.B.s shown below is connected to the rear panel and chassis. When FUNCTION (1) P.C.B. is removed from the rear panel and chassis, connect the ground point to the rear panel or chassis, using a ground lead or the like. (Fig. 10)
 FUNCTION (1) P.C.B.: PJ201 (PHONO)
 FUNCTION (1) P.C.B.: PJ203 (DVD)
 FUNCTION (1) P.C.B.: PJ209 (PRE OUT)
 FUNCTION (1) P.C.B.: PJ294 (SUBWOOFER2)

P.C.B.チェックをする場合には:

- 本機の上にゴムシートと布を敷き、その上に FUNCTION(1) P.C.B. を裏返しに置いてチェックします。(Fig. 10)
- 外したケーブル(コネクター)をすべて接続します。
- フラットケーブルを接続する際、極性に注意してください。
- 次の区間は、サービス用延長ケーブルを使用してください。(Fig. 10)
 FUNCTION(1) P.C.B. CB205-DIGITAL P.C.B. CB61: MF125400 (25P、400mm、P=1.25)
- 本機ではP.C.B.のアースがリアパネルおよびシャーシに接続されています。FUNCTION(1) P.C.B.をリアパネルおよびシャーシより取り外した場合、リード線等でアースポイントをリアパネルまたはシャーシに接続してください。(Fig. 10)
 FUNCTION(1) P.C.B.: PJ201 (PHONO)
 FUNCTION(1) P.C.B.: PJ203 (DVD)
 FUNCTION(1) P.C.B.: PJ209 (PRE OUT)
 FUNCTION(1) P.C.B.: PJ294 (SUBWOOFER2)

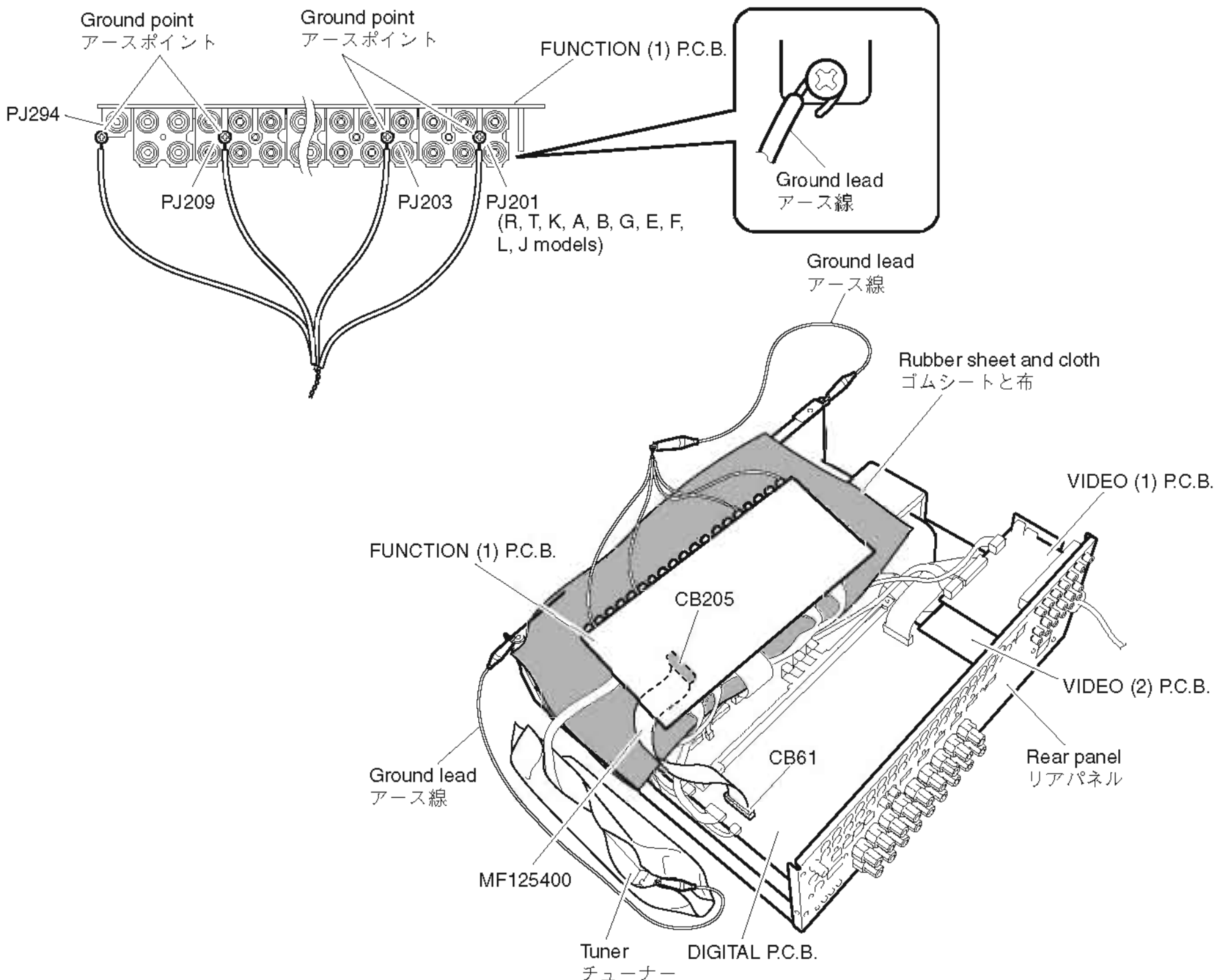

Fig. 10

When checking the P.C.B.:

- Put the rubber sheet and cloth over the equipment. Then place the FUNCTION(1) and DIGITAL P.C.B.s upside down on the cloth and check it. (Fig. 11)
 - Reconnect all cables (connectors) that have been disconnected.
 - When connecting the flexible flat cable, be careful with polarity.
 - Be sure to use the extension cable for servicing for the following section. (Fig. 11)
 - FUNCTION (1) P.C.B. CB205-DIGITAL P.C.B. CB61: MF125400 (25P, 400mm, P=1.25)
 - DIGITAL P.C.B. CB80-VIDEO (1) P.C.B. CB305: MF126500 (26P, 500mm, P=1.25)
 - DIGITAL P.C.B. CB81-VIDEO (2) P.C.B. CB302: MF116400 (16P, 400mm, P=1.25)
 - In this unit, the ground of P.C.B.s shown below is connected to the rear panel and chassis.
- When FUNCTION(1) P.C.B. is removed from the rear panel or chassis, connect the ground point to the rear panel or chassis, using a ground lead or the like. (Fig. 11)
- FUNCTION (1) P.C.B.: PJ201 (PHONO)
 - FUNCTION (1) P.C.B.: PJ203 (DVD)
 - FUNCTION (1) P.C.B.: PJ209 (PRE OUT)
 - FUNCTION (1) P.C.B.: PJ294 (SUBWOOFER2)
 - DIGITAL P.C.B.: ST100
 - DIGITAL P.C.B.: PJ41 (DVD COAXIAL INPUT)
 - DIGITAL P.C.B.: G100, G300
 - DIGITAL P.C.B.: ST41 (XM) (U, C models)

P.C.B. チェックをする場合には:

- 本機の上にゴムシートと布を敷き、その上に FUNCTION(1)P.C.B.およびDIGITAL P.C.B.を裏返しに置いてチェックします。(Fig. 11)
- 外したケーブル(コネクタ)をすべて接続します。
- フラットケーブルを接続する際、極性に注意してください。
- 次の区間は、サービスイテンス用延長ケーブルを使用してください。(Fig. 11)
- FUNCTION(1)P.C.B. CB205-DIGITAL P.C.B. CB61: MF125400 (25P, 400mm, P=1.25)
- DIGITAL P.C.B. CB80-VIDEO(1)P.C.B. CB305: MF126500 (26P, 500mm, P=1.25)
- DIGITAL P.C.B. CB81-VIDEO(2)P.C.B. CB302: MF116400 (16P, 400mm, P=1.25)
- 本機ではP.C.B.のアースがリアパネルおよびシャーシに接続されています。
- FUNCTION(1)P.C.B.をリアパネルおよびシャーシより取り外した場合、リード線等でアースポイント(1)をリアパネルまたはシャーシに接続してください。(Fig. 11)
- FUNCTION(1)P.C.B.: PJ201 (PHONO)
- FUNCTION(1)P.C.B.: PJ203 (DVD)
- FUNCTION(1)P.C.B.: PJ209 (PRE OUT)
- FUNCTION(1)P.C.B.: PJ294 (SUBWOOFER2)
- DIGITAL P.C.B.: ST100
- DIGITAL P.C.B.: PJ41 (DVD COAXIAL INPUT)
- DIGITAL P.C.B.: G100, G300

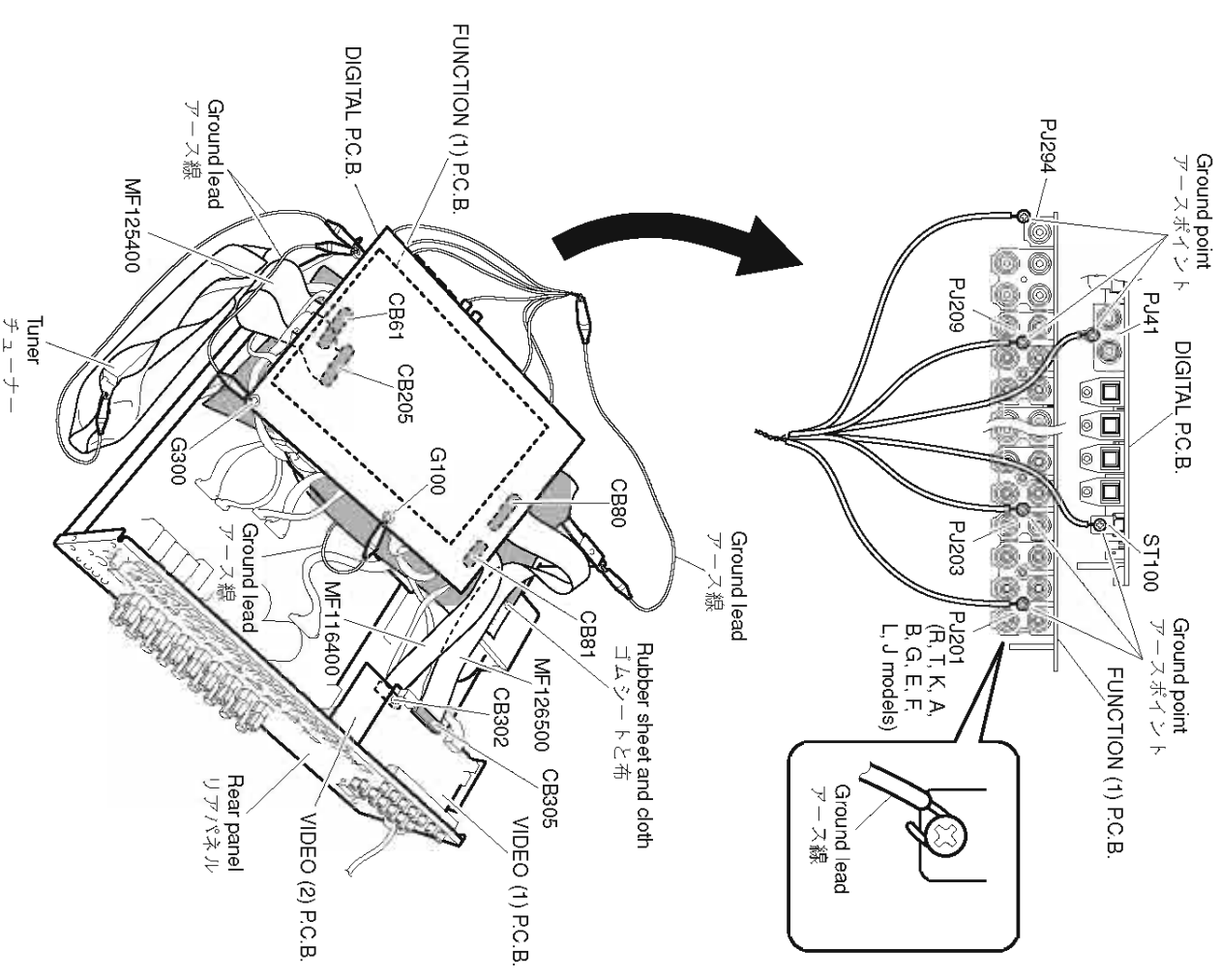

Fig. 11

■ UPDATING FIRMWARE / フォームウェアの書き込み

Note) Updating the firmware restores all the sound field parameters, system memory and tuner presetting, etc. to the original factory settings.

注意) フォームウェアの書き込みを行うと、音場プロファイルのパラメータやシステムメモリー、チューナープリセット等はすべて工場出荷時に初期化されます。

When replacing the following parts, be sure to write the latest firmware.

下記の部品をサービスマンに交換した場合、最新のフォームウェアの書き込みを行ってください。

P.C.B. ass'y DIGITAL P.C.B.
IC30 (Main microprocessor) of DIGITAL P.C.B.
IC51 (TI (DSP) flash ROM) of DIGITAL P.C.B.

P.C.B. ASSY : DIGITAL
DIGITAL P.C.B. : IC30(メインマイコン)
DIGITAL P.C.B. : IC51(TI(DSP)FLASH ROM)

There are 2 ways to write the firmware.

フォームウェアを書き込む方法は2通りあります。

- Writing method using the CD:
Transferring data using CD through digital inputs.
* When IC30 of DIGITAL P.C.B. is replaced, it is not possible to write the firmware by using the CD.
- Writing method using PC (RS232C):
Transferring data using PC through serial port (RS232C).

- CDを使用して書き込む方法:
CDを使用して書き込みを行うことができます。
※ DIGITAL P.C.B. IC30(メインマイコン)を交換した場合、CDでの書き込みはできません。
- PC (RS232C)を使用して書き込む方法:
PCを使用して書き込みを行うことができます。

Writing method using the CD

CDを使用して書き込む方法

● Required Tools

- DVD or CD player (with DIGITAL OUTPUT (OPTICAL or COAXIAL) jack)
- Optical cable (when OPTICAL jack is used)
- Digital audio pin cable (when COAXIAL jack is used)
- Firmware CD
* To make the firmware CD, download the latest firmware from the specified download source to PC.

● 必要なツール

- DVDまたはCDプレーヤー (DIGITAL OUTPUT (OPTICALまたはCOAXIAL) 端子付き)
- 光ファイバーケーブル (OPTICAL端子使用時)
- デジタル音声ピンケーブル (COAXIAL端子使用時)
- フォームウェアCD
※ フォームウェアCDは、PCへ最新のフォームウェアを指定のダウンロード先からダウンロードして制作してください。

● Operation Procedures

1. Connect this unit and DVD/CD player as shown below. (Fig. 1)

● 操作手順

1. 本機とDVD/CDプレーヤーを下記のように接続します。(Fig. 1)

Example of OPTICAL jack / OPTICAL端子使用例

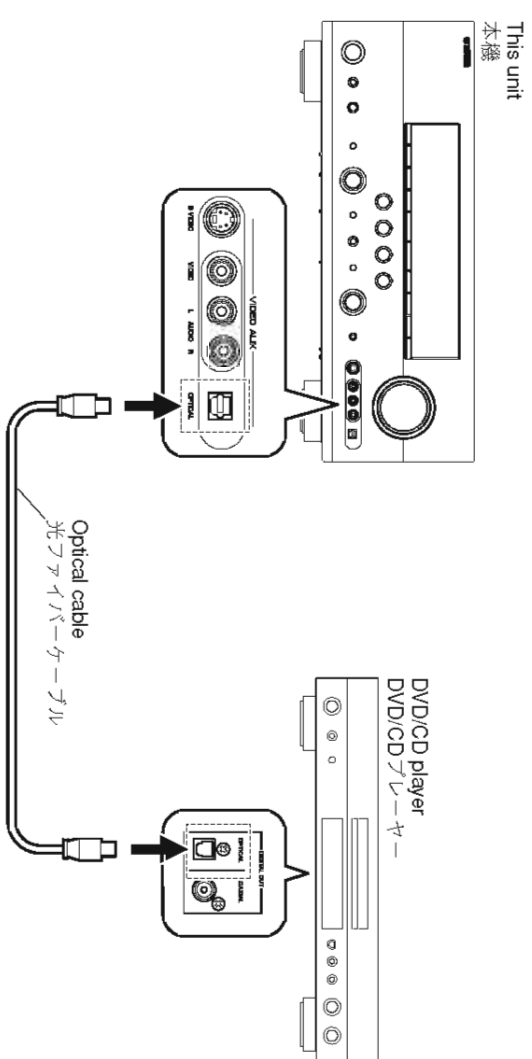

Example of COAXIAL jack / COAXIAL端子使用例

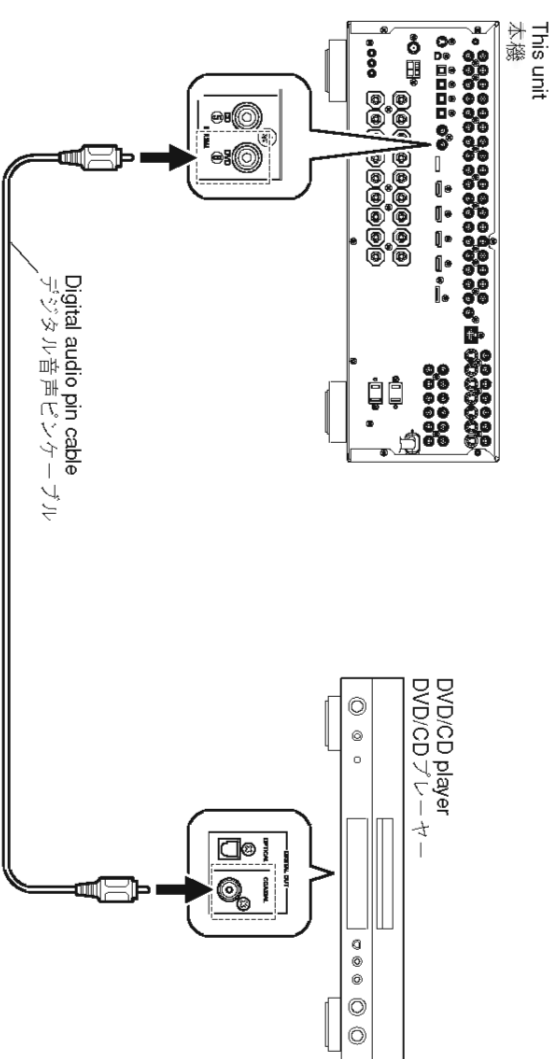

Fig. 1

2. While pressing the "TONE CONTROL" key of this unit, connect the power cable of this unit to the AC outlet. (Fig. 2)
The FIRMWARE UPDATE mode is activated and "CDDA Upgrader" is displayed. (Fig. 2)

2. 本機の"TONER CONTROL"キーを押しながら、本機の電源コードをACコンセントに接続します。(Fig. 2)
FIRMWARE UPDATEモードが起動し、"CDDA Upgrader"が表示されます。(Fig. 2)

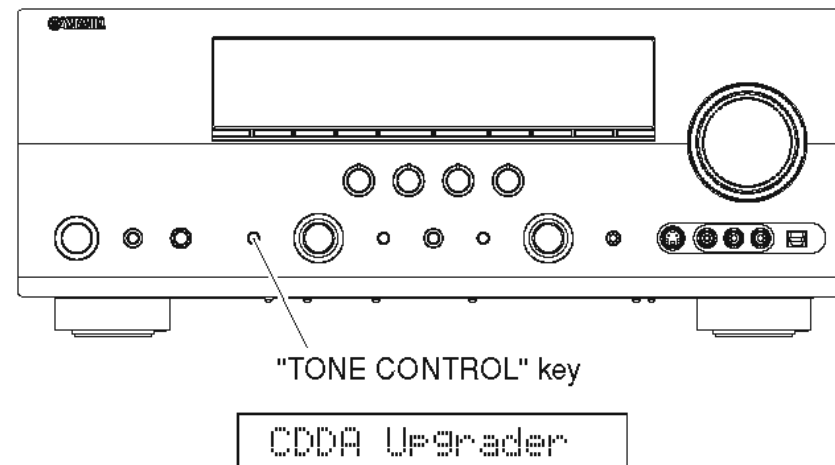

Fig. 2

3. Connect the power cable of DVD/CD player to the AC outlet.
4. Press the "STANDBY/ON" key of the DVD/CD player.
5. Press the "EJECT" key of the DVD/CD player to open the disc tray.
6. Put the firmware CD on the disc tray and close the disc tray.
7. Press the "PLAY" key of the DVD/CD player. Then writing of the firmware is started. (Fig. 3)
8. When writing of the firmware is completed, "Update Success", "Please..." and "Power off!!" are displayed repeatedly. (Fig. 3)

3. DVD/CDプレーヤーの電源コードをACコンセントに接続します。
4. DVD/CDプレーヤーの"STANDBY/ON"キーを押します。
5. DVD/CDプレーヤーの"EJECT"キーを押し、トレイを開きます。
6. ファームウェアCDをトレイに載せ、トレイを閉じます。
7. DVD/CDプレーヤーの"PLAY"キーを押します。ファームウェアの書き込みが開始されます。(Fig. 3)
8. ファームウェアの書き込み完了後、"Update Success"、"Please..."、"Power off!!"が繰り返し表示されます。(Fig. 3)

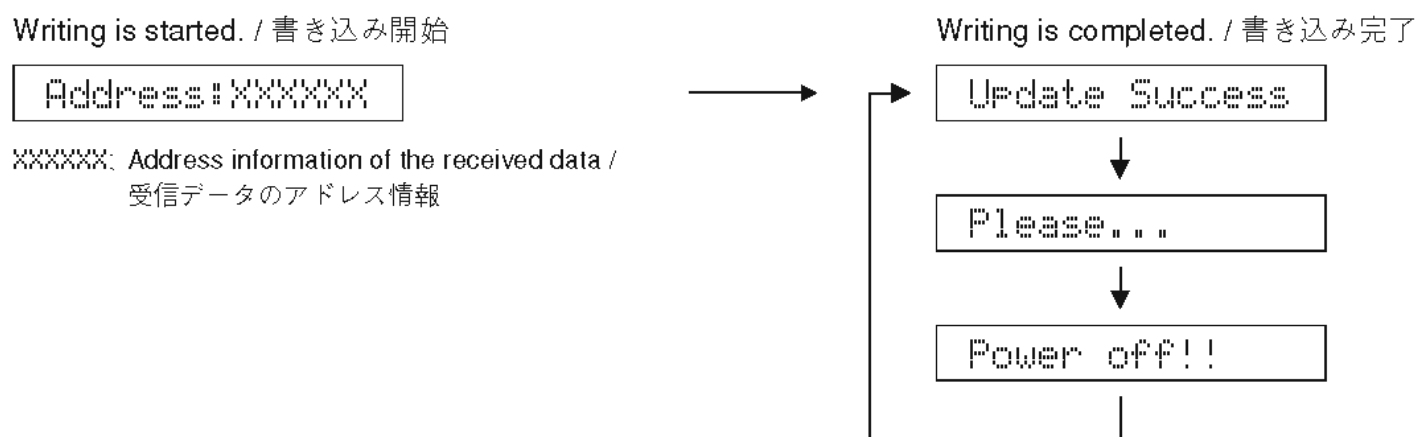

Fig. 3

* When the version of the firmware to be written is the same as the one existing in this unit, "Same Version", "Please..." and "Power off!!" are displayed repeatedly. (Upgrading is not necessary.)

If the display remains unchanged for more than 10 seconds after starting the firmware CD play procedure, perform the firmware CD play procedure again from the beginning.

If "FILE CORRUPTED" is displayed after "Address:XXXXXX", make sure that the written data is not corrupted and perform Steps 1 to 8 of "Operation Procedures" again.

If "Upgrade Failed" is displayed, perform Steps 1 to 8 of "Operation Procedures" again.

9. Press the "STOP" key of the DVD/CD player.
10. Press the "EJECT" key of the DVD/CD player to open the disc tray.
11. Remove the firmware CD from the disc tray and close the disc tray.
12. Turn off the power of the DVD/CD player and disconnect the power cable from the AC outlet.
13. Turn off the power by pressing the "MAIN ZONE ON/OFF" (RX-V863 / HTR-6180: U, F models) / "STANDBY/ON" (HTR-6180: C model / DSP-AX863SE) key of this unit.

● **Initializing of this unit**

- * After updating the firmware, be sure to initialize this unit.
1. Connect the power cable of this unit to the AC outlet.
 2. Press the "MAIN ZONE ON/OFF" (RX-V863 / HTR-6180: U, F models) / "STANDBY/ON" (HTR-6180: C model / DSP-AX863SE) key while simultaneously pressing the "STRAIGHT" and "AUDIO SELECT" keys. (Fig. 4)
Then the self-diagnostic function is activated.
 3. Select the self-diagnostic function menu "23. FACTORY PRESET".
 4. Select the "PRESET RSRV".

※ 本機に既存のファームウェアと、書き込もうとしているファームウェアのバージョンが同じ場合、“Same Version”、“Please...”、“Power off!!”の表示が繰り返されます。(バージョンアップの必要はありません。)

ファームウェアCDの再生開始後、10秒以上経過してもディスプレイ表示が変わらない場合、ファームウェアCDの再生を最初からやり直してください。

“Address:XXXXXX”の後に、“FILE CORRUPTED”が表示された場合、書き込みデータが破損していないかを確認し、“操作手順”の1から8までをもう一度やり直してください。

“Upgrade Failed”が表示された場合、“操作手順”の1から8までをもう一度やり直してください。

9. DVD/CDプレーヤーの“STOP”キーを押します。
10. DVD/CDプレーヤーの“EJECT”キーを押し、トレイを開きます。
11. ファームウェアCDをトレイから外し、トレイを閉じます。
12. DVD/CDプレーヤーの電源を切り、電源コードをACコンセントから抜きます。
13. 本機の“STANDBY/ON”キーを押して電源を切ります。

● **本機の初期化**

- ※ ファームウェアのアップデート後は、必ず本機を初期化してください。
1. 本機の電源コードをACコンセントに接続します。
 2. “STRAIGHT”キーと“AUDIO SELECT”キーを押しながら、“STANDBY/ON”キーを押し、ダイアグを起動します。(Fig. 4)
 3. ダイアグ“23. FACTORY PRESET”を選択します。
 4. “PRESET RSRV”を選択します。

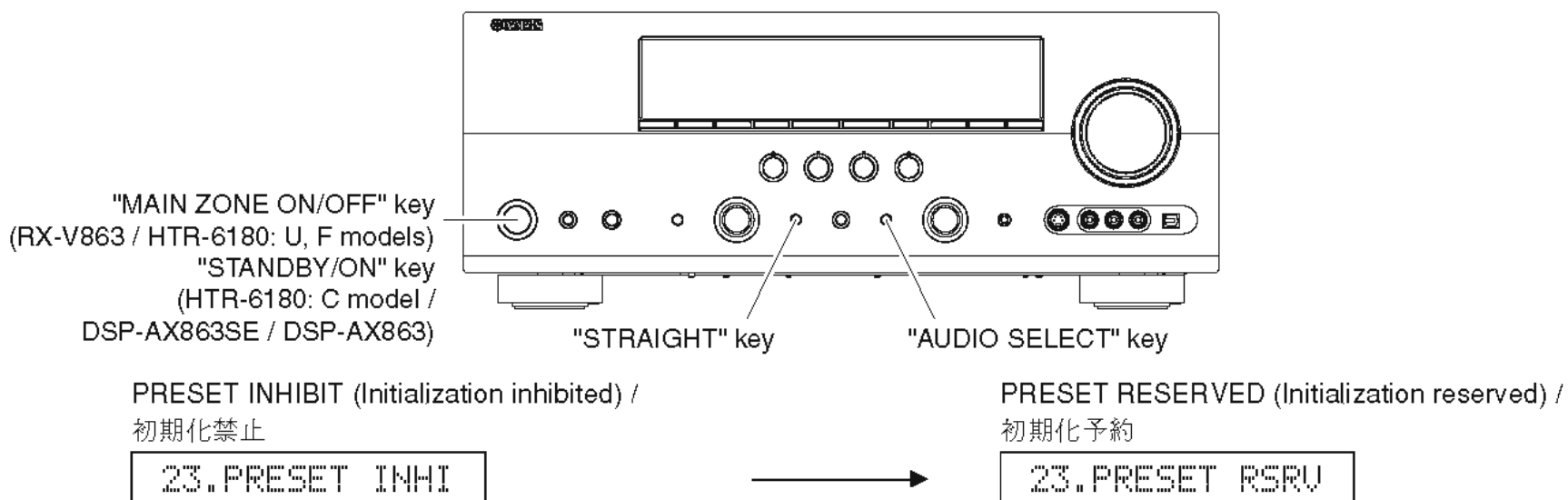

Fig. 4

5. Turn off the power of this unit and disconnect the power cable from the AC outlet.

● Confirmation of firmware version and checksum

To confirm that the firmware is updated successfully, check the firmware version and checksum value by using the self-diagnostic function.

For more information, refer to "SELF-DIAGNOSTIC FUNCTION".

1. Reconnect the power cable of this unit to the AC outlet.
2. Press the "MAIN ZONE ON/OFF" (RX-V863 / HTR-6180: U, F models) / "STANDBY/ON" (HTR-6180: C model / DSP-AX863SE) key while simultaneously pressing the "STRAIGHT" and "AUDIO SELECT" keys. (Fig. 5)

Then the self-diagnostic function is activated.

3. Select the self-diagnostic function menu "24-1. Version".

Confirm the displayed firmware version is the same as the written firmware version. (Fig. 5)

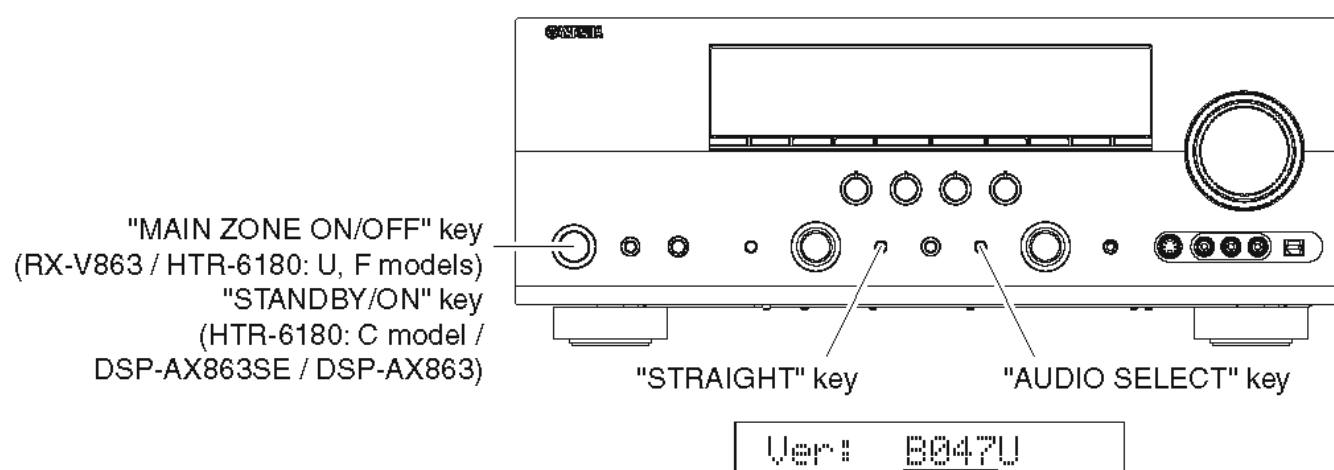

Fig. 5

4. Select the self-diagnostic function menu "24-2. All checksum".
Confirm the displayed checksum is the same as the written firmware checksum. (Fig. 5)
(The checksum value is found where downloading is specified to.)

Sum: 4913

Fig. 6

- * When the displayed firmware version and checksum are different from written firmware version and checksum, follow the steps from 1 to 13 of "Operation Procedures" again.

5. 本機の電源を切り、電源コードをACコンセントから抜きます。

● ファームウェアバージョンおよびチェックサムの確認

ファームウェアが正しく更新されたことを確認するためにファームウェアバージョンおよびチェックサムをダイアグでチェックします。

ダイアグメニューの詳細は「ダイアグ(自己診断機能)」を参照してください。

1. 本機の電源コードをACコンセントに接続します。
2. "STRAIGHT"キーと"AUDIO SELECT"キーを押しながら、"STANDBY/ON"キーを押し、ダイアグを起動します。(Fig. 5)
3. ダイアグ"24-1. Version"を選択します。
表示されたファームウェアのバージョンが書き込んだファームウェアのバージョンと同じであることを確認します。(Fig. 5)





4. ダイアグ"24-2. All checksum"を選択します。
表示されたチェックサムが書き込んだファームウェアのチェックサムと同じであることを確認します。(Fig. 6)
(チェックサム値は指定ダウンロード先に記載されています。)

- ※ 表示されたファームウェアのバージョンおよびチェックサムが、書き込んだファームウェアのバージョンおよびチェックサムと異なる場合、「操作手順」の1から13までをもう一度やり直してください。

Writing method using PC (RS232C)

● **Required Tools**

- Windows 2000/XP, PC with a serial port (RS232C)
- Firmware downloader program
For microprocessor:
 DSP_FLASHER_v3.0_M16C80.exe
For DSP (TI flash ROM):
 DSP_FLASHER Ver2.7.exe
- Firmware
For microprocessor:
 U model:
 U863xxxx.mot
 C, R, T, K, A, B, G, E, F, L models:
 VX63xxxx.mot
For DSP (TI flash ROM):
 Vx63_data1_verxxxxr.hex
- RS232C cross cable "D-sub 9 pin female"
(Specifications)

Pin No.2 RxD		Pin No.2 RxD
Pin No.3 TxD		Pin No.3 TxD
Pin No.5 GND		Pin No.5 GND
Pin No.7 RTS		Pin No.7 RTS
Pin No.8 CTS		Pin No.8 CTS
- RS232C conversion adapter (Including flexible flat cable 9P, 300mm) / Part no.: AAX77610

● **Preparation and precautions before starting the operation**

- Download firmware upgrading program and firmware from the specified source to the same folder of the PC.
- Prepare the above specified RS232C cross cable.
- While writing, keep the other application software on the PC closed.
It is also recommended to keep the software on the task tray closed as well.

● **Operation Procedures**

Writing to the microprocessor





● **Writing firmware**

1. Turn off the power of this unit and disconnect the power cable from the AC outlet.

PC(RS232C)を使用して書き込む方法

● **必要なツール**

- Windows 2000/XP、シリアルポート(RS232C)付きPC
- ファームウェア書き込み用プログラム
マイコン用：
 DSP_FLASHER_v3.0_M16C80.exe
DSP (TI flash ROM)用：
 DSP_FLASHER Ver2.7.exe
- ファームウェア
マイコン用：
 JX63xxxx.mot
DSP (TI flash ROM)用：
 Vx63_data1_verxxxxr.hex
- RS232Cクロスケーブル“D-sub 9pin”メス
(仕様)

Pin No.2 RxD		Pin No.2 RxD
Pin No.3 TxD		Pin No.3 TxD
Pin No.5 GND		Pin No.5 GND
Pin No.7 RTS		Pin No.7 RTS
Pin No.8 CTS		Pin No.8 CTS
- RS232C変換アダプター(カード電線 9P、300mm含む) / 部品番号：AAX77610

● **操作前の準備と注意**

- PCへ指定のダウンロード先からファームウェアアップグレードプログラムおよび、ファームウェアを同じフォルダにダウンロードしてください。
- RS232Cクロスケーブルは必ず上記仕様のものを用意してください。
- 書き込み時は、PC上の他のアプリケーションソフトは閉じてください。
さらに、タスクトレイ上にあるソフトも閉じておくことを推奨します。

● **操作手順**

マイコンへの書き込み

● **ファームウェアの書き込み**

1. 本機の電源を切り、電源コードをACコンセントから抜きます。

2. Set the switch (SW301) of RS232C conversion adapter to the "FLASH UCOM" side. (Fig. 1)
3. Connect the writing port of this unit to the serial port (RS232C) of the PC with RS232C cross cable, RS232C conversion adapter and flexible flat cable as shown below. (Fig. 1)

2. RS232C変換アダプターのスイッチ(SW301)を"FLASH UCOM"側に設定します。(Fig.1)
3. 本機の書き込み用ポートとPCのシリアルポート(RS232C)を下記のように接続します。(Fig. 1)

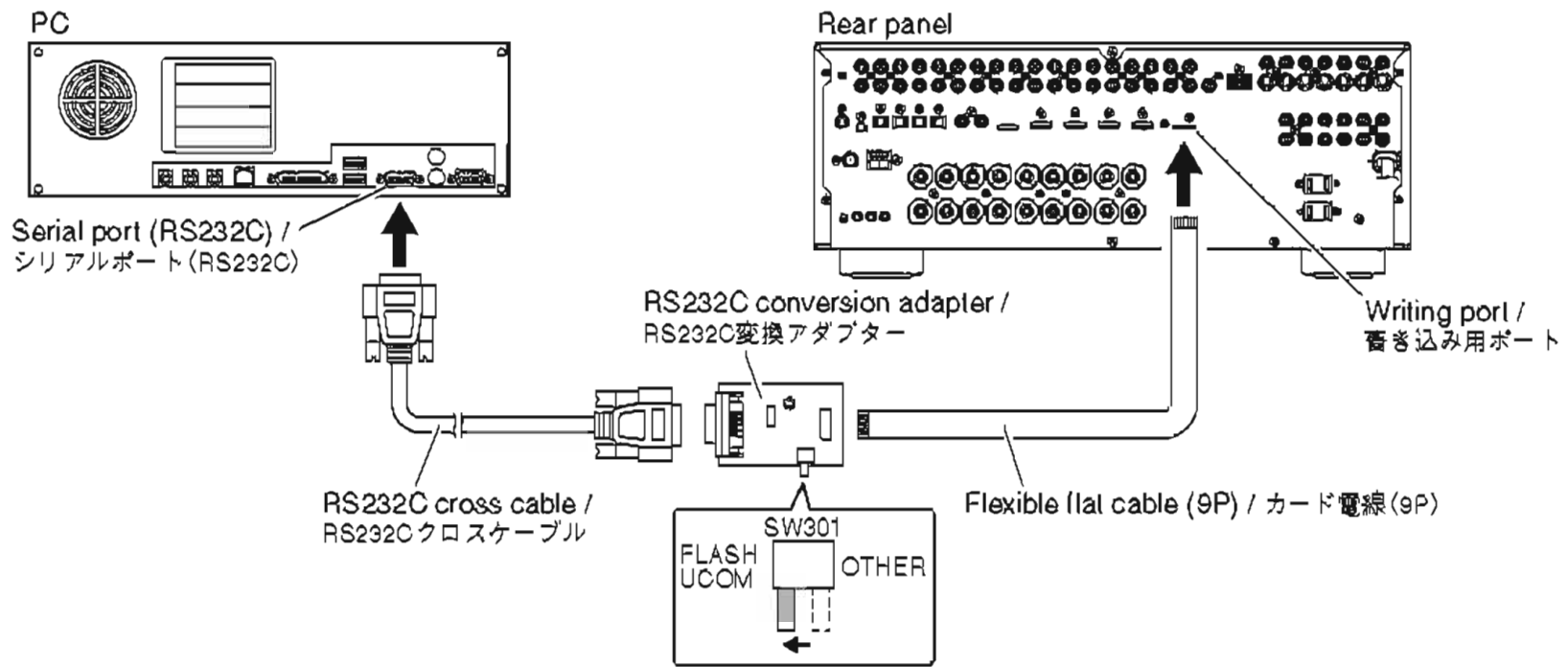

Fig. 1

4. Start up "DSP_FLASHER_v3.0_M16C80.exe". "DSP FLASHER_V3.0" is displayed. (Fig. 2)
5. Click [...]. (Fig. 2)

4. "DSP_FLASHER_v3.0_M16C80.exe"を起動します。"DSP FLASHER_V3.0"が表示されます。(Fig. 2)
5. [...]をクリックします。(Fig. 2)

Select "U863xxxx.mot" (U model) / "VX63xxxx.mot" (C, R, T, K, A, B, G, E, F, L models). (Fig. 2)

"JX63xxxx.mot"を選択します。(Fig. 2)

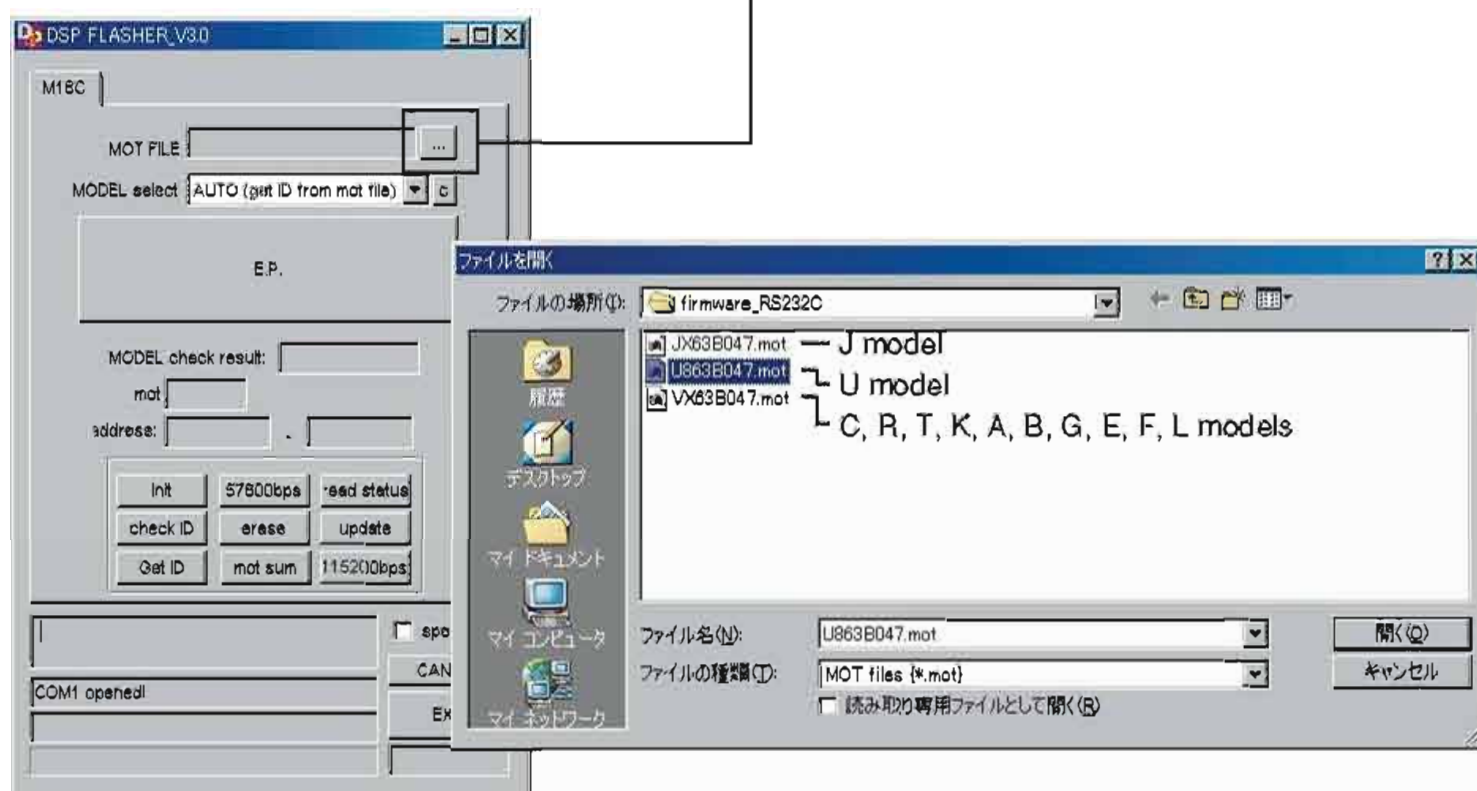

Fig. 2

6. Reconnect the power cable of this unit to the AC outlet.
7. Click [E.P.] to start writing. (Fig. 3)
8. When writing is completed, "Program Finished!" is displayed. (Fig. 3)
Click [OK]. (Fig. 3)
9. Click [EXIT] to end "DSP_FLASHER_v3.0_M16C80.exe". (Fig. 3)

6. 本機の電源コードをACコンセントに接続します。
7. [E.P.]をクリックし、書き込みを開始します。(Fig. 3)
8. 書き込み完了後、“Program Finished!”が表示されます。(Fig. 3)
[OK]をクリックします。(Fig. 3)
9. [EXIT]をクリックし、“DSP_FLASHER_v3.0_M16C80.exe”を終了します。(Fig. 3)

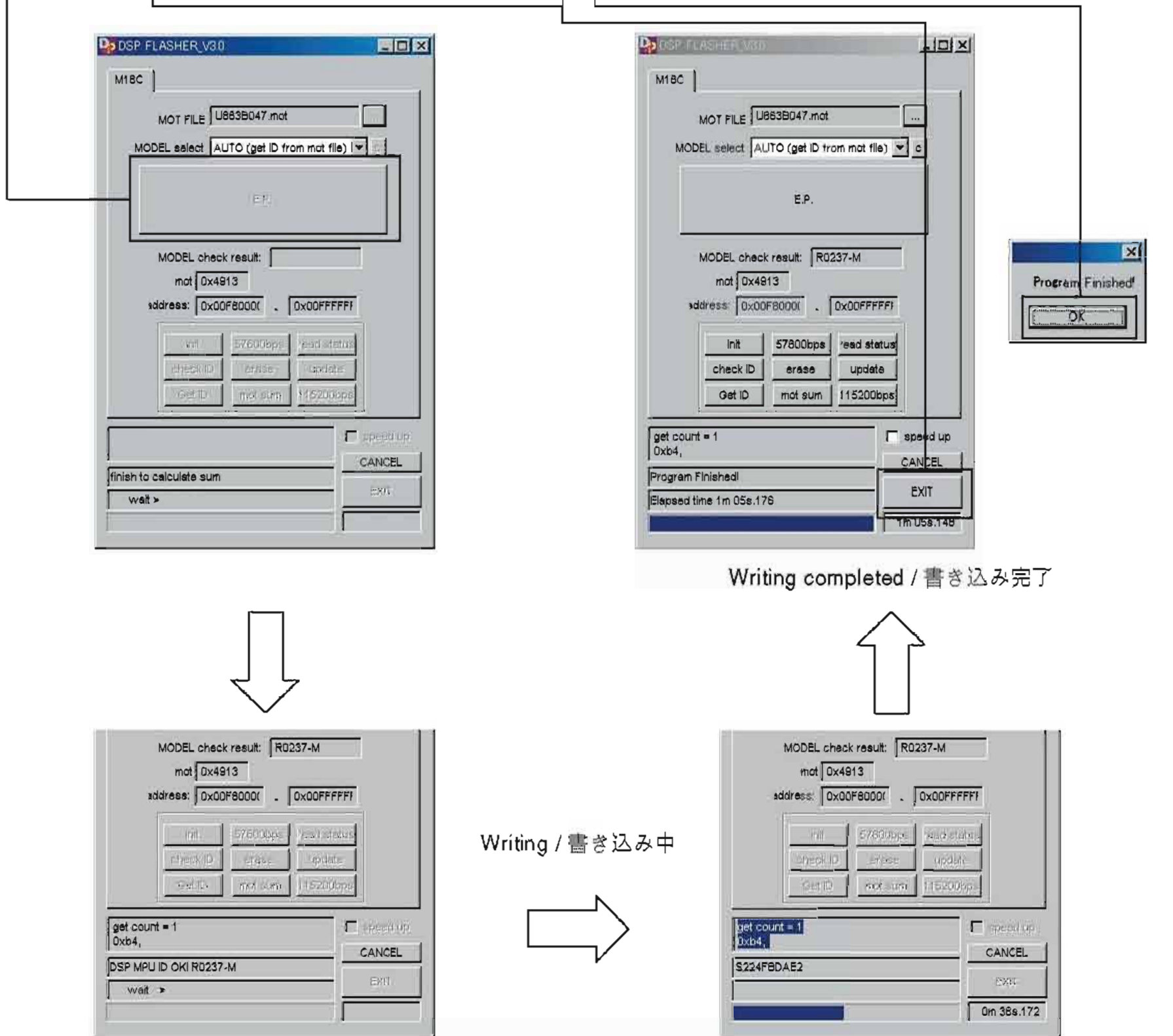

Fig. 3

10. Disconnect the power cable of this unit from the AC outlet.
11. Disconnect the RS232C cross cable, RS232C conversion adapter and flexible flat cable.

- **Initializing of this unit**

- * After updating the firmware, be sure to initialize this unit.
- 1. Connect the power cable of this unit to the AC outlet.
- 2. Press the "MAIN ZONE ON/OFF" (RX-V863 / HTR-6180: U, F models) / "STANDBY/ON" (HTR-6180: C model / DSP-AX863SE) key while simultaneously pressing the "STRAIGHT" and "AUDIO SELECT" keys. (Fig. 4)
Then the self-diagnostic function is activated.
- 3. Select the self-diagnostic function menu "23. FACTORY PRESET".
- 4. Select the "PRESET RSRV".

10. 本機の電源コードをACコンセントから抜きます。
11. RS232Cクロスケーブル、RS232C変換アダプター、カード電線を取り外します。

- **本機の初期化**

- ※ ファームウェアのアップデート後は、必ず本機を初期化してください。
- 1. 本機の電源コードをACコンセントに接続します。
- 2. "STRAIGHT"キーと"AUDIO SELECT"キーを押しながら、"STANDBY/ON"キーを押し、ダイアグを起動します。(Fig. 4)
- 3. ダイアグ"23. FACTORY PRESET"を選択します。
- 4. "PRESET RSRV"を選択します。

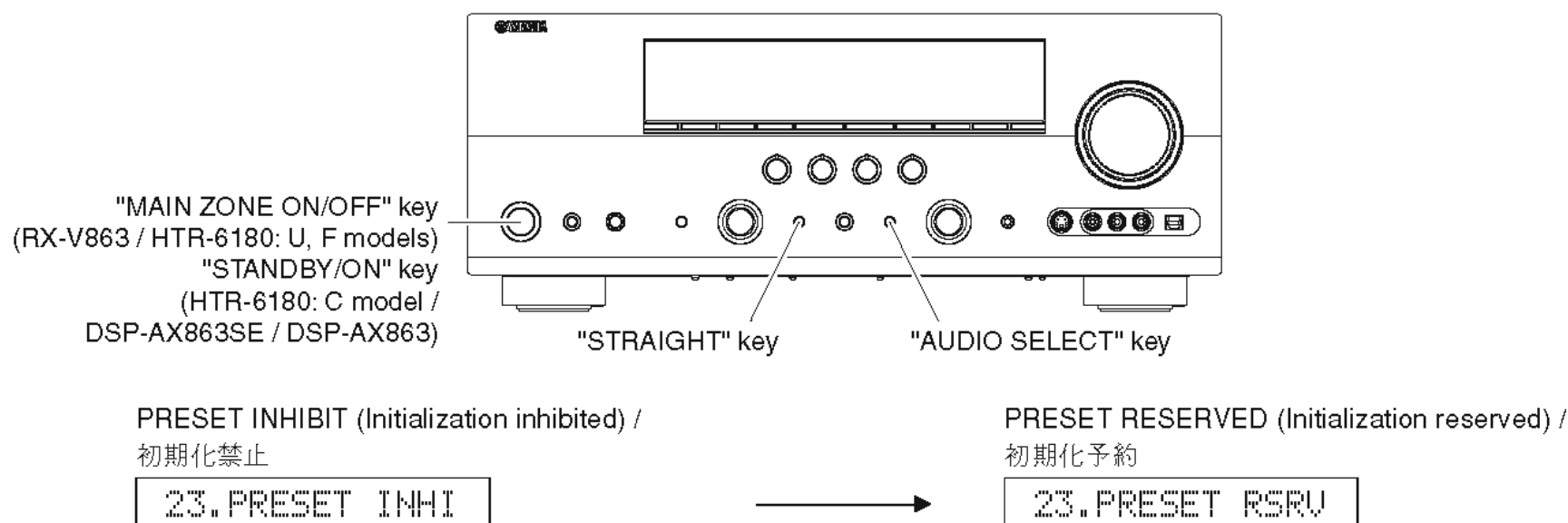

Fig. 4

- **Confirmation of firmware version and checksum**

To confirm that the firmware is updated successfully, check the firmware version and checksum value by using the self-diagnostic function.
For more information, refer to "SELF-DIAGNOSTIC FUNCTION".

- **ファームウェアのバージョンおよびチェックサムの確認**

ファームウェアが正しく更新されたことを確認するためにファームウェアバージョンおよびチェックサムをダイアグでチェックします。
ダイアグメニューの詳細は「ダイアグ(自己診断機能)」を参照してください。

1. Reconnect the power cable of this unit to the AC outlet.
2. Press the "MAIN ZONE ON/OFF" (RX-V863 / HTR-6180: U, F models) / "STANDBY/ON" (HTR-6180: C model / DSP-AX863SE) key while simultaneously pressing the "STRAIGHT" and "AUDIO SELECT" keys. (Fig. 5)
Then the self-diagnostic function is activated.
3. Select the self-diagnostic function menu "24-1. Version".
Confirm the displayed firmware version is the same as the written firmware version. (Fig. 5)

1. 本機の電源コードをACコンセントに接続します。
2. "STRAIGHT"キーと"AUDIO SELECT"キーを押しながら、"STANDBY/ON"キーを押し、ダイアグを起動します。(Fig. 5)
3. ダイアグ"24-1. Version"を選択します。
表示されたファームウェアのバージョンが書き込んだファームウェアのバージョンと同じであることを確認します。(Fig. 5)

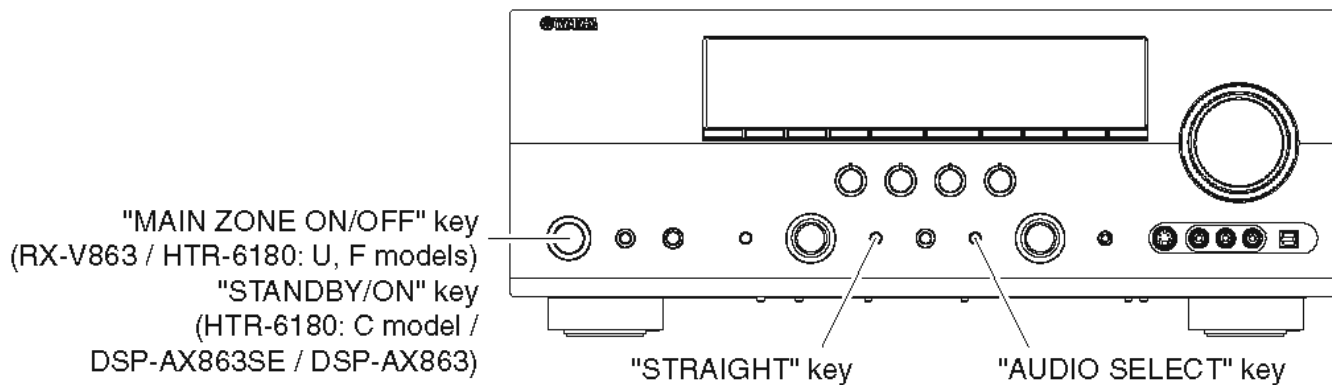

Example / 例 :
U863B047.mot Ver: B047U

Fig. 5

4. Select the self-diagnostic function menu "24-2. All checksum".
Confirm the displayed checksum is the same as the written firmware checksum. (Fig. 5)
(The checksum value is found where downloading is specified to.)

4. ダイアグ"24-2. All checksum"を選択します。
表示されたチェックサムが書き込んだファームウェアのチェックサムと同じであることを確認します。(Fig. 6)
(チェックサム値は指定ダウンロード先に記載されています。)

Example / 例 :
Checksum: 4913 Sum: 4913

Fig. 6

* When the displayed firmware version and checksum are different from written firmware version and checksum, follow the steps from 1 to 11 of "Operation Procedures" again.

※ 表示されたファームウェアのバージョンおよびチェックサムが、書き込んだファームウェアのバージョンおよびチェックサムと異なる場合、“操作手順”の1から11までをもう一度やり直してください。

Writing to DSP

• Writing firmware

1. Turn off the power of this unit and disconnect the power cable from the AC outlet.
2. Set the switch (SW301) of RS232C conversion adapter to the "OTHER" side. (Fig. 1)
3. Connect the writing port of this unit to the serial port (RS232C) of the PC with RS232C cross cable, RS232C conversion adapter and flexible flat cable as shown below. (Fig. 1)

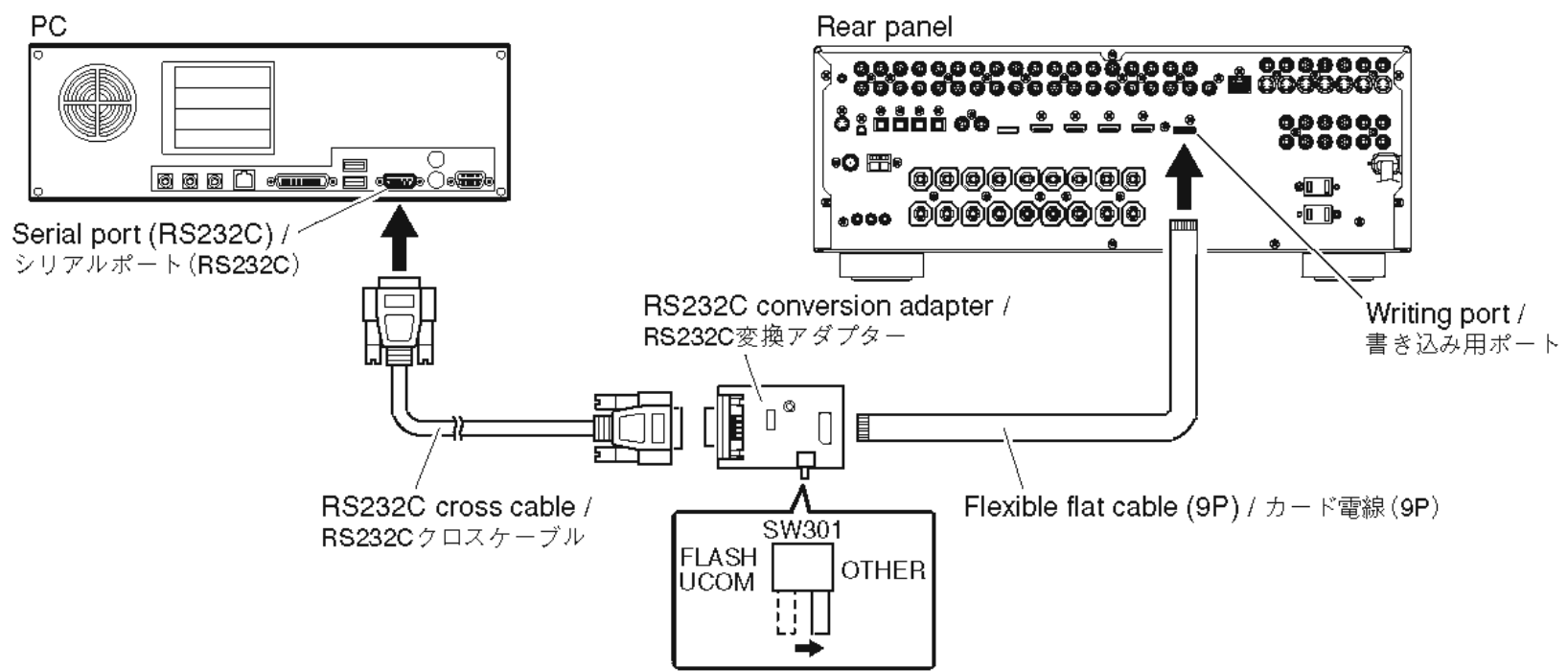

Fig. 1

DSPへの書き込み

• ファームウェアの書き込み

1. 本機の電源を切り、電源コードをACコンセントから抜きます。
2. RS232C変換アダプターのスイッチ(SW301)を“OTHER”側に設定します。(Fig. 1)
3. 本機への書き込み用ポートとPCのシリアルポート(RS232C)を下記のように接続します。(Fig. 1)

4. Start up "DSP_FLASHER Ver2.7.exe".
"DSP_FLASHER_V2.70" is displayed. (Fig. 2)
5. Click [Vx61 DSP]. (Fig. 2)

4. "DSP_FLASHER Ver2.7.exe"を起動します。
"DSP_FLASHER_V2.70"が表示されます。(Fig. 2)
5. [Vx61 DSP]をクリックします。(Fig. 2)

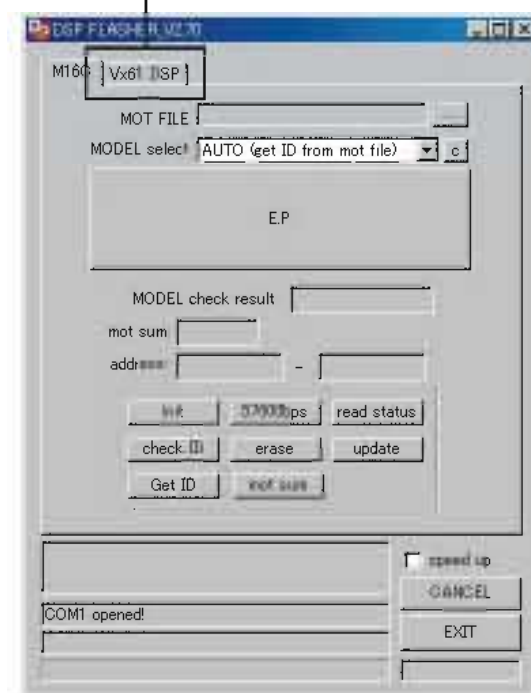

Fig. 2

6. Click [...]. (Fig. 3)

Select "Vx63_data1_verxxxxr.hex". (Fig. 3)

6. [...]をクリックします。(Fig. 3)

"Vx63_data1_verxxxxr.hex"を選択します。(Fig. 3)

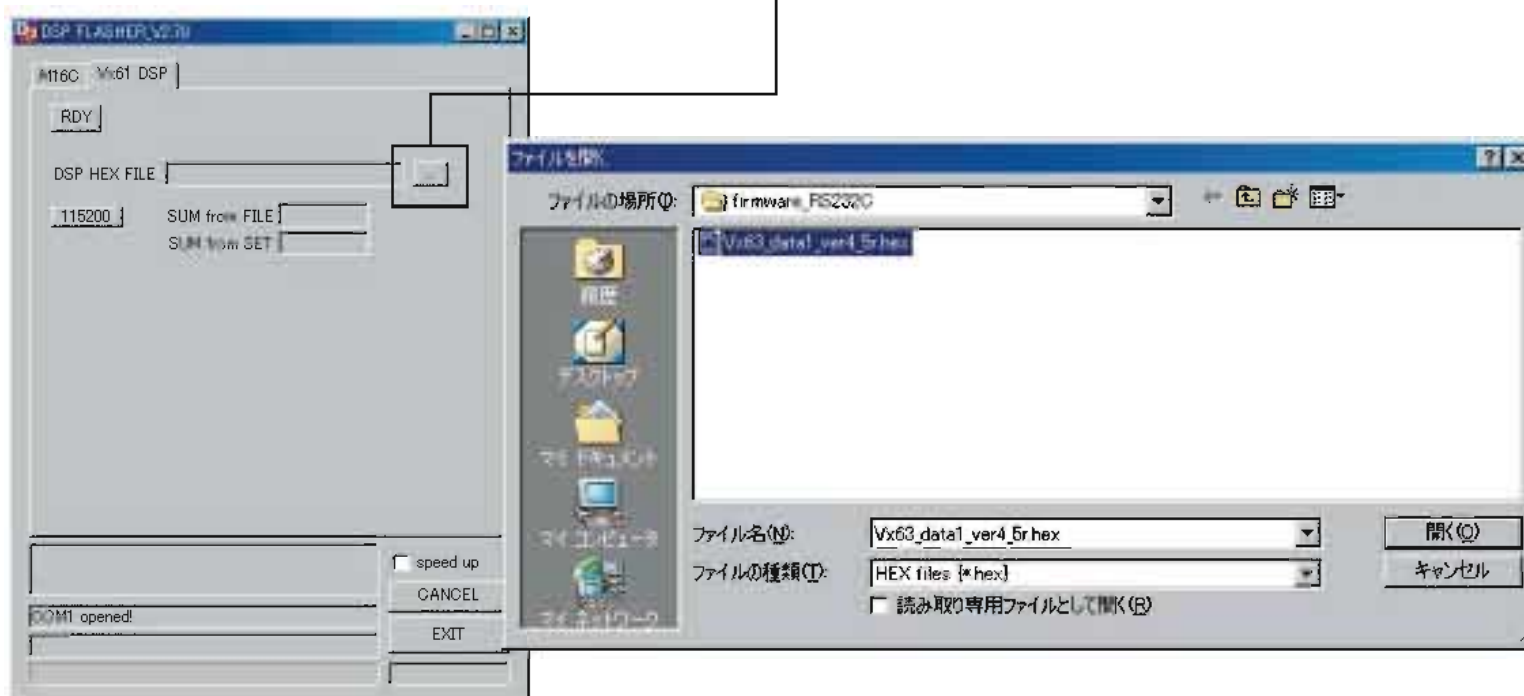

Fig. 3

7. Click [RDY]. (Fig. 4)

7. [RDY]をクリックします。(Fig. 4)

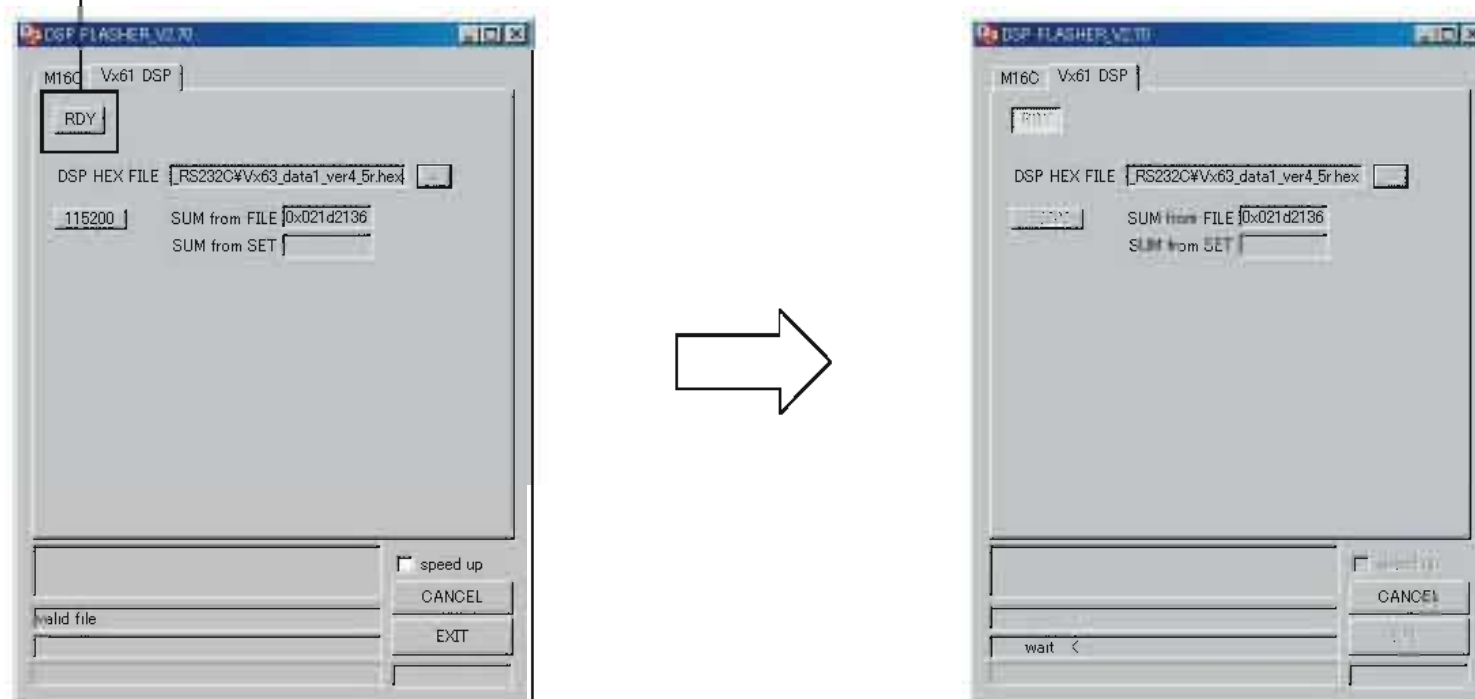
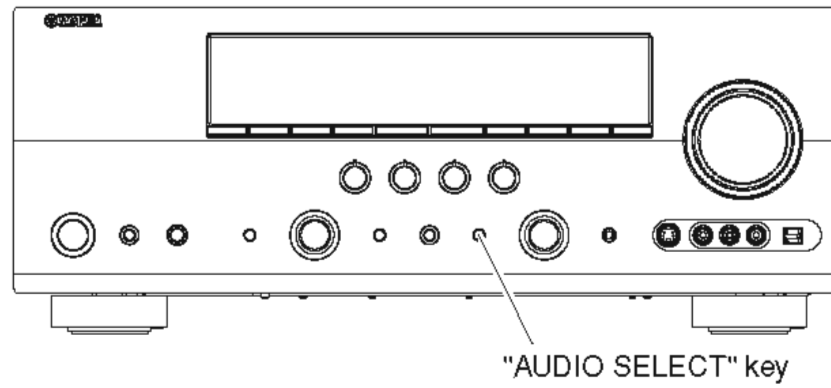

Fig. 4

8. Connect the power cable of this unit to the AC outlet while pressing the "AUDIO SELECT" key. (Fig. 5)
Writing is started automatically. (Fig. 5)

8. 本機の“AUDIO SELECT”キーを押しながら、電源コードをACコンセントに接続します。(Fig. 5)
自動的に書き込みを開始します。(Fig. 5)



Writing / 書き込み中

Fig. 5

9. When writing is completed, "Vx61 DSP Flash finished!" is displayed. (Fig. 6)
10. Click [EXIT] to end "DSP_FLASHER Ver2.7.exe". (Fig. 6)

9. 書き込み完了後、“Vx61 DSP Flash finished!”が表示されます。(Fig. 6)
10. [EXIT]をクリックし、“DSP_FLASHER Ver2.7.exe”を終了します。(Fig. 6)

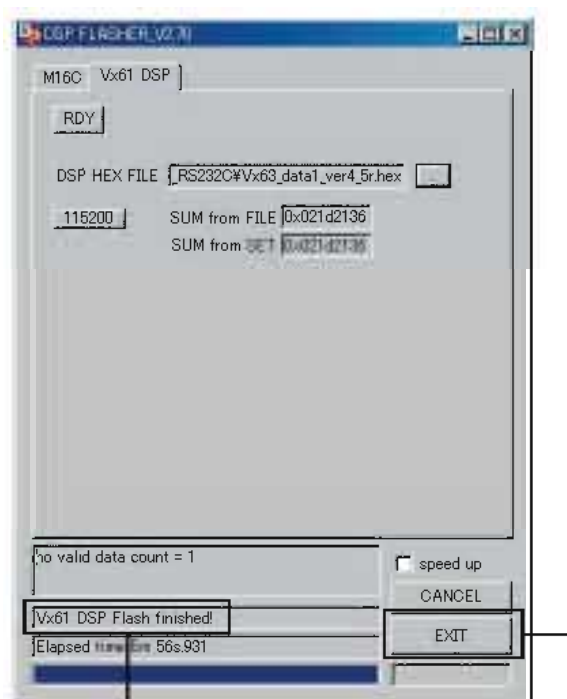

When writing is completed, "Vx61 DSP Flash finished!" is displayed.
書き込み完了後、“Vx61 DSP Flash finished!”が表示されます。

Fig. 6

11. Disconnect the power cable of this unit from the AC outlet.
12. Disconnect the RS232C cross cable, RS232C conversion adapter and flexible flat cable.

11. 本機の電源コードをACコンセントから抜きます。
12. RS232Cクロスケーブル、RS232C変換アダプター、カード電線を取り外します。

- **Initializing of the main unit**

* After updating the firmware, be sure to initialize this unit.

1. Connect the power cable of this unit to the AC outlet.
2. Press the "MAIN ZONE ON/OFF" (RX-V863 / HTR-6180: U, F models) / "STANDBY/ON" (HTR-6180: C model / DSP-AX863SE) key while simultaneously pressing the "STRAIGHT" and "AUDIO SELECT" keys. (Fig. 7)
Then the self-diagnostic function is activated.
3. Select the self-diagnostic function menu "23. FACTORY PRESET".
4. Select the "PRESET RSRV".

- **本機の初期化**

※ ファームウェアのアップデート後は、必ず本機を初期化してください。

1. 本機の電源コードをACコンセントに接続します。
2. "STRAIGHT"キーと"AUDIO SELECT"キーを押しながら、"STANDBY/ON"キーを押し、ダイアグを起動します。(Fig. 7)
3. ダイアグ"23. FACTORY PRESET"を選択します。
4. "PRESET RSRV"を選択します。

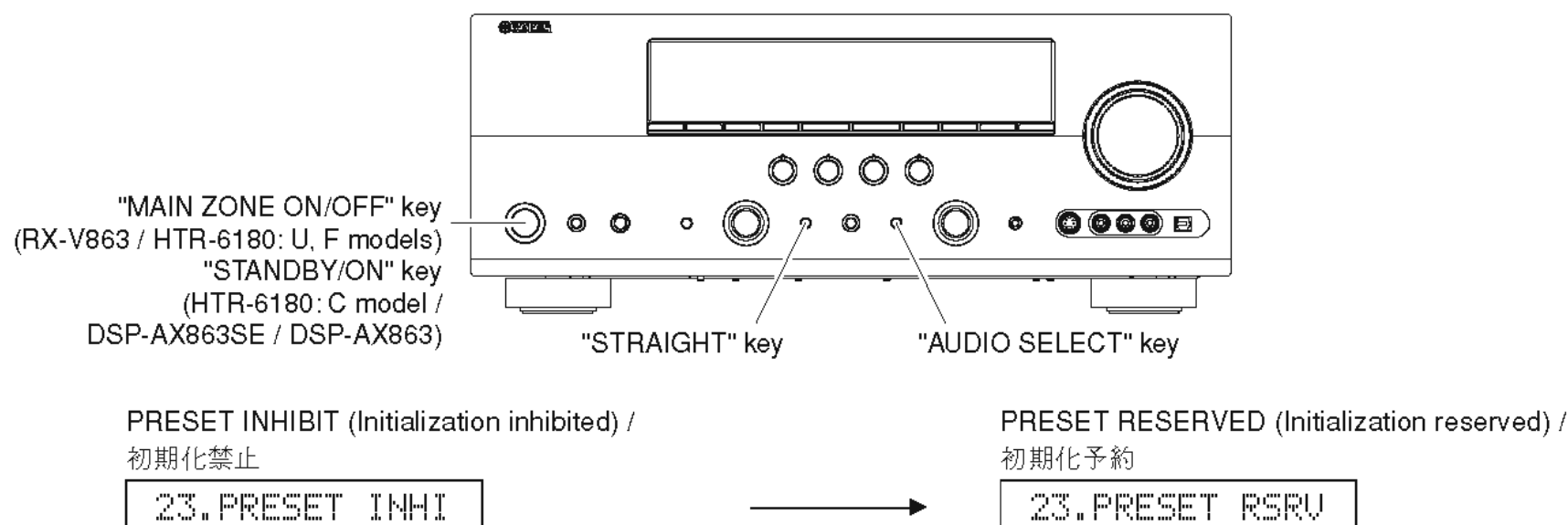

Fig. 7

- **Confirmation of firmware version and checksum**

To confirm that the firmware is updated successfully, check the firmware version and checksum value by using the self-diagnostic function.
For more information, refer to "SELF-DIAGNOSTIC FUNCTION".

- **ファームウェアのバージョンおよびチェックサムの確認**

ファームウェアが正しく更新されたことを確認するためにファームウェアバージョンおよびチェックサムをダイアグでチェックします。
ダイアグメニューの詳細は「ダイアグ(自己診断機能)」を参照してください。

1. Connect the power cable of this unit to the AC outlet.
2. Press the "MAIN ZONE ON/OFF" (RX-V863 / HTR-6180: U, F models) / "STANDBY/ON" (HTR-6180: C model / DSP-AX863SE) key while simultaneously pressing the "STRAIGHT" and "AUDIO SELECT" keys. (Fig. 8)
Then the self-diagnostic function is activated.
3. Select the self-diagnostic function menu "24-3. TI FLASH version".
Confirm the displayed firmware version is the same as the written firmware version. (Fig. 8)

1. 本機の電源コードをACコンセントに接続します。
2. "STRAIGHT"キーと"AUDIO SELECT"キーを押しながら、"STANDBY/ON"キーを押し、ダイアグを起動します。(Fig. 8)
3. ダイアグ"24-3. TI FLASH version"を選択します。
表示されたファームウェアのバージョンが書き込んだファームウェアのバージョンと同じであることを確認します。(Fig. 8)

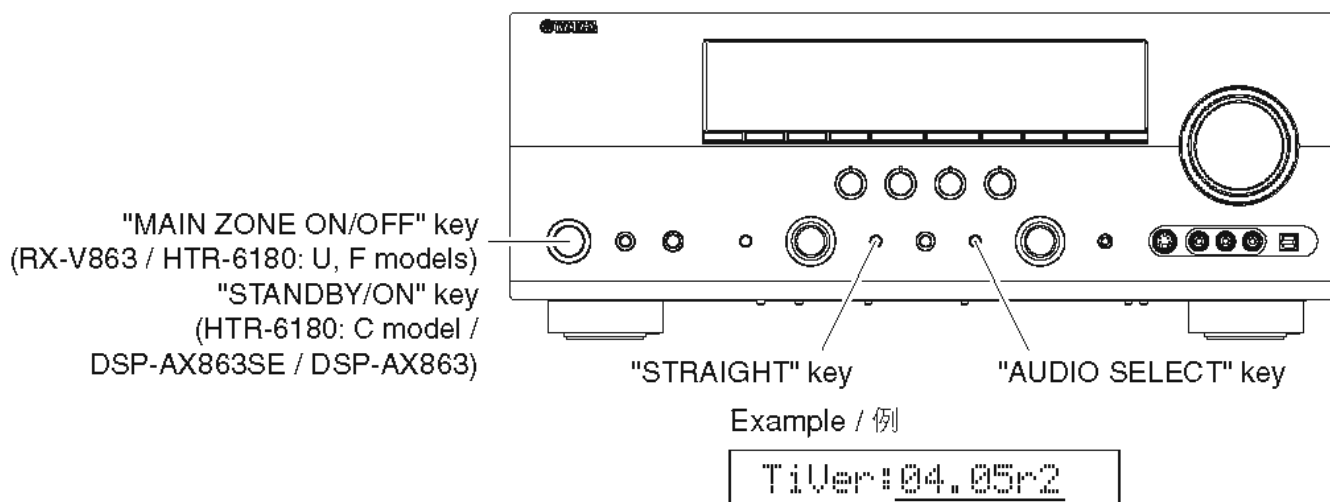

Fig. 8

4. Select the self-diagnostic function menu "24-4. TI FLASH checksum".
Confirm the displayed checksum is the same as the written firmware checksum. (Fig. 9)
(The checksum value is found where downloading is specified to.)

4. ダイアグ"24-4. TI FLASH checksum"を選択します。
表示されたチェックサムが書き込んだファームウェアのチェックサムと同じであることを確認します。(Fig. 9)
(チェックサム値は指定ダウンロード先に記載されています。)

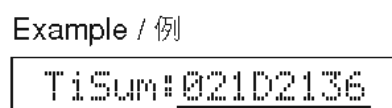

Fig. 9

* When the displayed firmware version and checksum are different from written firmware version and checksum, follow the steps from 1 to 12 of "Operation Procedures" again.

※ 表示されたファームウェアのバージョンおよびチェックサムが、書き込んだファームウェアのバージョンおよびチェックサムと異なる場合、「操作手順」の1から12までをもう一度やり直してください。

SELF-DIAGNOSTIC FUNCTION / ダイアグ (自己診断機能)

This unit has self diagnosis functions that are intended for inspection, measurement and location of faulty point. There are 24 main menu items, each of which has sub-menu items. Listed in the table below are menu items and sub-menu items. Note that not all menu items listed will apply to the models covered in this service manual.

本機には、検査、測定、不良個所の発見を目的にしたダイアグ (自己診断機能) があります。ダイアグメニューは24個あり、それぞれにサブメニューがあります。下表はダイアグメニュー一覧です。下表の全ダイアグメニュー項目が、このサービスマニュアル記載のモデルに適用されるとは限りません。

No.	Main menu	Sub-menu
1	BYPASS	1. ANALOG BYPASS 2. DSP BYPASS
2	RAM THRR	1. RAM MARGIN 2. RAM FULL BIT
3	HDMI AUDIO	1. SPDIF 2. Multi 3. DSD
4	SPEAKERS SET	1. FRONT : SML 0dB 2. CENTER : NONE 3. LFEB : FRONT 4. PRESENCE Mix-P 5. PRESENCE Mix-F 6. Zone2 Amp ON 7. Bi-AMP 8. TONE : MAX 9. TONE : MIN
5	XCH-INPUT	1. 6ch INPUT 6ohms 2. 8ch INPUT 6ohms 3. 6ch INPUT 8ohms 4. 8ch INPUT 8ohms 5. LIMIT
6	MIC CHECK	1. MIC CHECK
7	FLU/OSD CHECK	1. VFD CHECK 2. VFD DISP OFF / MONITOR MUTE 3. VFD DISP ALL / Component MUTE 4. VFD DIMMER / OSD CHARACTERS PATTERN 5. CHECK PATTERN / OSD CHARACTERS PATTERN
8	MANUAL TEST	1. TEST ALL
9	A/D DATA CHECK	1. PST1, PS2 2. DC, TH 3. IMP, PL 4. DST, DK 5. KO, K1
10	VIDEO CHECK	1. I2C : XXXXXXXX 2. DIGITAL COMPONENT 3. DIGITAL CVBS 4. DIGITAL Y/C 5. ANALOG BYPASS 6. TEST PATTERN 7. VIDEO INFORMATION
11	XM STATUS (U, C models)	1. 1k -1dB/44kHz 2. 1k -61dB/44kHz 3. MUTE/44kHz 4. XM TONE/44kHz 5. ISO TONE/44kHz 6. 1k -1dB/32kHz 7. 1k -61dB/32kHz 8. MUTE/32kHz 9. XM TONE/32kHz 10. ISO TONE/32kHz 11. BUS POWER : OFF

No.	Main menu	Sub-menu
12	SIRIUS (U, C models)	1. SIRIUS : OK (NG) 2. SR : XX XX XX 3. SSP : (SIRIUS #0 version) 4. MAC : (SIRIUS #1 version) 5. ADP : (SIRIUS #2 version) 6. PRDID : (Product ID) 7. SEQID : (Sequence ID)
13	HD RADIO (U model)	1. HD CPU V : XXXXX 2. D : XXXXX
14	DOCK	1. DOCK : XXXXX 2. BT V : -----
15	HDMI INFORMATION	1. MN : XXXXXXXX 2. PI : 312X 3. VN : YAMAMA 1. HDMI NONE 2. HDMI IN 1 3. HDMI IN 2 4. HDMI IN 3 5. HDMI UPCONV. 6. HDMI UP THR
16	HDMI SELECT	1. DSP STATUS (5 Byte) 1. TI BUS :
17	IF STATUS	1. TI BUS :
18	DSP BUS CHECK	1. TI BUS :
19	RESERVED	
20	PROTECTION HISTORY	1. HISTORY 1 2. HISTORY 2 3. HISTORY 3 4. HISTORY 4
21	RESERVED	
22	UPDATE (Not applied to these models / このモデルには適用されません。)	1. TI FLASH BOOT 2. CEC UPDATE
23	FACTORY PRESET	1. PRESET INHI 2. PRESET RSRV 1. VERSION DISP 2. SUM ALL / PROGRAM 3. TI FLASH VERSION (1 Byte) 4. TI FLASH SUM (4 Byte) 5. CEC VERSION 6. XM VERSION (U, C models) 7. SIRIUS VERSION (U, C models) 8. XX XXX X XXX
24	ROM VER./SUM/PORT	

● **Starting Self-Diagnostic Function**

Press the "MAIN ZONE ON/OFF" (RX-V863 / HTR-6180: U, F models) / "STANDBY/ON" (HTR-6180: C model / DSP-AX863SE / DSP-AX863) key while simultaneously pressing those two keys of this unit as indicated in the figure below.

Keys of this unit / 本機キー

RX-V863 / HTR-6180 (U, F models)



HTR-6180 (C model) / DSP-AX863SE / DSP-AX863



● **ダイアグの起動**

本機の下図に示すキーを同時に押しながら“STANDBY/ON”キーを押すと、ダイアグが起動します。

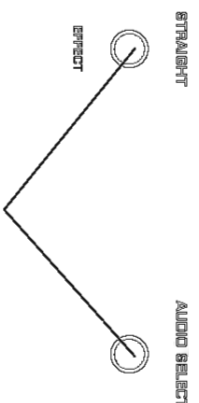

Turn on the power while pressing these keys. / これらのキーを同時に押しながら、電源オンする。

● **Starting Self-Diagnostic Function in the protection cancel mode**

If the protection function works and causes hindrance to trouble diagnosis, cancel the protection function as described below, and it will be possible to enter the self-diagnostic function mode. (The protection functions other than the excess current detect function will be disabled.)

Press the "MAIN ZONE ON/OFF" (RX-V863 / HTR-6180: U, F models) / "STANDBY/ON" (HTR-6180: C model / DSP-AX863SE / DSP-AX863) key while simultaneously pressing those two keys indicated in the figure above. At this time, keep pressing those two keys for 3 seconds or longer.

In this mode, the [SLEEP] segment of the FL display of this unit flashes to indicate that the mode is self-diagnostic function mode with the protection functions disabled.

● **プロテクション解除モードでの起動**

プロテクションが動作することにより、故障箇所の診断に支障をきたすような場合は、次の方法によりプロテクションを解除した状態でダイアグモードに入ることができます。(過電流検出以外のプロテクション動作を解除する)

上図のキーを同時に押しながら“STANDBY/ON”キーを押します。このとき、上図のキーを3秒以上押し続けてください。
このモードでは本機FLの[SLEEP]セグメントが点滅し、プロテクションを解除した状態でのダイアグモードであることを知らせます。

● **Canceling Self-Diagnostic Function**

1. Before canceling self-diagnostic function, execute setting for FACTORY PRESET of main menu No. 23 (Memory initialization inhibited or Memory initialized).
* In order to keep the user memory stored, be sure to select PRESET INHIBITED (Memory initialization inhibited).
2. Turn off the power by pressing the "MAIN ZONE ON/OFF" (RX-V863 / HTR-6180: U, F models) / "STANDBY/ON" (HTR-6180: C model / DSP-AX863SE / DSP-AX863) key of this unit.

● **ダイアグの解除**

1. ダイアグを解除する前に、ダイアグメニューNo. 23 FACTORY PRESET (メモリーの初期化禁止/またはメモリーの初期化)の設定をします。
※ ユーザーメモリーを保持したい場合は、必ず PRESET INHIBITED (メモリー初期化禁止)を選択してください。
2. 本機の“STANDBY/ON”キーを押し、電源オフします。

● **Display provided when Self-Diagnostic Function started**

On the FL display of this unit, an opening message (including the version and the protection history) appears for a few seconds followed by the main menu display (1. ANALOG BYPASS).

● **ダイアグ起動時の表示**

本機のFLディスプレイには、オーディング(プロテクション履歴/バージョン)が表示され、数秒後にメニューメニュー表示(1. ANALOG BYPASS)となります。

● **When there is no history of protection function:**

Opening message / オーディング表示

プロテクション履歴が無い場合: Main menu display / メニュー表示

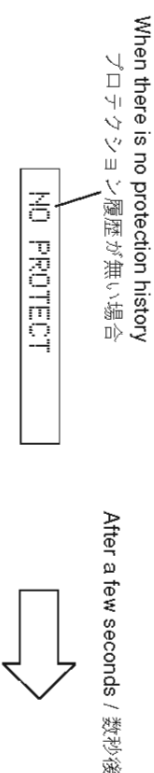

CAUTION!

Using this product with the protection function disabled may cause damage to this unit. Use special care for this point when using this mode.

注意!

プロテクション解除モードでの起動は、危険な状態でもプロテクションが作動しないため、動作させると本機を破壊することがあります。
このモードを使用する場合は十分注意してください。

**When there is a history of protection function:
When there is a history of protection function due
to excess current**

プロテクション履歴がある場合：
過電流によるプロテクション履歴がある場合

I PROTECT

Cause: An excessive current flowed through the power amplifier.

Supplementary information:

As current of the power amplifier is detected, the abnormal channel can be identified by checking the current detect transistor.

Turning on the power without correcting the abnormality will cause the protection function to work immediately and the power supply will instantly be shut off.

原因: パワーアンプに過電流が流れた。

補足: パワーアンプの電流を検出していますので、電流検出トランジスタをチェックすれば異常チャンネルが特定できます。
異常状態のまま電源オンすると、瞬時にプロテクションがかかり、すぐに電源が切れます。

Note)

- Applying the power to this unit without correcting the abnormality can be dangerous and cause additional circuit damage. To avoid this, if protection function has been activated 3 times continuously, the power will not turn on even when the "MASTER ON/OFF" (RX-V863 / HTR-6180: F model) / "STANDBY/ON" (HTR-6180: U, C models / DSP-AX863SE) key is pressed. In order to turn on the power again, disconnect the power cable of this unit from the AC outlet once and then reconnect it again.
- The output transistors in each power amplifier should be checked for damage before applying power to this unit.
- Power amplifier current should be monitored by measuring DC voltage across the emitter resistors for each channel.

注意！

- 異常状態のまま本機の電源を入れると、危険な状態になり、さらに回路が損傷を受ける原因になります。そのため連続してプロテクションが働いた場合、3回目から"STANDBY/ON"キーを押しても電源が入らなくなります。再度電源を入れる場合、一度本機の電源コードをAC電源コンセントから抜いて接続し直してください。
- 本機の電源をいれる前に、各パワーアンプの出力トランジスタに損傷がないかチェックしてください。
- パワーアンプの電流は、各チャンネルのエミッターの抵抗器間DC電圧を測定することによりモニターしてください。

**When there is a history of protection function due
to abnormal DC output**

DC出力異常によるプロテクション履歴がある場合

DC PRT :xxx G

Cause: DC output of the power amplifier is abnormal.

Supplementary information:

The protection function worked due to a DC voltage appearing at the speaker terminal.

A cause could be a defect in the amplifier.

If the power is turned on with the abnormality unsolved, the protection function works in 3 seconds to turn off the power.

原因: パワーアンプのDC出力が異常。

補足: アンプの故障でスピーカー端子に直流電圧が掛かるなどが原因で、プロテクションが働いたことを示します。
異常状態のままパワーオンすると、3秒後にプロテクションが掛かり、電源が切れます。

When there is a history of protection function due to abnormal voltage in the power supply section

PS1 PRT:xxx

 or PS2 PRT:xxx

Cause: The voltage in the power supply section is abnormal.

Supplementary information:
The protection function worked due to a defect or overload in the power supply.
If the power is turned on with the abnormality unsolved, the protection function works in 1 second to turn off the power.

電源部の電圧異常によるプロテクション履歴がある場合

原因: 電源部の電圧が異常。
補足: 電源電圧による原因で、プロテクションが働いたことを示します。
異常状態のままパワーオンすると、1秒後にプロテクションが掛かり、電源が切れます。

When there is a history of protection function due to excessive heat sink temperature

TMP PRT:xxx G

Cause: The temperature of the heat sink is excessive.

Supplementary information:
The protection function worked due to the temperature limit being exceeded.
Causes could be poor ventilation or a defect related to the thermal sensor.

ヒートシンクの異常温度によるプロテクション履歴がある場合

原因: ヒートシンクの温度が異常。
補足: 温度制限を越えた原因で、プロテクションが働いたことを示します。

If the power is turned on with the abnormality unsolved, the protection function works in 1 second to turn off the power.

異常状態のままパワーオンすると、1秒後にプロテクションが掛かり、電源が切れます。

For detection of each protection function, refer to main menu described later.

各プロテクションの検出に関しては、後述のメインメニューを参照してください。

History of protection function

When the protection function has worked, its history is stored in memory with a backup.

Even if no abnormality is noted while servicing this unit, an abnormality which has occurred previously can be defined as long as the backup data has been stored.

The history of the protection function is cleared when self-diagnostic function is cancelled by selecting PRESET RESERVED (Memory initialized) of main menu No. 23 or when the backup data is erased.

プロテクションの履歴

プロテクションが働いた場合、履歴をバックアップして記憶しています。

サービスのときに異常が認められなくても、バックアップが残っていれば、お客様のところで起きた異常を区別できます。

メインメニューNo. 23 PRESET RESERVED(メモリーの初期化)を選んでダイアグを解除した場合、またはバックアップが消えた場合にプロテクションの履歴はクリアされます。

● **Display during menu operation**

The function at work is indicated on the FL indicator of this unit.

The contents displayed during the function operation are described later in the "Details of self-diagnostic function menu" section.

● **メニュー動作中の表示**

本機のFLディスプレイには動作中の機能が表示されます。

機能動作中の表示内容については、後述の機能詳細で記述します。

● Operation procedure of Main menu and Sub-menu

There are 24 main menu items, each them having sub-menu items.

Main menu selection:

Select the main menu using "PROGRAM" knob.

Sub-menu selection:

Select the sub-menu using "SCENE 2" (forward) / "SCENE 1" (reverse) keys or "PRESET/TUNING >" (forward) / "PRESET/TUNING <" (reverse) keys (U, C, R, T, K, A, G, E, F, L models).

● メインメニューとサブメニューの操作

ダイアグにはNo. 1~24のメインメニューがあり、そのそれぞれにサブメニューがあります。

メインメニューの選択:

"PROGRAM"ツマミで選択します。

サブメニューの選択:

"SCENE 2"(順送り)、"SCENE 1"(逆送り)キーまたは"PRESET/TUNING >"(順送り)、"PRESET/TUNING <"(逆送り)キーで選択します。

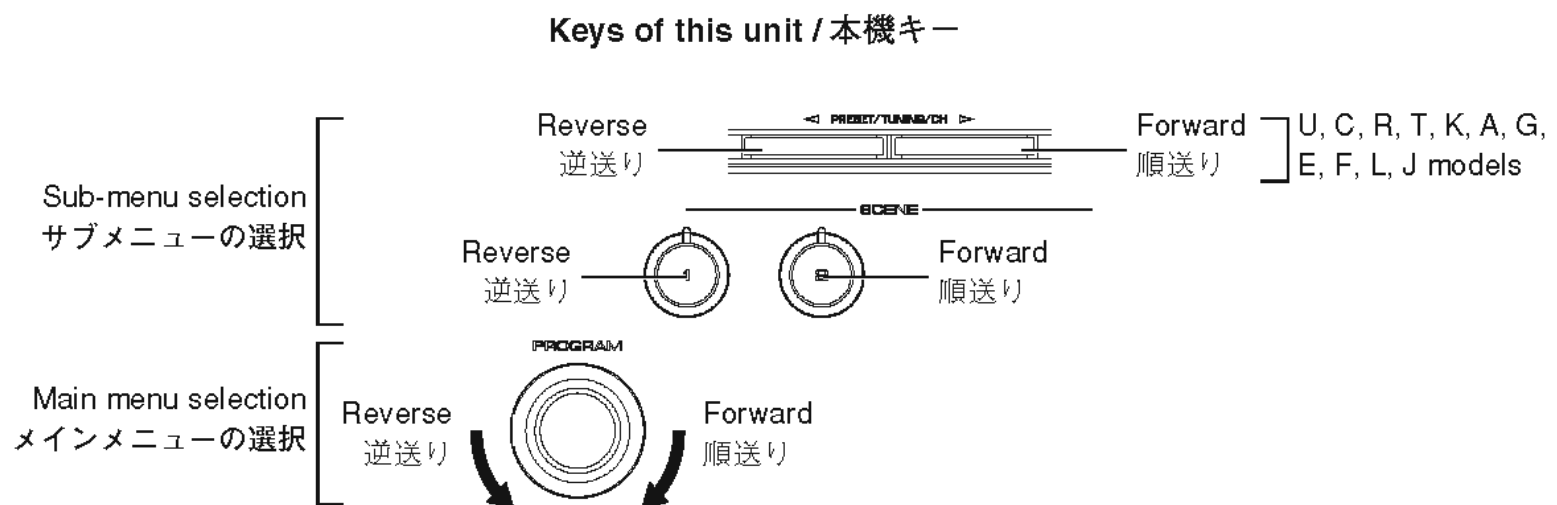

● Functions in Self-Diagnostic Function mode

In addition to the self-diagnostic function menu items, functions as listed below are available.

- Power on/off
- Master volume
- Muting
- Speaker relay control of A and B
- Input selection
- Audio select
- Tone control
- * Functions related to the tuner and the set menu are not available.

● ダイアグ中の機能

ダイアグメニューの他に、以下の機能が動作します。

- パワーオン/オフ
- マスターボリューム
- ミューティング
- スピーカーリレーA、B
- インプットセレクト
- オーディオセレクト
- トーンコントロール

※ チューナー関連、セットメニュー関連は機能しません。

● Initial settings when starting Self-Diagnostic Function

The following are initial settings when starting self-diagnostic function.

- Master volume: -20 dB
- Input: DVD (MULTI CHANNEL INPUT OFF)
- Effect level: 0 dB
- Main menu: 1. ANALOG BYPASS

When self-diagnostic function is canceled, these settings are restored to those before starting self-diagnostic function.

● ダイアグ開始時の初期設定

ダイアグ開始時に以下のような設定になります。

- マスターボリューム: -20 dB
- インプット: DVD (マルチチャンネルINPUT オフ)
- エフェクトレベル: 0 dB
- メインメニュー: 1. ANALOG BYPASS

ダイアグ解除時にはダイアグ開始前の状態に戻ります。

● **Details of Self-Diagnostic Function menu**

1. BYPASS

Using the sub-menu, it is possible to select ANALOG BYPASS output or DSP BYPASS output.

ANALOG BYPASS

The analog input audio signal is output to FRONT L/R by PURE DIRECT.

1. ANALOG BYPASS

INPUT: DVD ANALOG
SPEAKER OUT: 1 kHz, SUBWOOFER OUTPUT: 50 Hz

Input level	Volume	SPEAKER OUT				SUBWOOFER OUTPUT
		FRONT L/R	CENTER	SURROUND L/R	SURROUND BACK L/R	
Both ch, -20 dBm	+6.0 dB	+12.0 dBm	-∞	-∞	-∞	-∞

DSP BYPASS

The digital input audio signal is output to FRONT L/R by PURE DIRECT.

1. DSP BYPASS

INPUT: DVD ANALOG
SPEAKER OUT: 1 kHz, SUBWOOFER OUTPUT: 50 Hz

Input level	Volume	SPEAKER OUT				SUBWOOFER OUTPUT
		FRONT L/R	CENTER	SURROUND L/R	SURROUND BACK L/R	
Both ch, -20 dBm	+6.0 dB	+12.0 dBm	-∞	-∞	-∞	-∞

● **ダイアグメニュー詳細**

1. BYPASS

サブメニュー操作によりANALOG BYPASS/DSP BYPASSが選択可能です。

ANALOG BYPASS

アナログ入力の音声信号をPURE DIRECTでFRONT L/Rへ出力します。

DSP BYPASS

デジタル入力の音声信号をPURE DIRECTでFRONT L/Rへ出力します。

ANALOG BYPASS

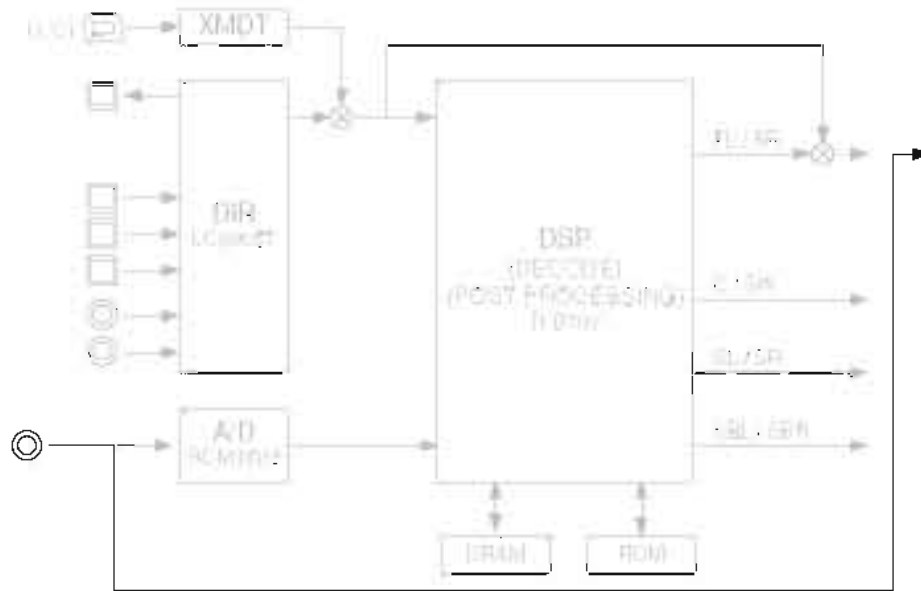

(Shaded items not used in this example)

DSP BYPASS

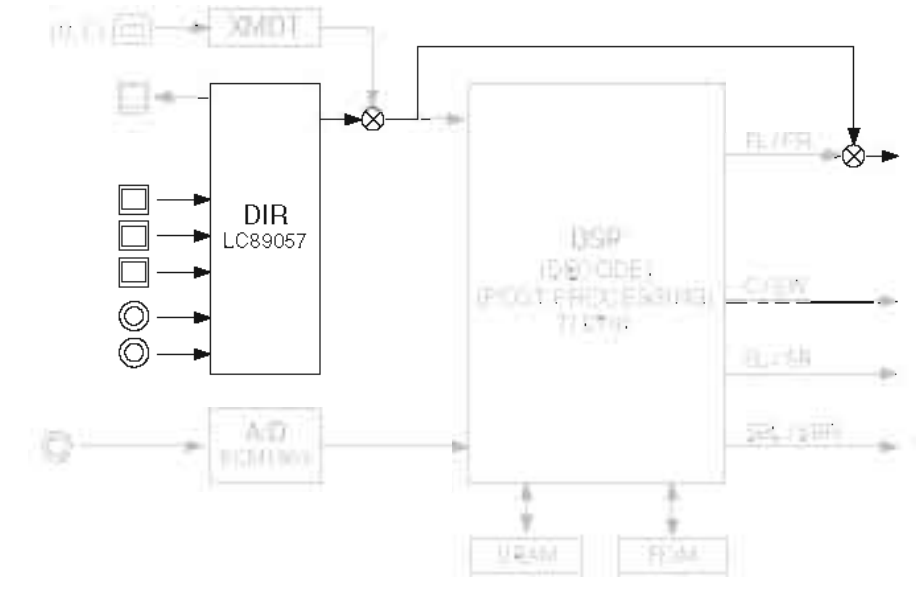

(Shaded items not used in this example)

2. RAM THROUGH

Using the sub-menu, it is possible to select MARGIN output or FULL BIT output.

RAM MARGIN

The signal is output including the head margin.

2. RAM THROUGH

サブメニュー操作によりMARGIN/FULL BITが選択可能です。

RAM MARGIN

ヘッドマージンを含んで出力されます。

2. RAM MARGIN

FRONT L/R	CENTER	SURROUND L/R	SURROUND BACK L/R	SUBWOOFER
+9.0 dB	+13.5 dB	+9.0 dB	+7.5 dB	+21.0 dB

INPUT: DVD ANALOG
SPEAKER OUT: 1 kHz, SUBWOOFER OUTPUT: 50 Hz

Input level	Volume	SPEAKER OUT				SUBWOOFER OUTPUT
		FRONT L/R	CENTER	SURROUND L/R	SURROUND BACK L/R	
Both ch, -20 dBm	+6.0 dB	+12.0 dBm	+12.0 dBm	+12.0 dBm	+12.0 dBm	-7.0 dBm

RAM FULL BIT

The signal is output in digital full bit without including the head margin.
The SUBWOOFER signal is output but not in digital full bit.

RAM FULL BIT

ヘッドマージンを含まず、デジタルフルビットで出力されます。
SUBWOOFERは出力されますが、デジタルフルビットではありません。

2. RAM FULL BIT

FRONT L/R	CENTER	SURROUND L/R	SURROUND BACK L/R	SUBWOOFER
0 dB	0 dB	0 dB	0 dB	+21.0 dB

INPUT: DVD ANALOG
SPEAKER OUT: 1 kHz, SUBWOOFER OUTPUT: 50 Hz

Input level	Volume	SPEAKER OUT				SUBWOOFER OUTPUT
		FRONT L/R	CENTER	SURROUND L/R	SURROUND BACK L/R	
Both ch, -20 dBm	+6.0 dB	+12.0 dBm	+12.0 dBm	+12.0 dBm	+12.0 dBm	-7.0 dBm

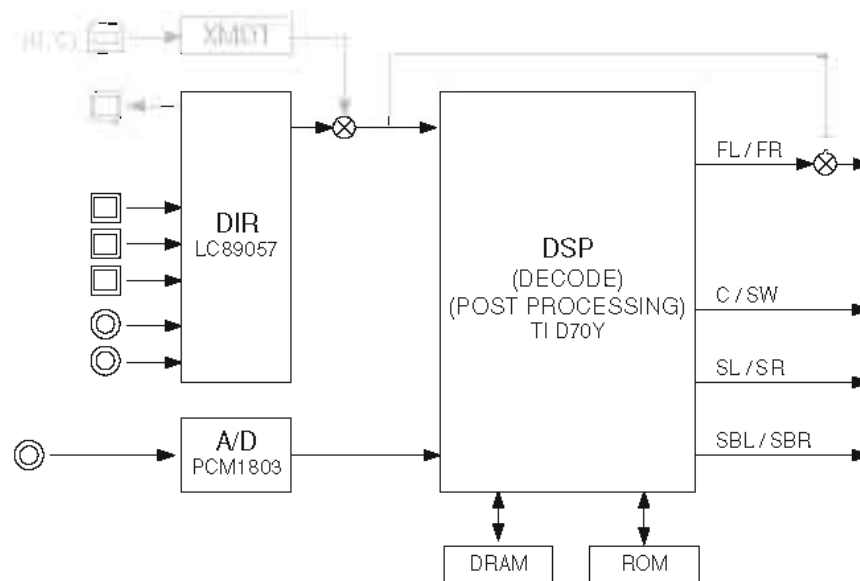

(Shaded items not used in this example)

When input source is stereo, signal is assigned as below.
2 ch信号入力時、以下のように信号を振り分けて出力します。

- Front L → Center / Surround L / Surround Back L, R
- Front R → Surround R
- Front L +10 dB → SWFR

3. HDMI AUDIO

The audio signals input to HDMI IN are selected by the sub-menu and output.

* When selecting "DSD", be sure to connect an HDMI unit equipped with DSD output function to this unit.

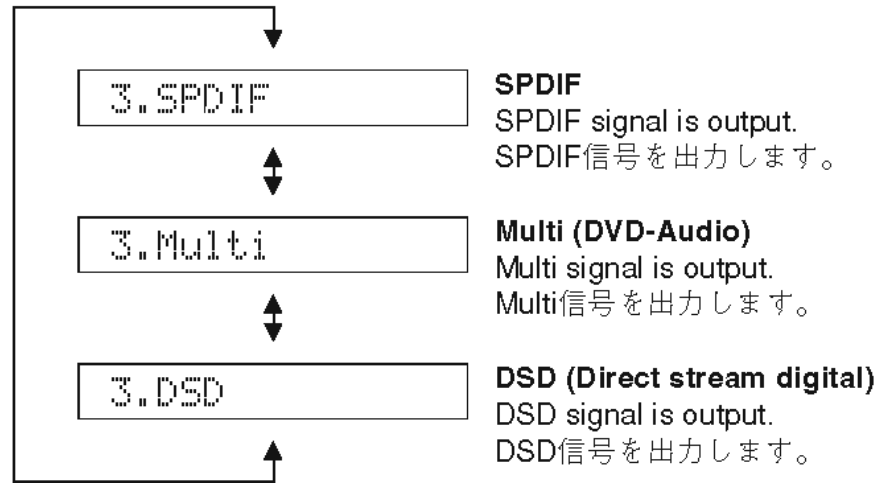

3. HDMI AUDIO

HDMI INに入力された音声信号をサブメニューで選択し、出力します。

※“DSD”を選択する場合、必ずDSD出力が可能なHDMI機器を接続してください。

4. SPEAKER SET

The analog switch settings for each sub-menu are as shown in the table below.

4. SPEAKER SET

各サブメニューにおけるアナログスイッチの設定は以下の通りです。

	FRONT L/R	CENTER	SURROUND L/R	SURROUND BACK L/R	SUBWOOFER
FRNT : SML 0dB	SMALL	LARGE	LARGE	LARGE	SWFR
CENTER : NONE	LARGE	NONE	LARGE	LARGE	SWFR
LFE/B : FRNT	LARGE	SMALL	SMALL	SMALL	FRONT
Pres Mix-P	LARGE	LARGE	LARGE	LARGE	SWFR
Pres Mix-F	LARGE	LARGE	LARGE	LARGE	SWFR
Zone2 Amp ON	LARGE	LARGE	LARGE	NONE (*)	SWFR
Bi-AMP	LARGE	LARGE	LARGE	NONE	SWFR
TONE : MAX	LARGE	LARGE	LARGE	LARGE	SWFR
TONE : MIN	LARGE	LARGE	LARGE	LARGE	SWFR

(*) ZONE2 L/R (EXTRA SP L/R): LARGE

LARGE: This mode is used for a speaker with high bass reproduction performance (a large unit). Full bandwidth signals are output.

SMALL: This mode is used for a speaker with low bass reproduction performance (a small unit). The signals of 90 Hz or less are mixed into the channel specified by LFE/BASS.

NONE: This mode is used for no center speaker. The center content is reduced by 3 dB and distributed to FRONT L/R.

SWFR: LFE of 5.1 ch signal or LFE/BASS lower than 90 Hz is output through SUBWOOFER OUT.

FRONT: LFE of 5.1 ch signal or LFE/BASS lower than 90 Hz is distributed to FRONT L/R.

LARGE: 低音再生能力の高い(ユニットの大きい)スピーカーを使用するモードです。全帯域が出力されます。

SMALL: 低音再生能力の低い(ユニットの小さい)スピーカーを使用するモードです。90 Hz以下がLFE/BASSで指定したチャンネルにミックスされます。

NONE: センタースピーカーを使用しないモードです。センター成分は-3 dBされて、FRONT L/Rに振り分けられます。

SWFR: 5.1 ch信号のLFEまたは90 Hz以下のLFE/BASSがSUBWOOFER OUTに出力されます。

FRONT: 5.1 ch信号のLFEまたは90 Hz以下のLFE/BASSをFRONT L/Rに振り分けます。

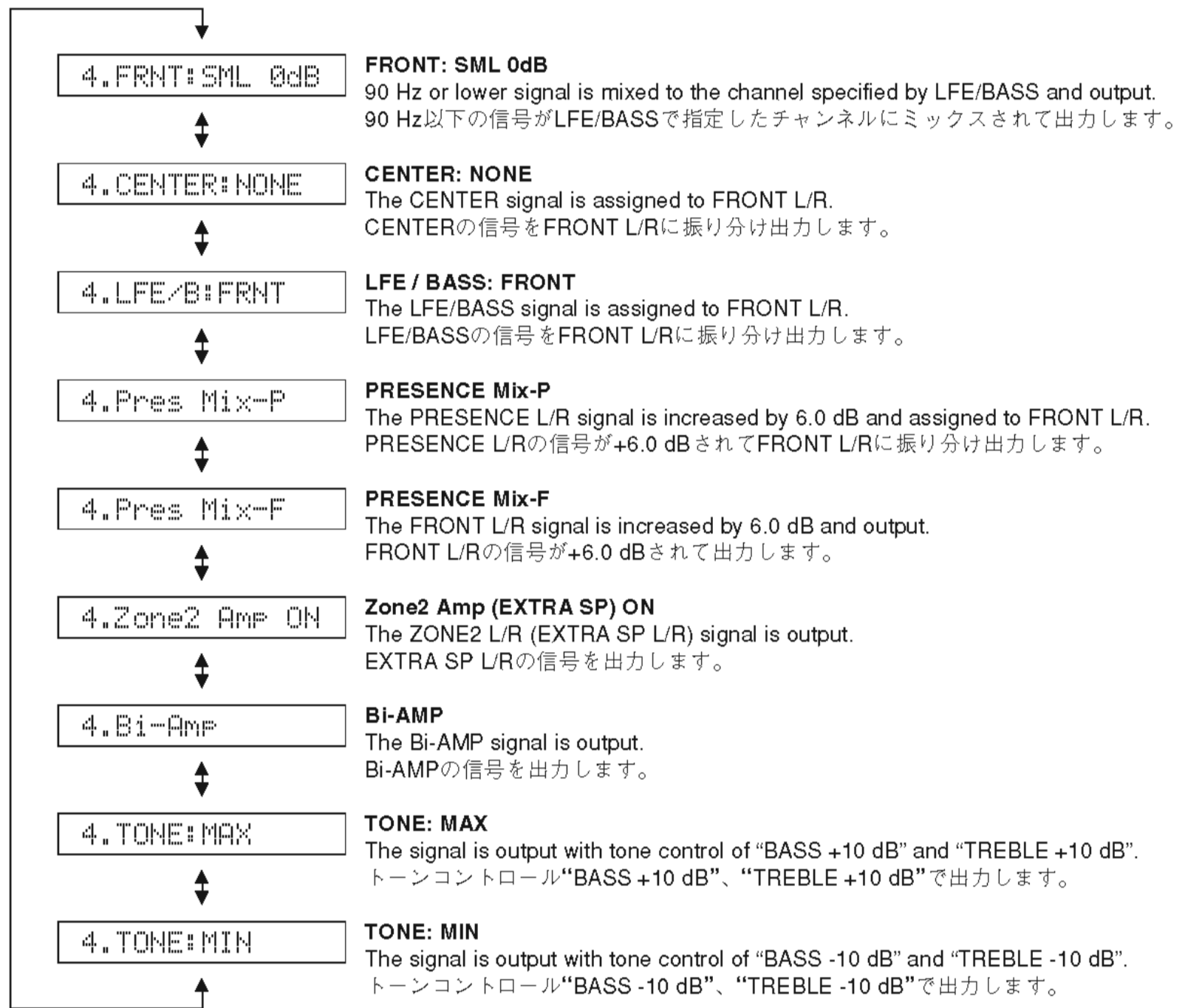

INPUT: DVD ANALOG
SPEAKER OUT: 1 kHz, SUBWOOFER OUTPUT: 50 Hz

Sub-menu	Input level	Volume	SPEAKER OUT				SUBWOOFER OUTPUT
			FRONT L/R	CENTER	SURROUND L/R	SURROUND BACK L/R	
FRNT : SML 0dB	Both ch, -20 dBm	+6.0 dB	+12.0 dBm	+12.0 dBm	+12.0 dBm	+12.0 dBm	-3.0 dBm
CENTER : NONE	Both ch, -20 dBm	+6.0 dB	+9.0 dBm	-∞	+12.0 dBm	+12.0 dBm	-7.0 dBm
LFE/B : FRNT (50 Hz)	Both ch, -20 dBm	+6.0 dB	+25.0 dBm	+3.0 dBm	+3.0 dBm	+3.0 dBm	-∞
Pres Mix-P	Both ch, -20 dBm	+6.0 dB	+12.0 dBm	+12.0 dBm	+12.0 dBm	+12.0 dBm	-7.0 dBm
Pres Mix-F	Both ch, -20 dBm	+6.0 dB	+12.0 dBm	+12.0 dBm	+12.0 dBm	+12.0 dBm	-7.0 dBm
Zone2 Amp ON	Both ch, -20 dBm	+6.0 dB	+12.0 dBm	+12.0 dBm	+12.0 dBm	-∞ (*)	-7.0 dBm
Bi-AMP	Both ch, -20 dBm	+6.0 dB	+12.0 dBm	+12.0 dBm	+18.0 dBm	+12.0 dBm	-7.0 dBm
TONE : MAX	Both ch, -20 dBm	+6.0 dB	+12.0 dBm	+12.0 dBm	+12.0 dBm	+12.0 dBm	-7.0 dBm
TONE : MIN	Both ch, -20 dBm	+6.0 dB	+11.0 dBm	+12.0 dBm	+12.0 dBm	+12.0 dBm	-7.0 dBm

(*) ZONE2 L/R (EXTRA SP L/R) SPEAKER OUT: +12.0 dBm

5. XCH-INPUT

The input source "MULTI CHANNEL INPUT" is selected.

It is possible to select the 6 ch/8 ch and 6-ohm/8-ohm by using the sub-menu.

When LIM / PLDET / THM menu is selected, it is possible to move to the next self-diagnostic function menu by turning the "PROGRAM" knob of this unit.

6 ch INPUT 6-ohm

5.6CH INPUT_6Ω

INPUT: MULTI CH INPUT
SPEAKER OUT: 1 kHz, SUBWOOFER OUTPUT: 50 Hz

Input level	Volume	SPEAKER OUT				SUBWOOFER OUTPUT
		FRONT L/R	CENTER	SURROUND L/R	SURROUND BACK L/R	
Both ch, -20 dBm	+6.0 dB	+12.0 dBm	+12.0 dBm	+12.0 dBm	-∞	-18.0 dBm

8 ch INPUT 6-ohm

5.8CH INPUT_6Ω

INPUT: MULTI CH INPUT
SPEAKER OUT: 1 kHz, SUBWOOFER OUTPUT: 50 Hz

Input level	Volume	SPEAKER OUT				SUBWOOFER OUTPUT
		FRONT L/R	CENTER	SURROUND L/R	SURROUND BACK L/R	
Both ch, -20 dBm	+6.0 dB	+12.0 dBm	+12.0 dBm	+12.0 dBm	+12.0 dBm	-18.0 dBm

6 ch INPUT 8-ohm

5.6CH INPUT_8Ω

INPUT: MULTI CH INPUT
SPEAKER OUT: 1 kHz, SUBWOOFER OUTPUT: 50 Hz

Input level	Volume	SPEAKER OUT				SUBWOOFER OUTPUT
		FRONT L/R	CENTER	SURROUND L/R	SURROUND BACK L/R	
Both ch, -20 dBm	+6.0 dB	+12.0 dBm	+12.0 dBm	+12.0 dBm	-∞	-18.0 dBm

8 ch INPUT 8-ohm

5.8CH INPUT_8Ω

INPUT: MULTI CH INPUT
SPEAKER OUT: 1 kHz, SUBWOOFER OUTPUT: 50 Hz

Input level	Volume	SPEAKER OUT				SUBWOOFER OUTPUT
		FRONT L/R	CENTER	SURROUND L/R	SURROUND BACK L/R	
Both ch, -20 dBm	+6.0 dB	+12.0 dBm	+12.0 dBm	+12.0 dBm	+12.0 dBm	-18.0 dBm

5. XCH-INPUT

入力ソース"MULTI CHANNEL INPUT"が選択されます。

サブメニューにより、6 ch/8 ch入力および6オーム/8オームが選択可能です。

LIM / PLDET / THMのメニューにすると、キー操作はできなくなりますが、本機の"PROGRAM"ツマミを回すことにより、次のダイアグメニューに進めることができます。

6 ch INPUT 6-ohm

8 ch INPUT 6-ohm

6 ch INPUT 8-ohm

8 ch INPUT 8-ohm

LIM / PLDET / THM

LIM: Setting value of LIM (Limiter control)

* Do not change the value settings because this menu is only for the use of development staff.

PLDET: Power limiter detection

The A/D conversion value during operation is displayed.

(Reference voltage: 5.0 V=255)

THM: Thermo protection detection

The A/D conversion value during operation is displayed.

(Reference voltage: 5.0 V=255)

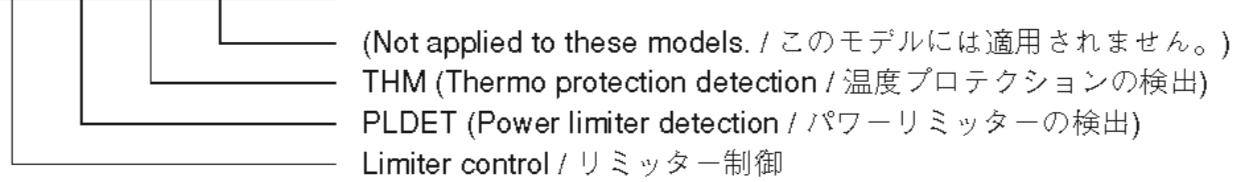
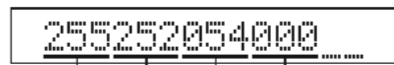

LIM / PLDET / THM

LIM: LIM(リミッター制御)の設定値

※ 開発スタッフ専用メニューですので、設定値の変更は行わないでください。

PLDET: パワーリミッターの検出

動作時のA/D変換値が表示されます。
(基準電圧: 5.0 V=255)

THM: 温度プロテクションの検出

動作時のA/D変換値が表示されます。
(基準電圧: 5.0 V=255)

6. MIC CHECK

The signals input through the microphone are output of FRONT L/R via A/D and D/A.

6. MIC CHECK

マイク入力された信号をA/D-D/A経由でFRONT L/Rに出力します。



The output level is not indicated.
出力レベルは表示されません。

8. MANUAL TEST

Noise is output to all channels through the noise generation circuit which is included in the microprocessor. The noise frequency for LFE (SUBWOOFER) is 35 to 80 Hz. Other than that, the noise frequency is 500 to 2 kHz.

TEST ALL

Noise is output from all channels.

8. TEST ALL

9. A/D DATA CHECK

This menu is used to display the A/D conversion value of the microprocessor which detects panel keys of this unit and protection functions in using the sub-menu. During signal processing, the condition before execution is maintained.

When K0/K1 menu is selected, keys become non-operable due to detection of the values of all keys. However, it is possible to move to the next self-diagnostic function menu by turning the PROGRAM knob of this unit.

* The figures in the diagram are given as reference only.

PS1/PS2

PSx: Power supply voltage protection detection

PS1

Voltage detects: AC_BH, AC_BL, AC12, AC5, +10, +5.3H and +XM (U, C models)

Normal value: 110 to 205 (Reference voltage: 5.0 V=255)

PS2

Voltage detects: +12, -12, +5V, +5D, +5I and +3.3D

Normal value: 88 to 140 (Reference voltage: 5.0 V=255)

* If PS1 and PS2 are out of the normal value range, the protection function works to turn off the power.

PS1:144 2:112

8. MANUAL TEST

マイコンに内蔵されているノイズ発生回路によって、全チャンネルへノイズを出力します。

LFE (SUBWOOFER)用のノイズ周波数は35～80 Hz、それ以外はノイズ周波数500～2 kHzとなります。

TEST ALL

全チャンネルからノイズを出力します。

9. A/D DATA CHECK

本機パネルキー、プロテクションなどを検出しているマイコンのA/D変換値を、サブメニューで表示します。信号処理は実行前の状態を維持します。

K0/K1のメニューにすると、全キーの値を検出するためキー操作はできなくなりますが、本機の“PROGRAM”ツマミを回すことにより、次のダイアグメニューに進めることができます。

※ 図中の数値は参考例です。

PS1/PS2

PSx: 電源電圧プロテクションの検出

PS1

検出電圧: AC_BH、AC_BL、AC12、AC5、+10、+5.3H

正常値: 110～205 (基準電圧: 5.0 V=255)

PS2

検出電圧: +12、-12、+5V、+5D、+5I、+3.3D

正常値: 88～140 (基準電圧: 5.0 V=255)

※ PS1およびPS2は正常値を外れるとプロテクションが働き、電源オフされます。

DC/TH

DC: Power amplifier DC protection detection
Power amplifier DC (DC voltage) output is detected.
Normal value: 5 to 36 (Reference voltage: 5.0 V=255)

TH: THM (Thermo protection detection)
Temperature of the heat sink is detected.
Normal value: 0 to 124 (Reference voltage: 5.0 V=255)

* If THM is out of the normal value range, the protection function works to turn off the power.

DC:020 TH:054

DC/TH

DC: パワーアンプDCプロテクションの検出
パワーアンプDC(直流電圧)出力の検出
正常値: 5~36(基準電圧: 5.0 V=255)

TH: THM(温度プロテクションの検出)
ヒートシンク温度の検出
正常値: 0~124(基準電圧: 5.0 V=255)

※ THMは正常値を外れるとプロテクションが働き、電源オフされます。

IMP/PL

IMP: 8 or 4 ohms impedance setup detection
IMP 8: 8 ohms setting
IMP 4: 6 ohms setting

PL: PLDET (Power limiter detection)
Power amplifier output voltage detection
The power amplifier output voltage is detected and the power amplifier input voltage is controlled.

IMP:8 PL:252

TH/PL

IMP: インピーダンス設定の検出
このモデルには適用されません。

PL: PLDET(パワーリミッターの検出)
パワーアンプ出力電圧の検出
パワーアンプ出力電圧を検出して、パワーアンプ入力電圧を制御します。

U, C, T, K, A, B, G, E, F models (Reference voltage: 5.0 V=255)

	During normal operation	Value for starting limiter operation	Value for canceling limiter operation
PLDET (8-ohm/6-ohm)	255 / 255	87 / 146	125 / 171
LIM (Limiter control)	H	L	H

R, L models (Reference voltage: 5.0 V=255)

	During normal operation	Value for starting limiter operation	Value for canceling limiter operation
PLDET (8-ohm/6-ohm)	255 / 255	100	131
LIM (Limiter control)	H	L	H

J model (基準電圧 : 5.0 V=255)

	通常値	リミッタ動作開始値	リミッタ動作解除値
PLDET (8-ohm/6-ohm)	255 / 255	100	131
LIM (リミッター制御)	H	L	H

DST/DK

DST: Destination detection
(Reference voltage: 5V=255)

DK: DOCK type detection
(Reference voltage: 5V=255)

DST/DK

DST : 仕向けの検出
(基準電圧：5V=255)

DK : DOCKタイプの検出
(基準電圧：5V=255)

DST:027DK:252

Destination detection for AD port
Pull-up resistance 10 k-ohms

Ohm	0.0 k	1.2 k	2.7 k	4.7 k	6.8 k	10.0 k	15.0 k	27.0 k	47.0 k	100.0 k	-
V	0-0.3	0.4-0.7	0.8-1.3	1.4-1.8	1.9-2.2	2.3-2.7	2.8-3.2	3.3-3.8	3.9-4.3	4.4-4.7	4.8-5.0
A/D (5 V=255)	0-13	14-40	41-68	69-92	93-115	116-140	141-170	171-198	199-221	222-243	245-255
DEST, 139pin	J	U, C	-	R	T	K	A	B	G, E, F	L	-

DOCK detection for AD port (IC30 Microprocessor pin no. 128)
Pull-up resistance 10 k-ohms

DOCK type	DOCK (Bluetooth)	Reserved	Reserved	DOCK (iPod)	Reserved	(Development)	No connect
Ohm	0.56k	2.7k	5.6k	10.0k	18.0k	39.0k	-
DKID (Pin no. 21)	5-25	50-60	85-100	120-140	150-170	195-210	245-255

K0/K1

K0/K1: KEY0/KEY1 (Panel key of main unit)
 The key will fail to function properly if its A/D conversion value deviates from the specific range. In that case, check the constant of partial pressure resistor, solder condition, etc. with referring to the table below.
 (Reference voltage: 5.0 V=100)

K0/K1

K0/K1: KEY0/KEY1 (本機パネルキー)
 キーのA/D値は基準値から外れると、正常な動きをしません。
 下表をご覧になり、各キーの分圧抵抗の定数、ハンダ不良等の確認をしてください。
 (基準電圧：5.0 V=100)

K0:255 K1:255

RX-V863 (U, C, R, T, K, A, G, E, F, L models) / HTR-6180 (U, F models)

Display / 表示	KEY0	KEY1
0 - 4	SYSTEM OFF	Zone2 ON/OFF
5 - 13	SCENE1	SCENE3
14 - 21	SCENE2	SCENE4
22 - 31	-	ZONE CONTROL
32 - 42	-	AUDIO SELECT
43 - 53	STRAIGHT	BAND
54 - 61	TONE CONTROL	A/B/C/D/E
62 - 68	SEARCH MODE /EDIT	PRESET <
69 - 75	-	PRESET >
76 - 82	SPEAKERS	MEMORY
83 - 89	PURE DIRECT	INFO
90 - 100	KEY OFF	KEY OFF

HTR-6180 (C model) / DSP-AX863 (J model)

Display / 表示	KEY0	KEY1
0 - 4	-	MUTE
5 - 13	SCENE1	SCENE3
14 - 21	SCENE2	SCENE4
22 - 31	-	SLEEP
32 - 42	-	AUDIO SELECT
43 - 53	STRAIGHT	BAND
54 - 61	TONE CONTROL	A/B/C/D/E
62 - 68	SEARCH MODE /EDIT	PRESET <
69 - 75	-	PRESET >
76 - 82	SPEAKERS	MEMORY
83 - 89	PURE DIRECT	INFO
90 - 100	KEY OFF	KEY OFF

DSP-AX863SE (B model)

Display / 表示	KEY0	KEY1
0 - 4	-	-
5 - 13	SCENE1	SCENE3
14 - 21	SCENE2	SCENE4
22 - 31	-	-
32 - 42	-	AUDIO SELECT
43 - 53	STRAIGHT	-
54 - 61	TONE CONTROL	-
62 - 68	-	-
69 - 75	-	-
76 - 82	SPEAKERS	-
83 - 89	PURE DIRECT	-
90 - 100	KEY OFF	KEY OFF

10. VIDEO CHECK

The video circuit is checked by the sub-menu operation.

I2C (Inter integrated circuit) read/write check

Self-diagnosis is executed to check whether data reading/writing between the microprocessor connected to the I2C line and each IC is done properly or not.

10. VIDEO CHECK

サブメニュー操作により、ビデオ回路の確認をします。

I2C (Inter integrated circuit) read/write check

I2Cラインに接続されているマイコンと各IC間でデータ読み出し/書き込みの正否を自己診断します。

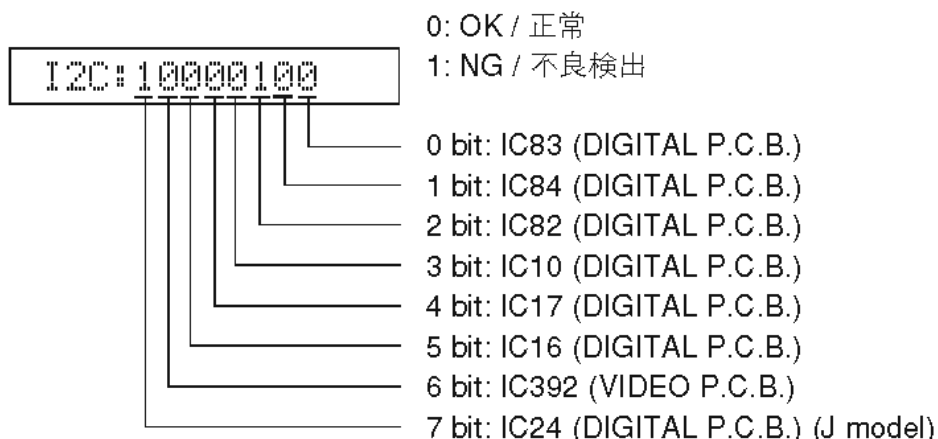

Digital component

The signal passage as shown below is checked.

Digital component

下記の信号経路を確認します。

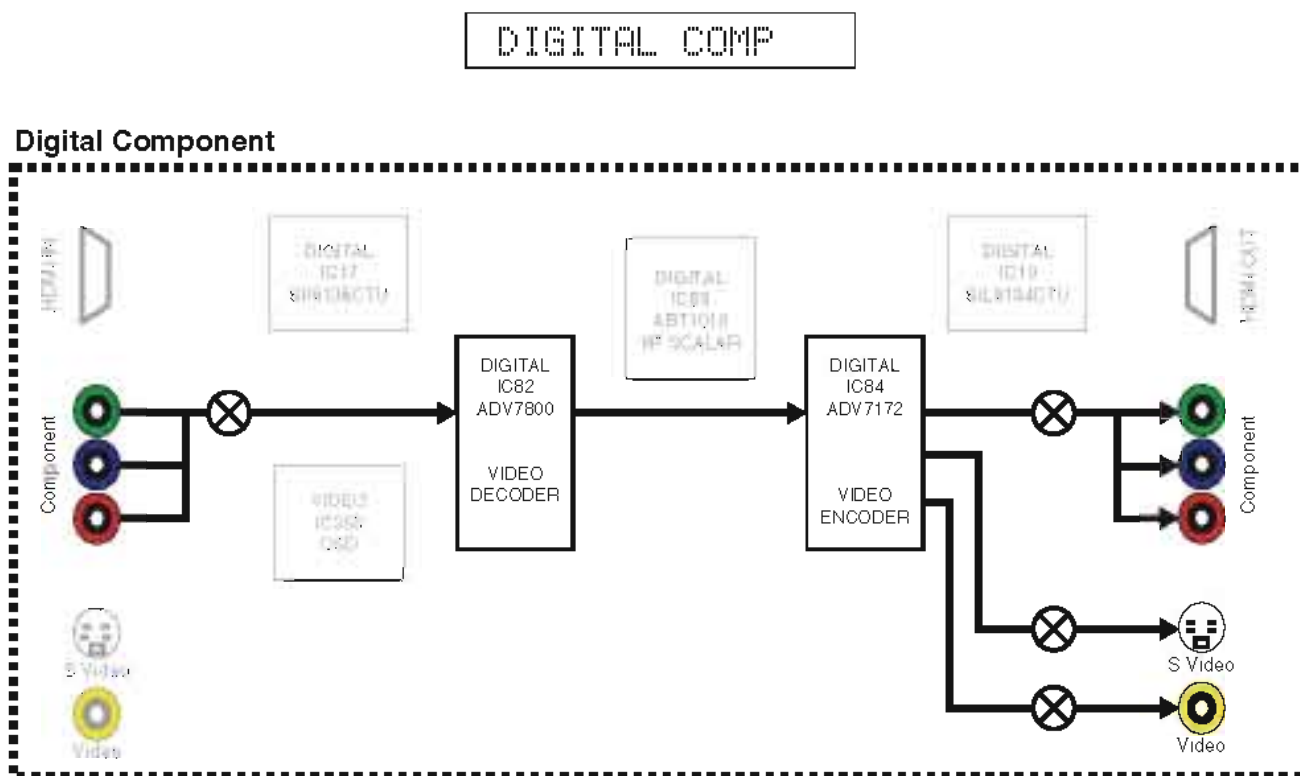

Digital CVBS (Video)

The signal passage as shown below is checked.

Digital CVBS (Video)

下記の信号経路を確認します。

DIGITAL CVBS

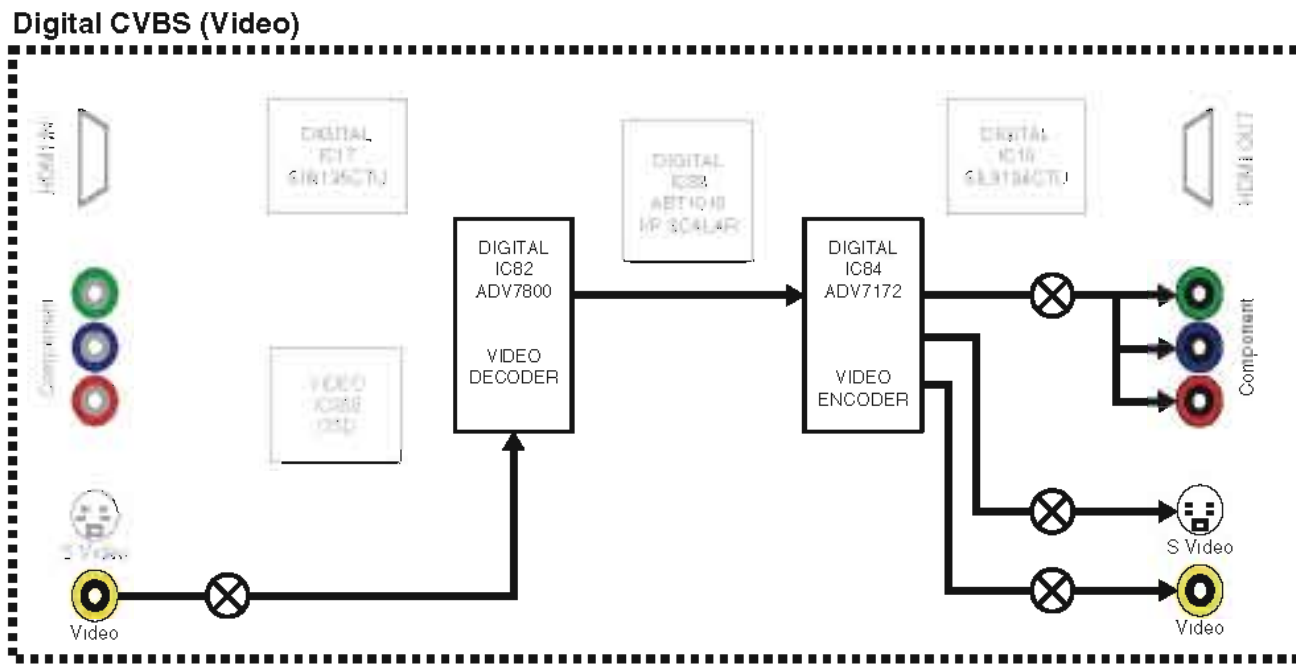

Digital Y/C (S-Video)

The signal passage as shown below is checked.

Digital Y/C (S-Video)

下記の信号経路を確認します。

DIGITAL Y/C

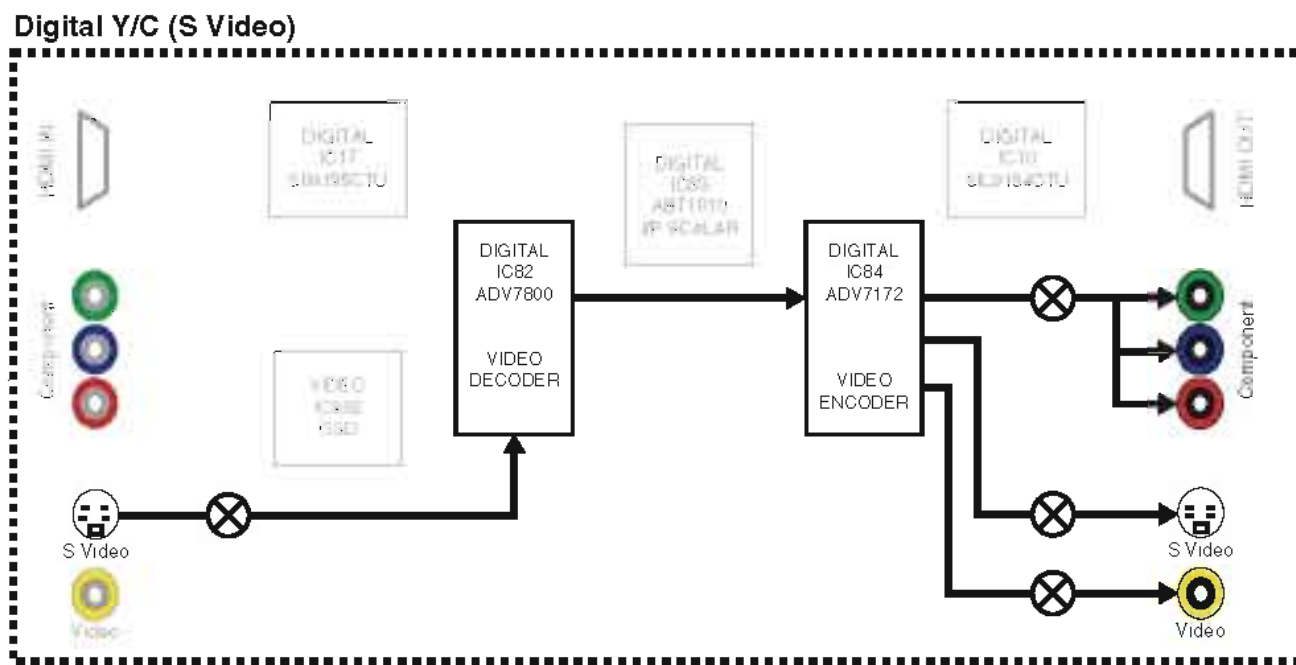

Analog bypass

The signal passage as shown below is checked.

Analog bypass

下記の信号経路を確認します。

ANALOG BYPASS

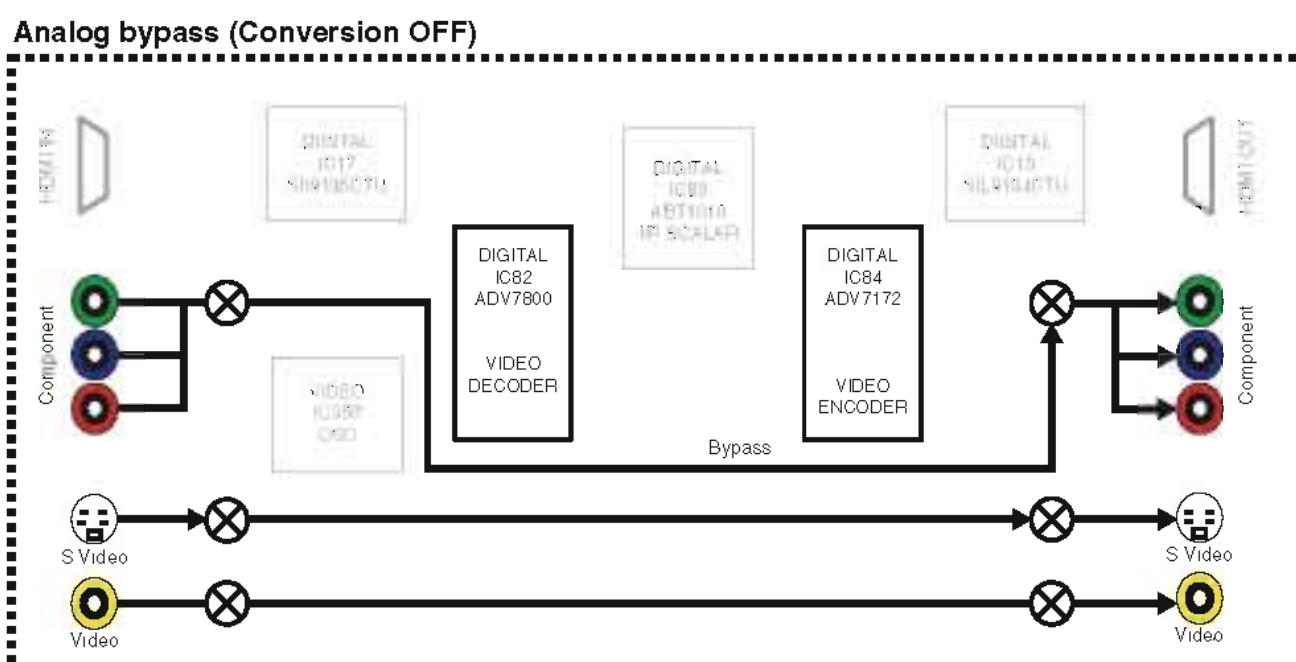

Test pattern

The test pattern is output from IC84 (DIGITAL P.C.B.).

Test pattern

IC84 (DIGITAL P.C.B.) からテストパターンを出力します。

TEST PATTERN

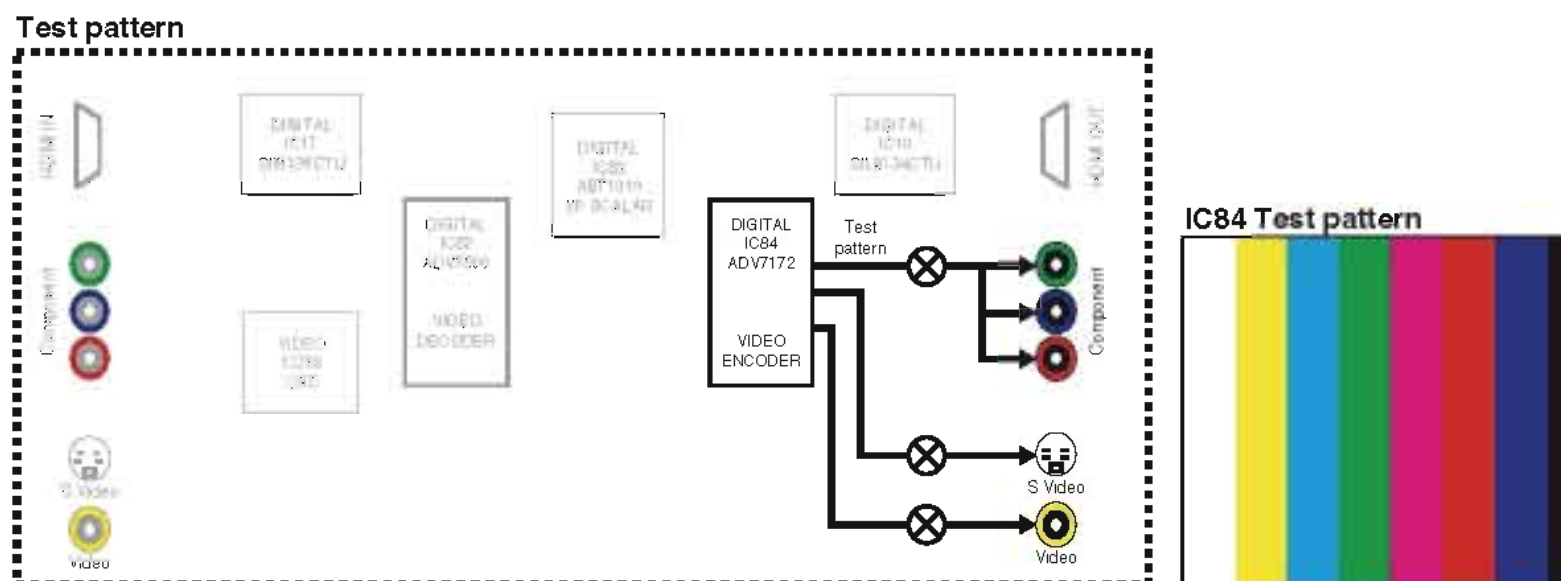

Video information

Displays the information of image signals being input.

Video information

入力されている映像信号の情報を表示します。

Example / 例

VIDEO IN 480i

11. XM STATUS (U, C models)

The output check of XM radio is executed.
 (Connect XM radio antenna module to this unit before executing.)

11. XM STATUS (U, C models)

このモデルには適用されません。

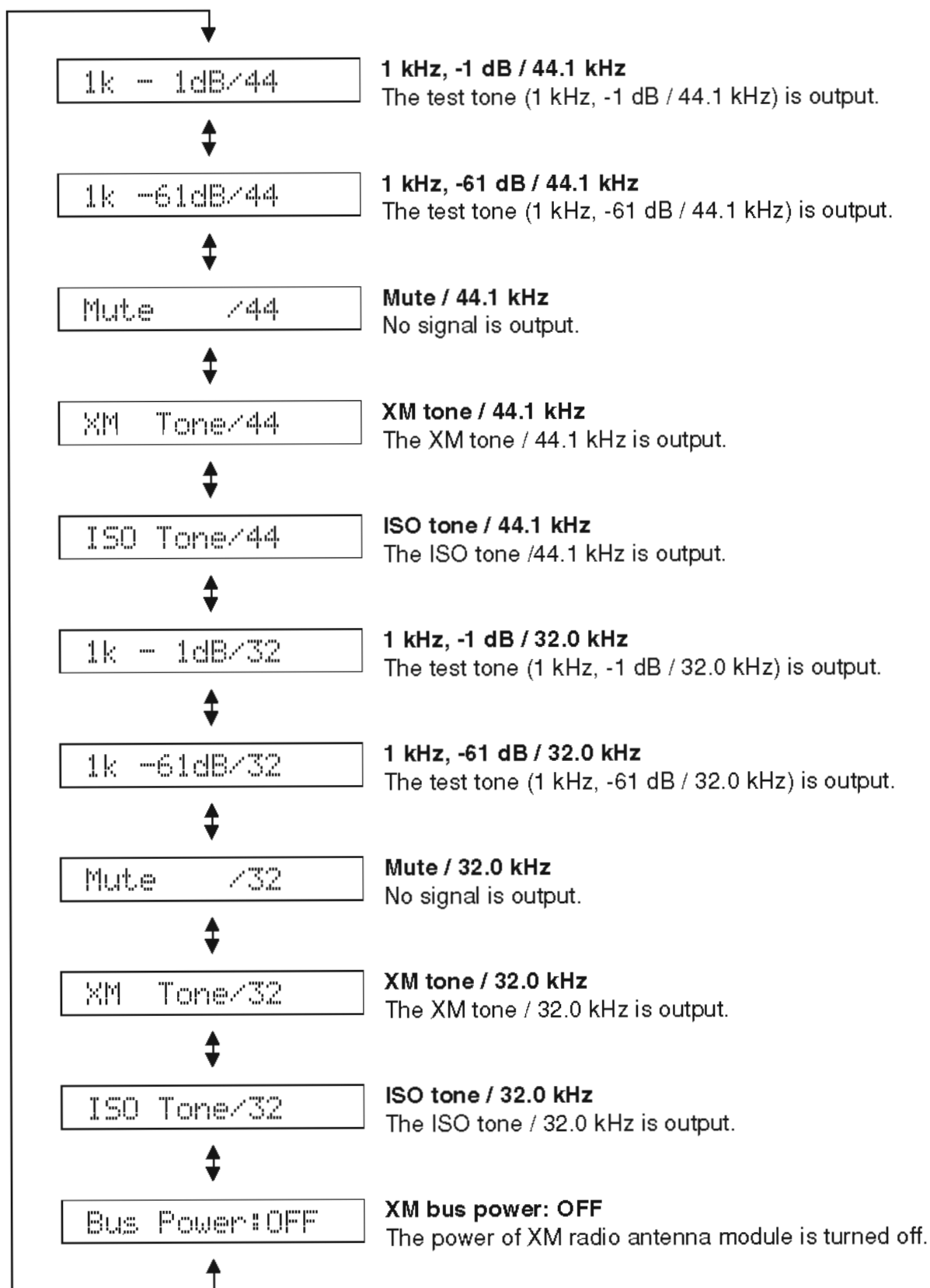

12. SIRIUS (U, C models)

The SIRIUS version is displayed.

12. SIRIUS(U, C models)

このモデルには適用されません。

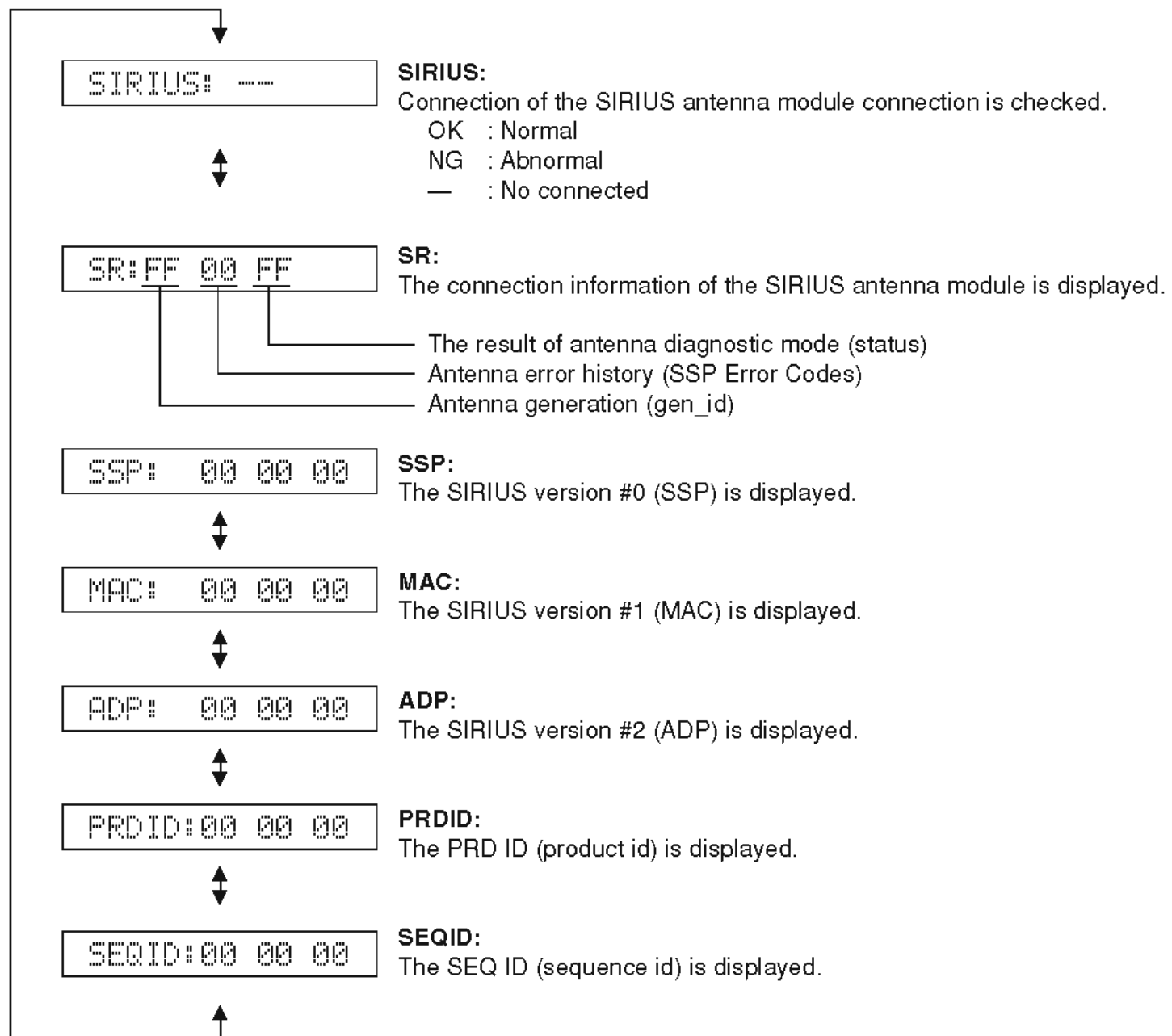

13. HD RADIO (U model)

CPU version

The sub-microprocessor version in HD radio module is displayed.

13. HD RADIO(U model)

このモデルには適用されません。

CPU version

HD CPU U:09.13

DSP version

The DSP version in HD radio module is displayed.

DSP version

D:DRI-352-U016

14. DOCK

This menu is used to test the DOCK connector without the iPod itself.

After turning off the power, short between pins No. 14 (TX) and No. 18 (RX), between pins No. 1 (PWR) and No. 17 (ACCPOW) and between pins No. 4 (iPDET) and No. 8 (DGND).

Start the self-diagnostic function and select the menu. The check result is displayed according to the following display specifications.

Note) Be sure to return the shorted locations to their original state.

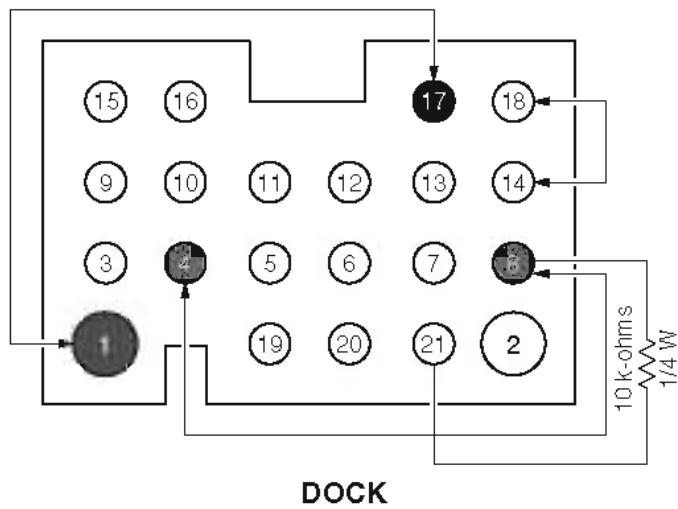

14. DOCK

iPod本体無しで、DOCKコネクタの検査を行うメニューです。

電源オフの状態にしてから、DOCKコネクタの14ピン(TX)と18ピン(RX)、1ピン(PWR)と17ピン(ACCPOW)、4ピン(iPDET)と8ピン(DGND)をショートさせます。

ダイアグを起動してメニューを選択します。下記表示仕様に従って、チェック結果が表示されます。

注) ショート箇所は、必ず元に戻してください。

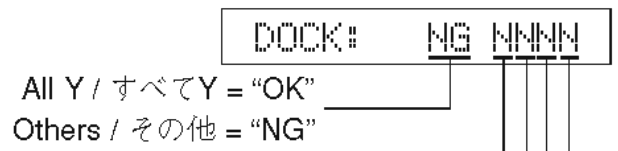

Check item / チェック項目	Short pins / ショートピン	Result / 結果	Display / 表示
UART loop back test / UARTループバックテスト	Pins No.14 (TX) – No.18 (RX)	OK	Y
		NG	N
iPAP (iPod accessory power) detection / iPAP (iPod accessory power)検出	Pins No.1 (PWR) – No.17 (ACCPOW)	IC30 pin No. 141 High	Y
		IC30 pin No. 141 Low	N
iPDET (iPod installation to DOCK) detection / iPDET (iPod installation to DOCK)検出	Pins No.4 (iPDET) – No.8 (DGND)	IC30 pin No. 4 Low	Y
		IC30 pin No. 4 High	N
DKID (DOCK ID) detection / DKID (DOCK ID)検出	Pins No.21 (DKID) – No.8 (DGND) * 10 k-ohms, 1/4 W pull down	IC30 pin No. 28 10 k-ohms, 1/4 W pull down	Y
		IC30 pin No. 28 Other	N

15. HDMI INFORMATION

15. HDMI INFORMATION

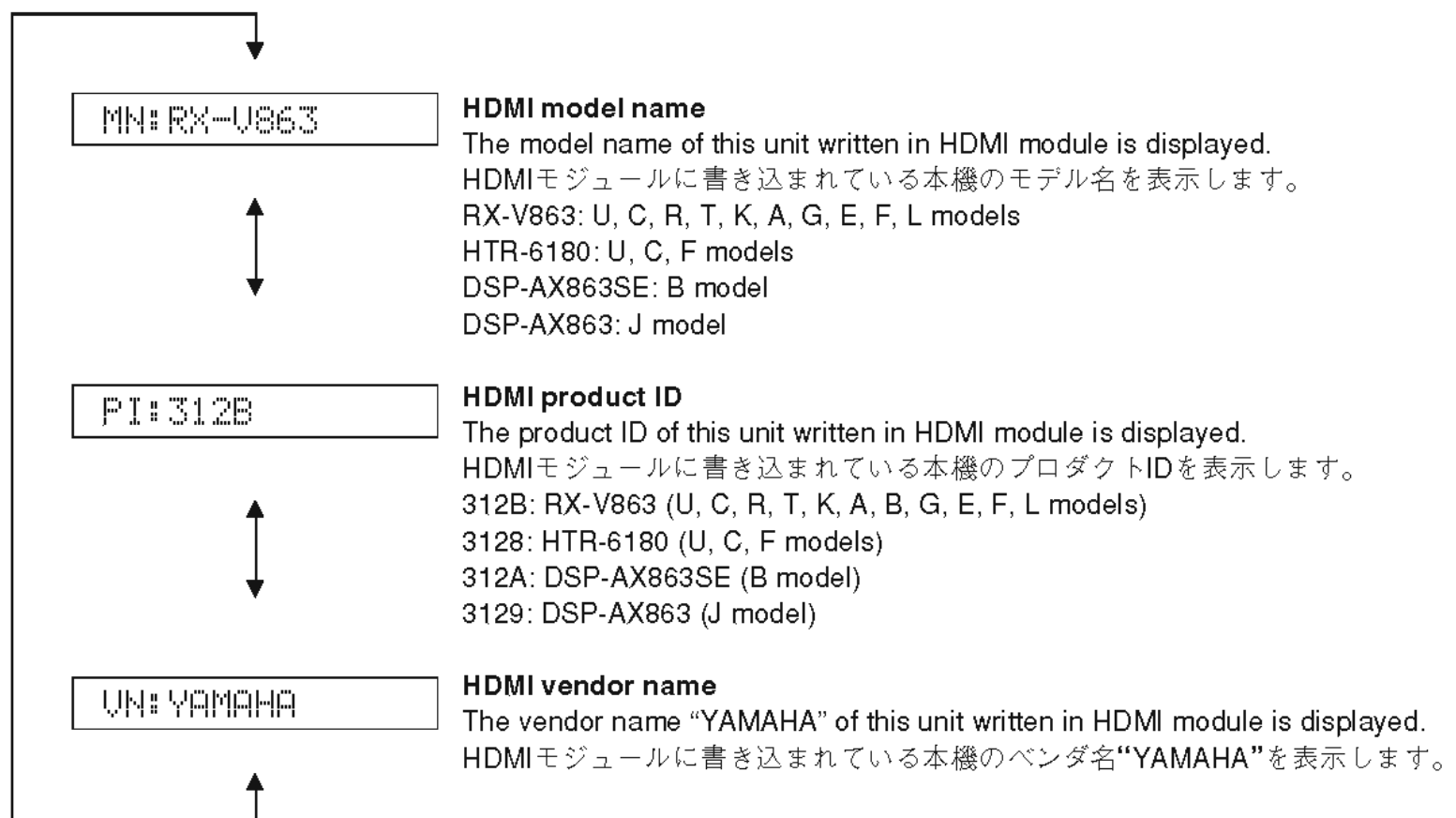

16. HDMI SELECT

The selected input signal is output to HDMI OUT by the sub-menu operation.

* Support audio is set to "OTHER".

16. HDMI SELECT

サブメニュー操作により、選択された入力信号をHDMI OUTへ出力します。

※ SUPPORT AUDIOは"OTHER"に設定されます。

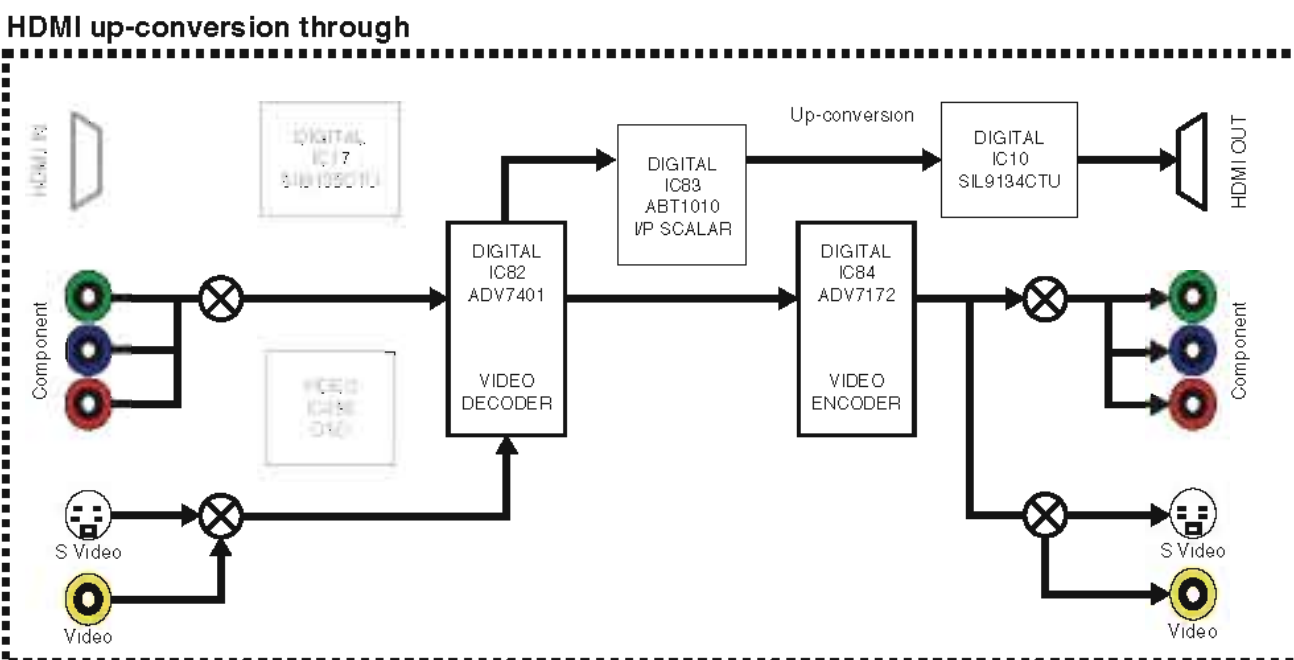
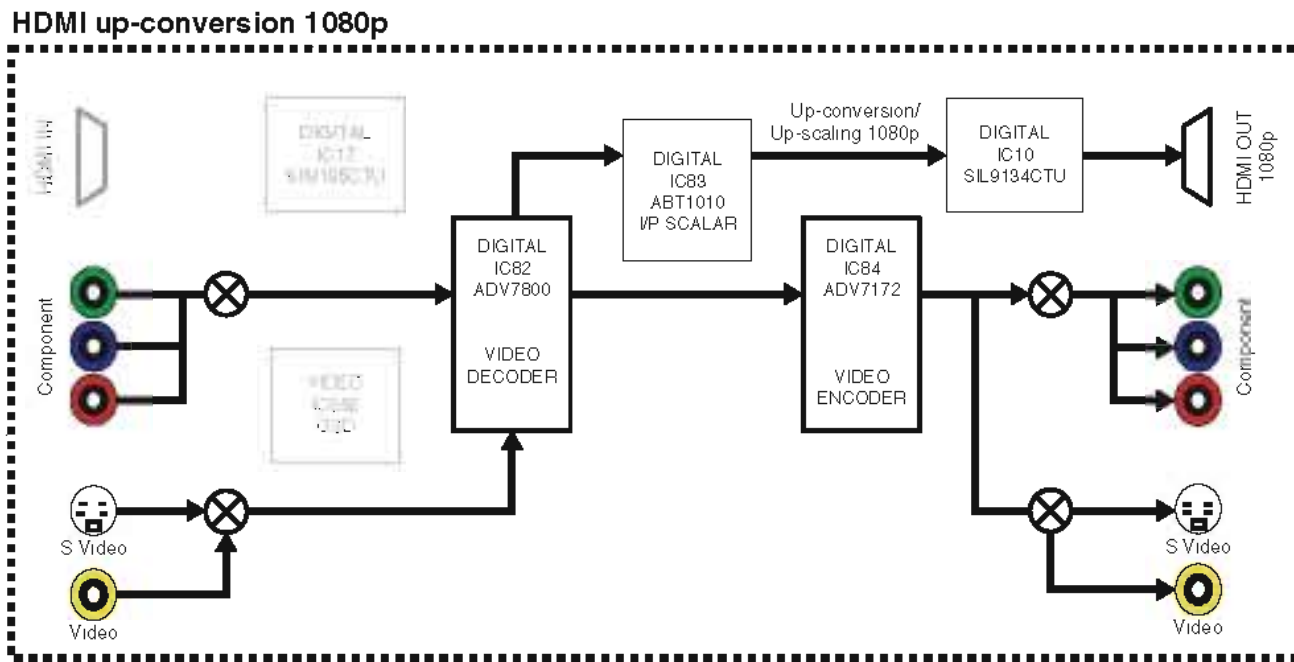
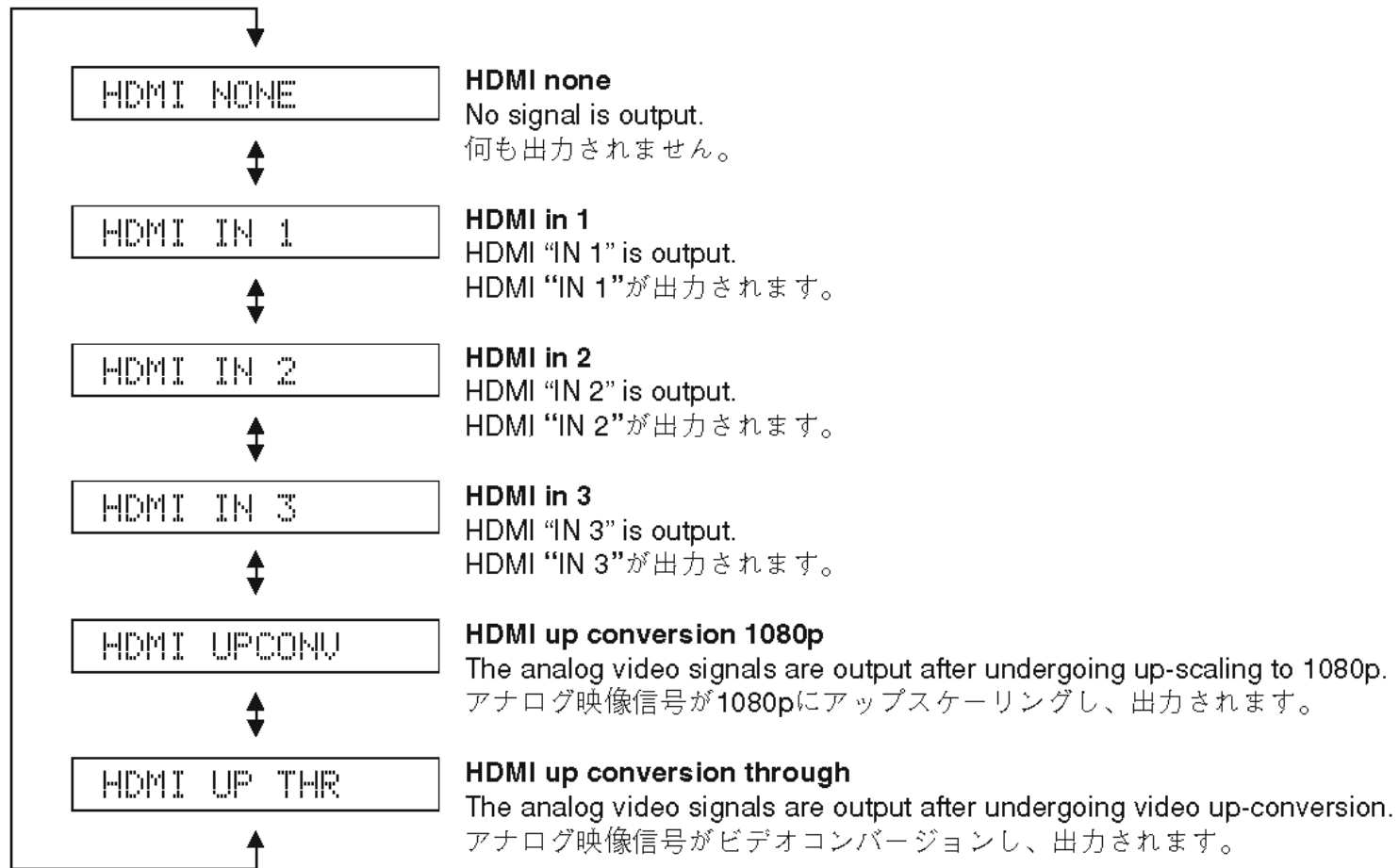

17. IF STATUS (Input function status)

The status information is displayed in the hexadecimal notation one after another by the sub-menu operation.

For signal processing, the status before the sub-menu operation is maintained.

- * Mentioning the details is not allowed because this menu is only for the use of development staff.
- * The figures in the diagram are given as reference only.

```
DST:3000020000
```

DSP status

17. IF STATUS (Input function status)

サブメニュー操作により、ステータス情報を順次16進数で表示します。

信号処理は、サブメニュー操作前の状態を維持します。

- ※ 開発スタッフ専用メニューですので、詳細を記述することはできません。
- 図中の数値は参考例です。

18. DSP BUS CHECK

This menu is used to self-diagnose whether or not the bus connection for the TI (DA70Y) and the external ROM/RAM is made properly.

```
TI BUS:NoEr
```

- NoEr:** No error detected.
- Boot:** When "Boot" is displayed for a few seconds or "Boot" and "NoEr" are displayed alternately, there is possibility that an error occurs.

18. DSP BUS CHECK

TI (DA70Y) と外付けROM/RAMとのバス接続の正否を自己診断します。

- NoEr:** 不良検出なし
- Boot:** “Boot” が数秒間表示されるまたは “Boot” と “NoEr” が交互に表示される場合、異常が発生している可能性があります。

19. RESERVED

19. RESERVED

20. PROTECTION HISTORY

Four protection histories are displayed.

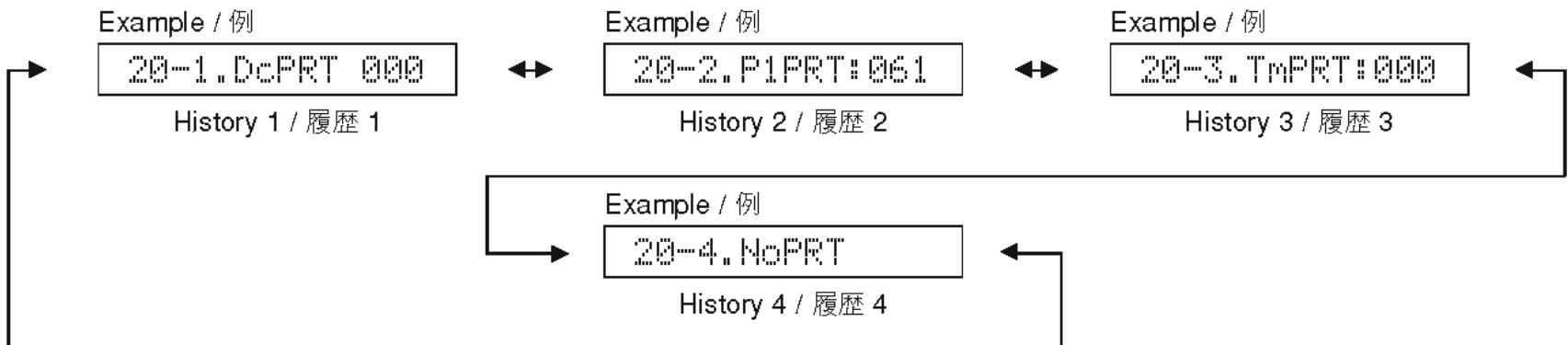

20. PROTECTION HISTORY

過去のプロテクション履歴が4つまで表示されます。

21. RESERVED

21. RESERVED

22. UPDATE

Not applied to these models.

22. UPDATE

このモデルには適用されません。



23. FACTORY PRESET

This menu is used to reserve/inhibit initialization of the user memory (Parameters and set menu contents, etc. of the sound field program).

The signals are processed using EFFECT OFF (The L/R signal is output using ANALOG BYPASS).

23. FACTORY PRESET

ユーザーメモリ (音場プログラムのパラメーターやセットメニュー内容等) の初期化を予約/禁止します。

信号処理はEFFECT OFF (ANALOG BYPASSでL/Rを出力) です。

23.PRESET INHI



23.PRESET RSRV

PRESET INHIBIT (Initialization inhibited) / PRESET INHIBIT (初期化禁止)

User memory initialization is not executed. Select this sub-menu to protect the user memory.

ユーザーメモリの初期化は行われません。ユーザーメモリを保護するときは、こちらを選択してください。

PRESET RESERVED (Initialization reserved) / PRESET RESERVED (初期化予約)

Initialization of the use memory is reserved. (Actually, initialization is executed the next time that the power is turned on.)

Select this sub-menu to reset to the original factory settings or to reset the use memory.

Any protection history will be cleared.

ユーザーメモリの初期化が予約されます。(実際に初期化されるのは、次回の電源投入時です。)

工場出荷時やユーザーメモリをリセットしたいときは、こちらを選択してください。

このとき、プロテクション履歴も初期化されます。

CAUTION: Before setting to the PRESET RESERVED, write down the existing preset memory content of the tuner in a table as shown below. (This is because setting to the PRESET RESERVED will cause the user memory content of the tuner to be erased.)

注意: PRESET RESERVEDを選んで初期化をする前に、チューナーのユーザーメモリー内容を下表に書き写してください。(初期化をすると、チューナーのユーザーメモリーの内容は消えてしまいます。)

Preset Group	P1	P2	P3	P4	P5	P6	P7	P8
A								
B								
C								
D								
E								

24. ROM VER. / SUM / PORT

The firmware version and checksum value are displayed. The signal is processed using EFFECT OFF. The checksum is obtained by adding the data at every 8-bit for each program area and expressing the result as a 4-figure hexadecimal data.

* The figures in the diagram are given as reference only.

24. ROM VER. / SUM / PORT

ファームウェアのバージョン、チェックサムを表示します。信号はエフェクトオフです。

チェックサムは、プログラムエリア別にデータを8ビットごとに加算していき、4桁の16進データで現したものです。

※ 図中の数値は参考例です。

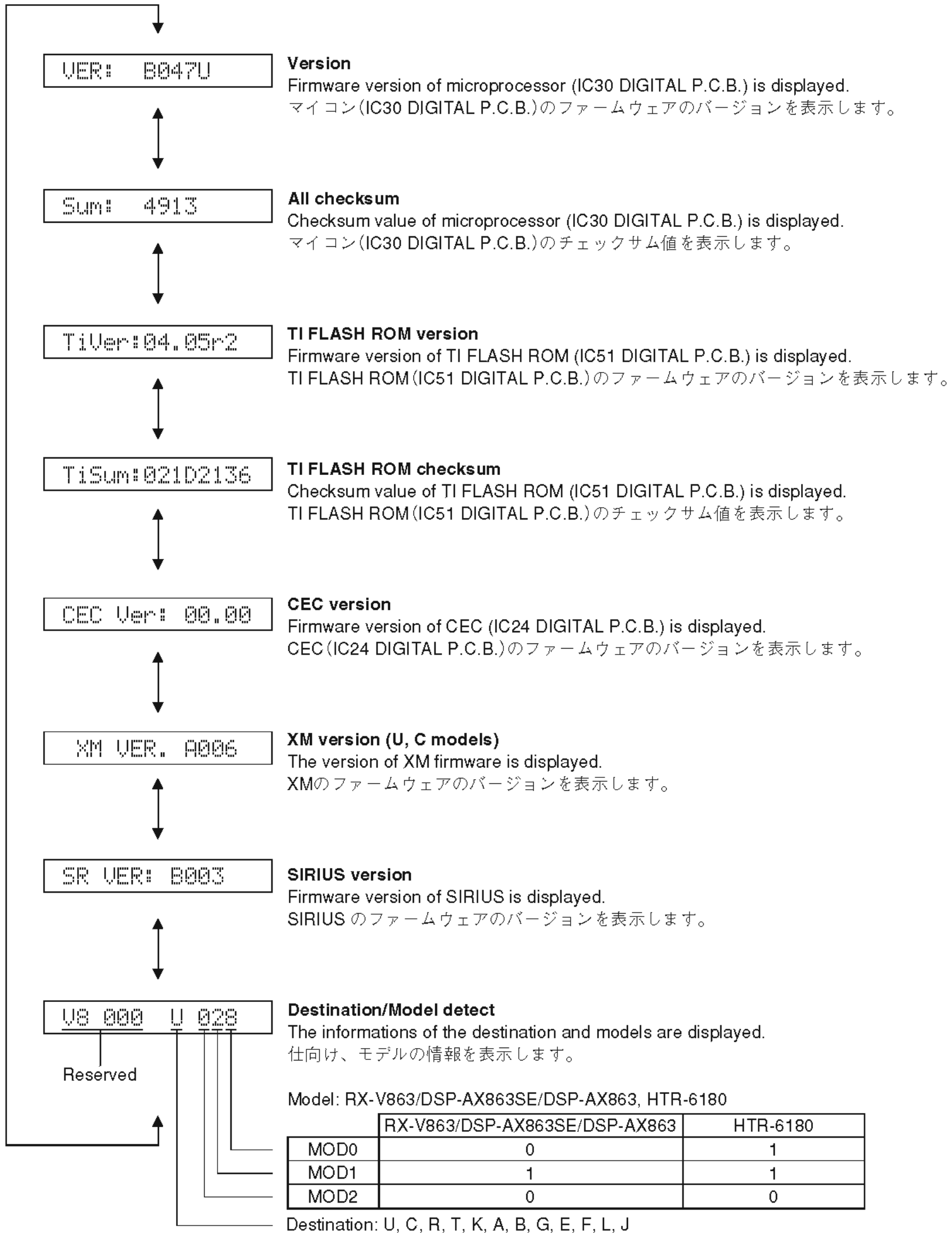

■ CONFIRMATION OF IDLING CURRENT OF AMP UNIT / アンプユニットのアイドリング電流の確認

- Right after power is turned on, confirm that the voltage across the terminals of R1303 (SURROUND BACK R ch), R1153 (SURROUND R ch), R1154 (FRONT R ch), R1152 (CENTER), R1150 (FRONT L ch), R1151 (SURROUND L ch), R1149 (SURROUND BACK L ch) are between 0.1 mV and 10.0 mV.
- If measured voltage exceeds 10.0 mV, open (cut off) R1252 (SURROUND BACK R ch), R1112 (SURROUND R ch), R1114 (FRONT R ch), R1110 (CENTER), R1106 (FRONT L ch), R1108 (SURROUND L ch), R1104 (SURROUND BACK L ch) and reconfirm the voltage.

Attention

If the measured voltage exceeds 10.0 mV after repairing a power amplifier first check for a defective component before cutting the bias resistor.

- Confirm that the voltage is 0.2 mV to 15.0 mV after 60 minutes.

- 電源投入直後、R1303 (SURROUND BACK R ch)、R1153 (SURROUND R ch)、R1154 (FRONT R ch)、R1152 (CENTER)、R1150 (FRONT L ch)、R1151 (SURROUND L ch)、R1149 (SURROUND BACK L ch)の端子間電圧を測定し、0.1 mVから10.0 mVの間であることを確認してください。
- 電圧が10.0 mVを超えている場合は、R1252 (SURROUND BACK R ch)、R1112 (SURROUND R ch)、R1114 (FRONT R ch)、R1110 (CENTER)、R1106 (FRONT L ch)、R1108 (SURROUND L ch)、R1104 (SURROUND BACK L ch)をカットし、電圧を再確認してください。

注意

パワーアンプ修理後に10.0 mVを超えている場合は、抵抗をカットする前に故障箇所を調べてください。

- 60分後、電圧が0.2 mV～15.0 mVであることを確認してください。

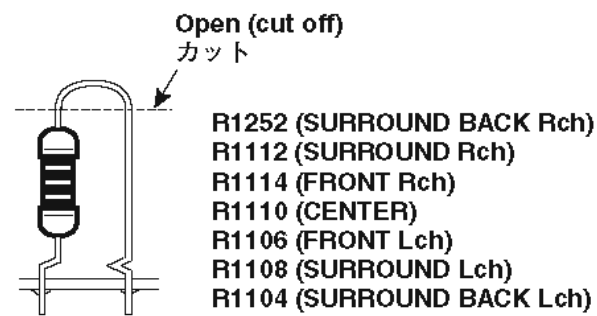
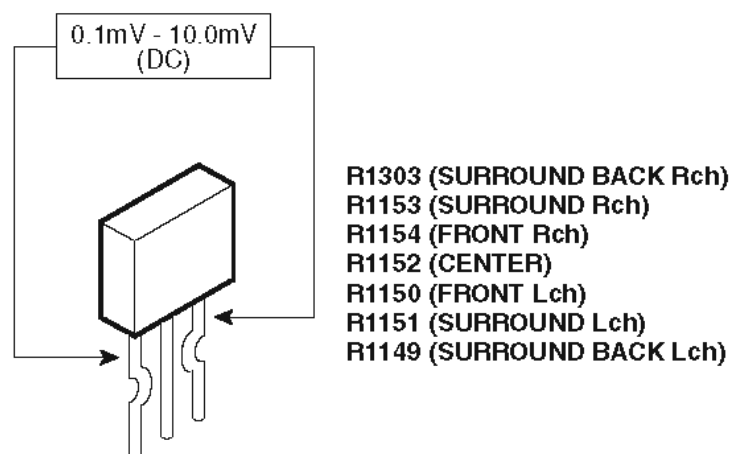

Rear

Top view

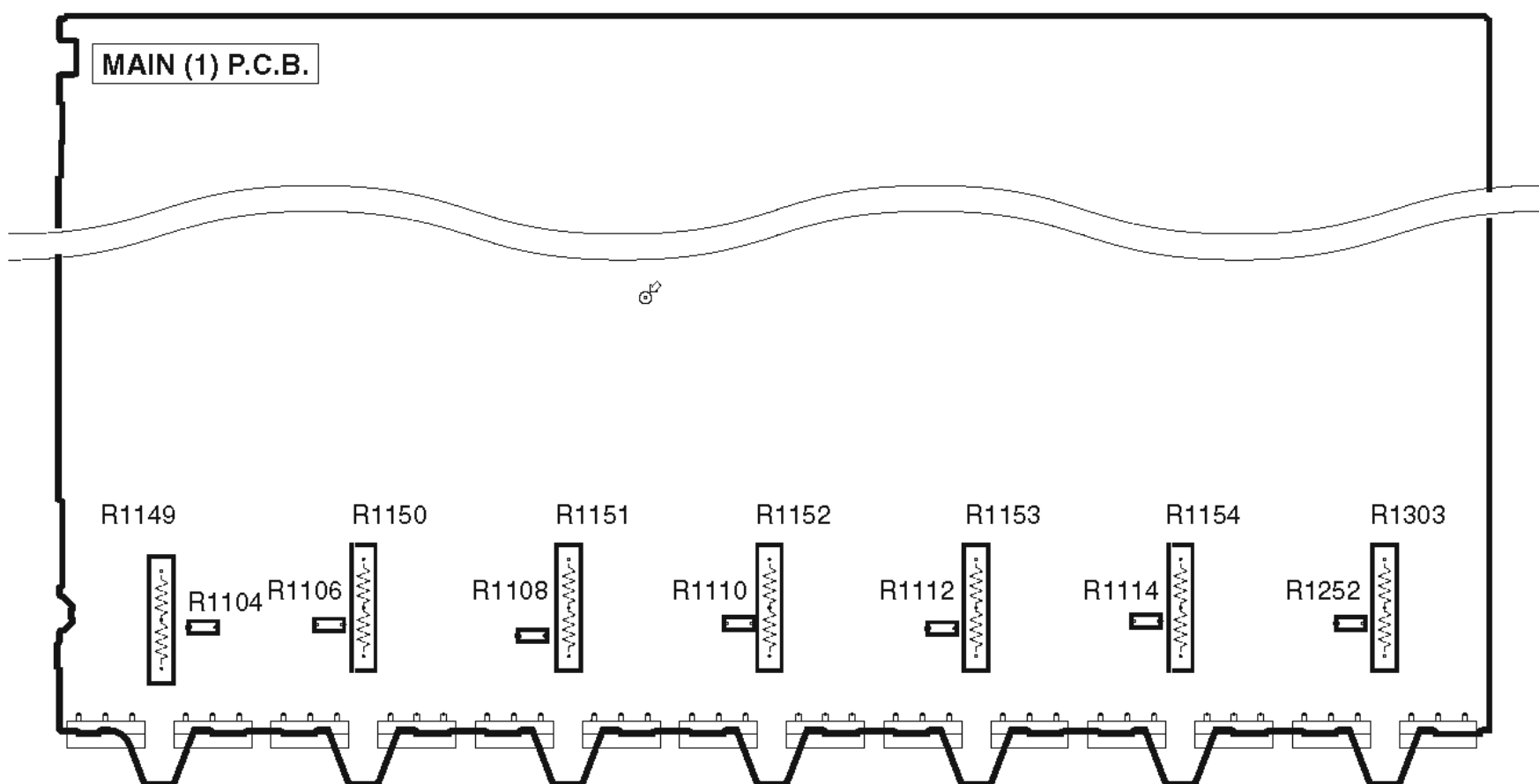

Front

■ DISPLAY DATA

● V401: 17-BT-32GNK (OPERATION P.C.B.)



● PIN CONNECTION

Pin No.	69	68	67	66	65	64	63	62	61	60	59	58	57	56	55	54	53	52	51	50	49	48	47	46	45	44	43	42	41	40	39	38	37	36	35	
Connection	F2	NX	NX	NX	NX	NX	NX	NX	NX	NX	NX	NX	NX	NX	NX	NX	NX	NX	NX	NX	NX	NX	NX	NX	NX	NX	NX	NX	NX	NX	NX	NX	NX	NX	NX	NX
Pin No.	34	33	32	31	30	29	28	27	26	25	24	23	22	21	20	19	18	17	16	15	14	13	12	11	10	9	8	7	6	5	4	3	2	1		
Connection	P32	P33	P34	P35	P36	P37	NX	NX	NX	NX	NX	NX	NX	NX	NX	17G	16G	15G	14G	13G	12G	11G	10G	9G	8G	7G	6G	5G	4G	3G	2G	1G	NP	NX	F1	

Note : 1) F1, F2 Filament pin 2) NP No pin 3) NX No extend pin 4) 1G~17G Grid pin

● GRID ASSIGNMENT

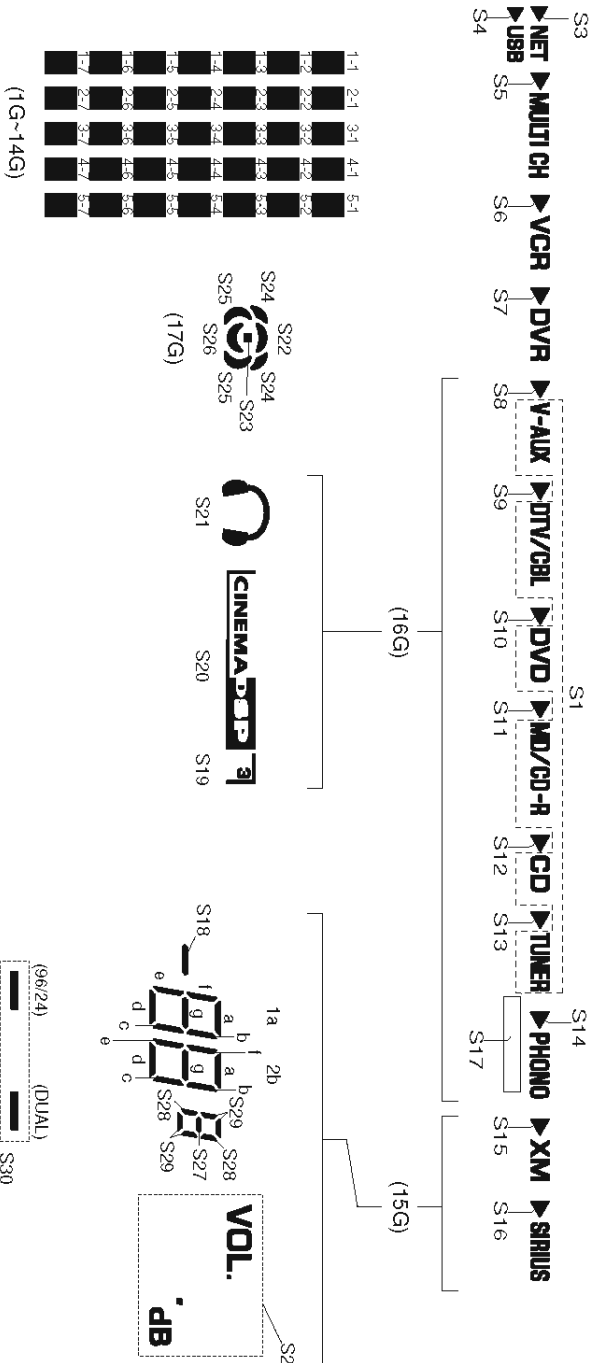
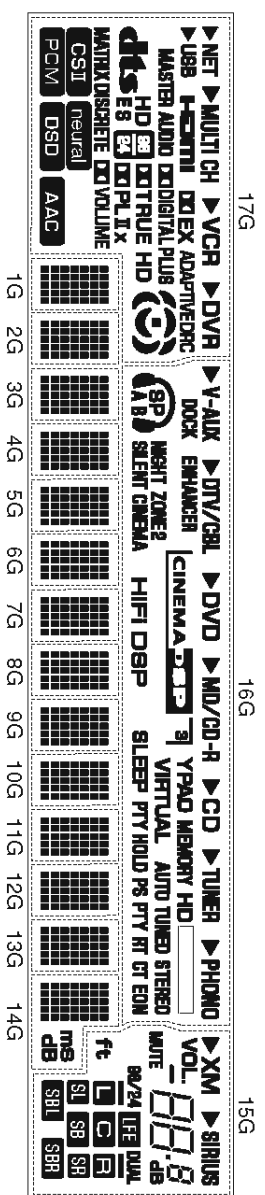

● ANODE CONNECTION

	17G	16G	15G	14G	13G~1G
1P	NET	S1	XM	1-1	1-1
2P	MULTI CH	PHONO	SIRIUS	2-1	2-1
3P	VCR	S8	S15	3-1	3-1
4P	DVR	S9	S16	4-1	4-1
5P	USB	S10	S2	5-1	5-1
6P	S3	S11	S18	1-2	1-2
7P	S5	S12	1a	2-2	2-2
8P	S6	S13	1b	3-2	3-2
9P	S7	S14	1c	4-2	4-2
10P	S4	DOCK	1d	5-2	5-2
11P	H-DCIM	ENHANCER	1e	1-3	1-3
12P	DIEX	S21	1f	2-3	2-3
13P	ADAPTEDRG	BP	1g	3-3	3-3
14P	MASTER AUDIO	A	2a	4-3	4-3
15P	dts	B	2b	5-3	5-3
16P	HD (ES)	NIGHT	2c	1-4	1-4
17P	ES	ZONE2	2d	2-4	2-4
18P	ES	SILENT CINEMA	2e	3-4	3-4
19P	DDIGITAL	S20	2f	4-4	4-4
20P	PLUS	S19	2g	5-4	5-4
21P	DOTRUE HD	HIFI DSP	S27	1-5	1-5
22P	DIPL	YPAO	S28	2-5	2-5
23P	I	MEMORY	S29	3-5	3-5
24P	x	HD	MUTE	4-5	4-5
25P	MATRIX	S17	BI/24	5-5	5-5
26P	DISCRETE	VIRTUAL	DUAL	1-6	1-6
27P	DI VOLUME	AUTO	ft	2-6	2-6
28P	CSTI	TUNED	S30	3-6	3-6
29P	(neutral)	STEREO	LFE	4-6	4-6
30P	PCM	SLEEP	L	5-6	5-6
31P	DSD	PTY (HOLD)	C	1-7	1-7
32P	AAC	HOLD	F	2-7	2-7
33P	S22	PS	SL	3-7	3-7
34P	S23	PTY (RT)	SB	4-7	4-7
35P	S24	RT	SR	5-7	5-7
36P	S25	GT	SBL	ms	-
37P	S26	EON	SBR	dB	-

■ IC DATA

IC41 : LC89057W-VF4AD-E (DIGITAL P.C.B.)
Digital audio interface transceiver

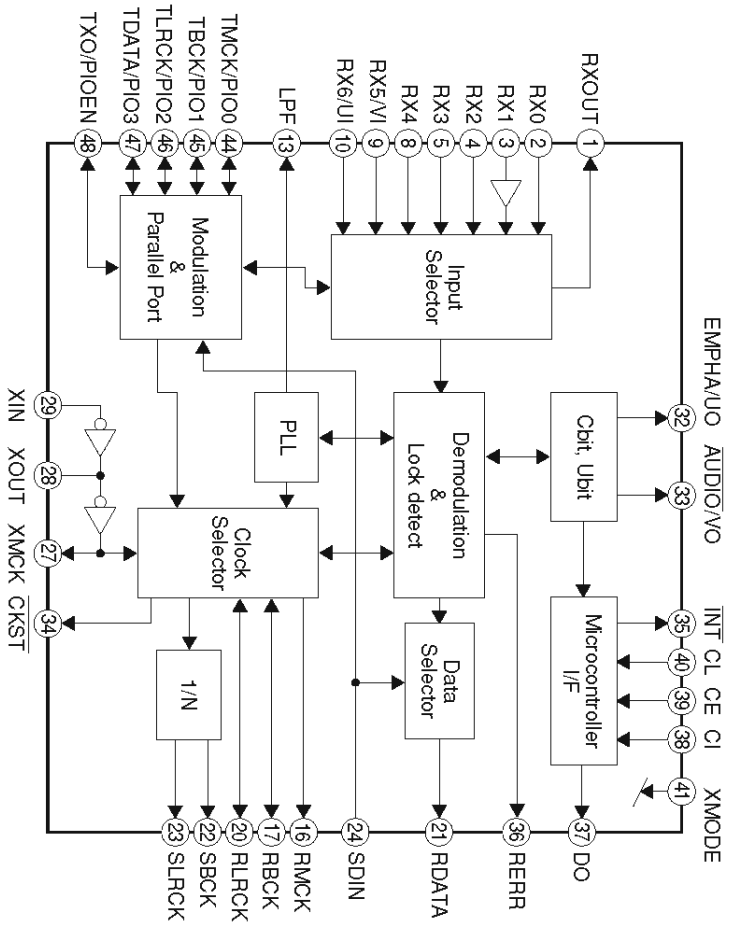

Pin No.	Function Name	I/O	Detail of Function
1	RXOUT	O	Output pin of input bi-phase selection data
2	RX0	Is	Input pin of TTL-compatible digital data
3	RX1	I	Digital data input pin with built-in amplifier that supports coaxial
4	RX2	Is	Input pin of TTL-compatible digital data
5	RX3	Is	Input pin of TTL-compatible digital data
6	DGND		Digital GND
7	DVDD		Digital power supply (3.3 V)
8	RX4	Is	Input pin of TTL-compatible digital data
9	RX5	Is	TTL-compatible digital data / Validity flag input pin for modulation
10	RX6	Is	TTL-compatible digital data / User data input pin for modulation
11	DVDD		Digital power supply for PLL
12	DGND		Digital GND for PLL
13	LPF	O	PLL loop filter connection pin
14	AVDD		Analog power supply for PLL (3.3 V)
15	AGND		Analog GND for PLL
16	RMCK	O	R system clock output pin (256 fs, 512 fs, XIN, VCO)
17	RBCK	O/I	R bit clock input/output pin (64 fs)
18	DGND		Digital GND
19	DVDD		Digital power supply (3.3 V)
20	RLRCK	O/I	R LR clock input/output pin (fs)
21	RDATA	O	Output pin of serial audio data
22	SBCK	O	S bit clock output pin (32 fs, 64 fs, 128 fs) (No connected.)
23	SLRCK	O	S LR clock output pin (fs/2, fs, 2 fs) (No connected.)
24	SDIN	Is	Input pin of serial audio data
25	DGND		Digital GND
26	DVDD		Digital power supply (3.3 V)
27	XMCK	O	Oscillation amplifier output pin
28	XOUT	O	Quartz resonator connection output pin
29	XIN	I	Quartz resonator connection, input pin of external supply clock (24.576 MHz or 12.288 MHz)
30	DVDD		Digital power supply (3.3 V)
31	DGND		Digital GND
32	EMPHA/UO/CD	I/O	Emphasis information / U data output / C data output / Chip address setting pin
33	AUDIO/VO	I/O	Non-PCM detection / V flag output / Chip address setting pin
34	CKST/PT	I/O	Output of clock switch transitional period signal / Preamble B output / Demodulation master or slave function switch pin
35	INT	I/O	Interrupt output for microprocessor (Possible to select an interrupt factor.) / Modulation or general-purpose I/O switch pin
36	RERR	O	PLL clock error, data error flag output
37	DO	O	Microprocessor I/F, read data output pin (3-state)
38	DI	Is	Microprocessor I/F, write data input pin
39	CE	Is	Microprocessor I/F, chip enable input pin
40	CL	Is	Microprocessor I/F, clock input pin ¹⁾
41	XMODE	Is	System reset input pin
42	DGND		Digital GND
43	DVDD		Digital power supply (3.3 V)
44	PIO0	I/O	512 fs, 256 fs, 128 fs system clock input for modulation or external / General-purpose I/O input/output pin
45	PIO1	I/O	64 fs bit clock input for modulation / General-purpose I/O input/output pin
46	PIO2	I/O	fs clock input for modulation / General-purpose I/O input/output pin
47	PIO3	I/O	Serial audio data input for modulation / General-purpose I/O input/output pin
48	PIOEN	I/O	Modulation data output / General-purpose I/O enable output pin

1) Withstand voltage input/output: I or O = -0.3 to 3.6 V, Is = -0.3 to 5.5 V

2) Pins 32 and 33 are input pins for chip address setting, when pin 41 = "L".

3) Pin 34 is a demodulation function master or an input pin for slave setting, when pin 41 = "L".

4) Pin 35 is a modulation function or an input pin for general-purpose I/O function switch setting, when pin 41 = "L".

5) ON/OFF for all power supplies must be done at the same timing as a latch-up countermeasure.

IC44 : D70YE101BRFP266 (DIGITAL P.C.B.)
 Floating-point digital signal processors

* No replacement part available. / サービス部品供給なし

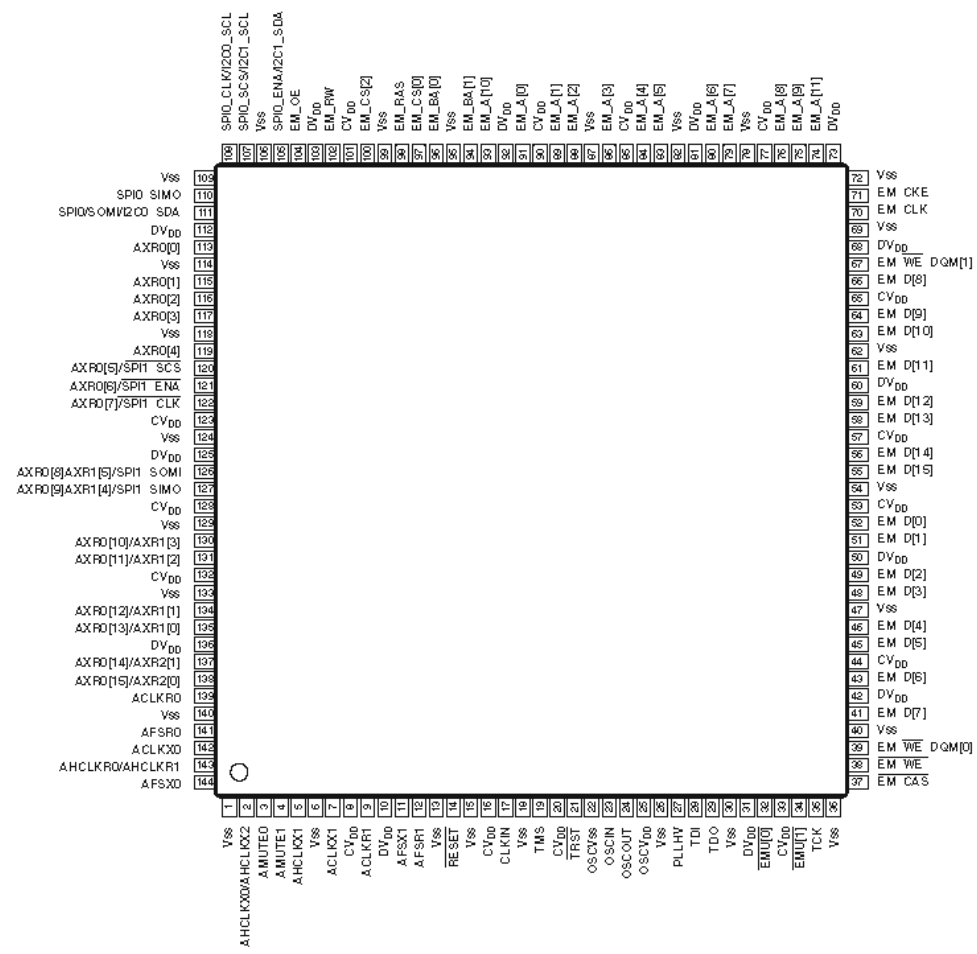
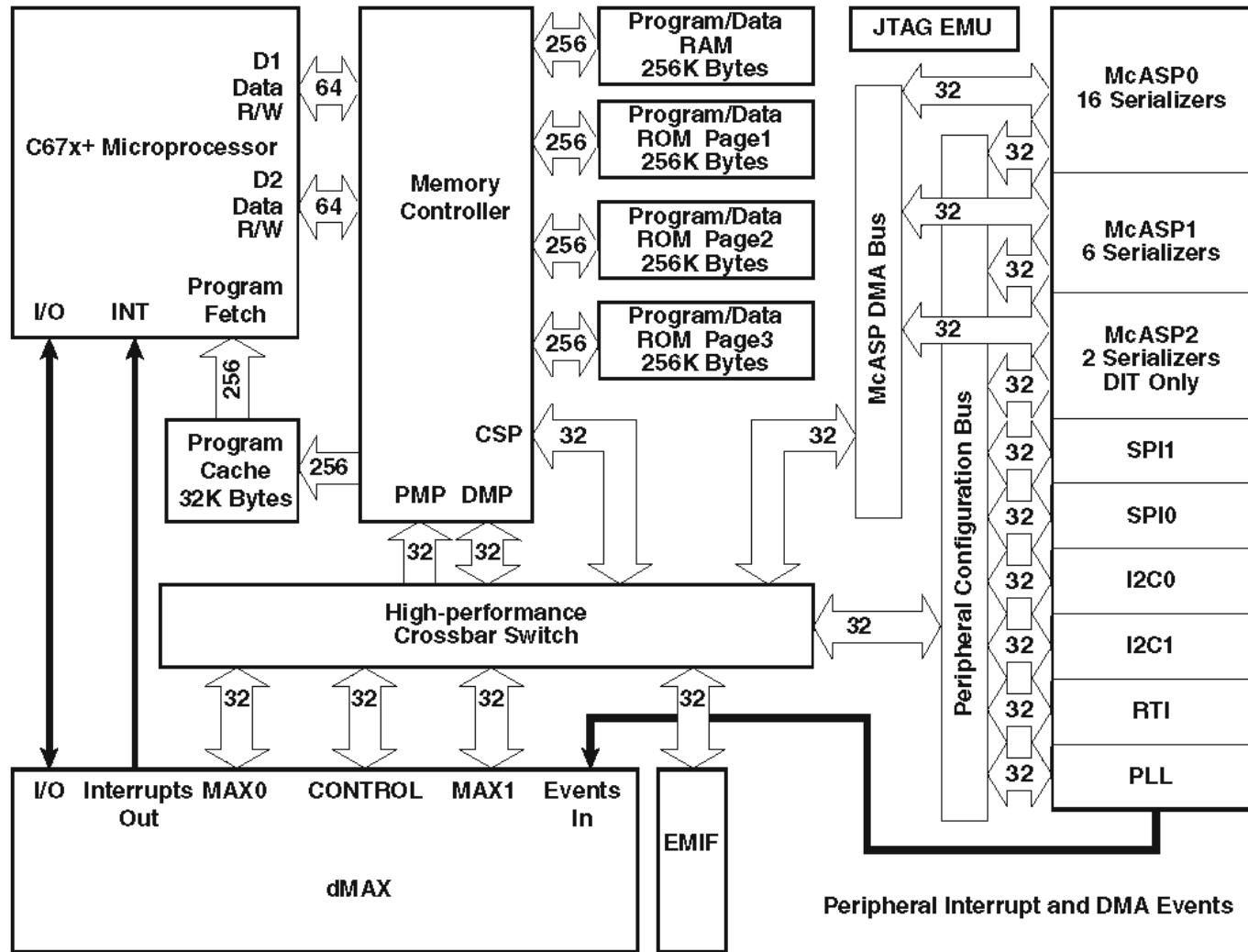

RX-V863/HTR-6180/DSP-AX863SE/
 DSP-AX863

Pin No.	Function Name	I/O			Detail of Function
		TYPE ⁽¹⁾	PULL ⁽²⁾	GPIO ⁽³⁾	
External memory interface (EMIF) address and control					
37	EM_CAS	O	-	N	SDRAM column address strobe
38	EM_WE	O	-	N	SDRAM write enable
39	EM_WE_DQM[0]	O	-	N	Write enable or byte enable for EM_D[7:0]
67	EM_WE_DQM[1]	O	-	N	Write enable or byte enable for EM_D[15:8]
70	EM_CLK	O	-	N	SDRAM clock
71	EM_CKE	O	-	N	SDRAM clock enable
74	EM_A[11]	O	-	N	EMIF address bus
75	EM_A[9]	O	-	N	
76	EM_A[8]	O	-	N	
79	EM_A[7]	O	-	N	
80	EM_A[6]	O	-	N	
83	EM_A[5]	O	-	N	
84	EM_A[4]	O	-	N	
86	EM_A[3]	O	-	N	
88	EM_A[2]	O	-	N	
89	EM_A[1]	O	-	N	
91	EM_A[0]	O	-	N	
93	EM_A[10]	O	-	N	
94	EM_BA[1]	O	-	N	
96	EM_BA[0]	O	-	N	
97	EM_CS[0]	O	-	N	SDRAM chip select
98	EM_RAS	O	-	N	SDRAM row address strobe
100	EM_CS[2]	O	-	N	Asynchronous memory chip select
102	EM_RW	O	-	N	Asynchronous memory read/not write (No connected.)
104	EM_OE	O	-	N	SDRAM output enable
External memory interface (EMIF) data bus					
41	EM_D[7]	I/O	-	N	EMIF data bus [Lower 16-bit]
43	EM_D[6]	I/O	-	N	
45	EM_D[5]	I/O	-	N	
46	EM_D[4]	I/O	-	N	
48	EM_D[3]	I/O	-	N	
49	EM_D[2]	I/O	-	N	
51	EM_D[1]	I/O	-	N	
52	EM_D[0]	I/O	-	N	
55	EM_D[15]	I/O	-	N	
56	EM_D[14]	I/O	-	N	
58	EM_D[13]	I/O	-	N	
59	EM_D[12]	I/O	-	N	
61	EM_D[11]	I/O	-	N	
63	EM_D[10]	I/O	-	N	
64	EM_D[9]	I/O	-	N	
66	EM_D[8]	I/O	-	N	
McASP0, McASP1, McASP2 and SPI1 serial ports					
2	AHCLKX0	I/O	-	Y	McASP0 and McASP2 transmit master clock
3	AMUTE0	O	-	Y	McASP0 mute output
4	AMUTE1	O	-	Y	McASP1 mute output
5	AHCLKX1	I/O	-	Y	McASP1 transmit master clock
7	ACLKX1	I/O	-	Y	McASP1 transmit bit clock
9	ACLKR1	I/O	-	Y	McASP1 receive bit clock
11	AFSX1	I/O	-	Y	McASP1 transmit frame sync (L/R clock)
12	AFSR1	I/O	-	Y	McASP1 receive frame sync (L/R clock)
113	AXR0[0]	I/O	-	Y	McASP0 serial data 0
115	AXR0[1]	I/O	-	Y	McASP0 serial data 1
116	AXR0[2]	I/O	-	Y	McASP0 serial data 2

Pin No.	Function Name	I/O			Detail of Function	
		TYPE ⁽¹⁾	PULL ⁽²⁾	GPIO ⁽³⁾		
117	AXR0[3]	I/O	–	Y	McASP0 serial data 3	
119	AXR0[4]	I/O	–	Y	McASP0 serial data 4	
120	SPI1_SCS	I/O	–	Y	McASP0 serial data 5 or SPI1 slave chip select	
121	SPI1_ENA	I/O	–	Y	McASP0 serial data 6 or SPI1 enable (Ready)	
122	SPI1_CLK	I/O	–	Y	McASP0 serial data 7 or SPI1 serial clock	
126	SPI1_SOMI	I/O	–	Y	McASP0 serial data 8 or McASP1 serial data 5 or SPI1 data pin slave out master in	
127	SPI1_SIMO	I/O	–	Y	McASP0 serial data 9 or McASP1 serial data 4 or SPI1 data pin slave in master out	
130	AXR0[10]	I/O	–	Y	McASP0 serial data 10 or McASP1 serial data 3	
131	AXR0[11]	I/O	–	Y	McASP0 serial data 11 or McASP1 serial data 2	
134	AXR0[12]	I/O	–	Y	McASP0 serial data 12 or McASP1 serial data 1	
135	AXR0[13]	I/O	–	Y	McASP0 serial data 13 or McASP1 serial data 0	
137	AXR0[14]	I/O	–	Y	McASP0 serial data 14 or McASP2 serial data 1	
138	AXR0[15]	I/O	–	Y	McASP0 serial data 15 or McASP2 serial data 0	
139	ACLKR0	I/O	–	Y	McASP0 receive bit clock	
141	AFSR0	I/O	–	Y	McASP0 receive frame sync (L/R clock)	
142	ACLKX0	I/O	–	Y	McASP0 transmit bit clock	
143	AHCLKR0/AHCLKR1	I/O	–	Y	McASP0 and McASP1 receive master clock	
144	AFSX0	I/O	–	Y	McASP0 transmit frame sync (L/R clock)	
SPI0, I2C0 and I2C1 serial port pins						
105	SPIO_ENA	I/O	–	Y	SPI0 enable (Ready) or I2C1 serial data	
107	SPIO_ENA	I/O	–	Y	SPI0 slave chip select or I2C1 serial clock	
108	SPIO_CLK	I/O	–	Y	SPI0 serial clock or I2C0 serial clock	
110	SPIO_SIMO	I/O	–	Y	SPI0 data pin slave in master out	
111	SPIO/SOMI	I/O	–	Y	SPI0 data pin slave out master in or I2C0 serial data	
Clocks						
17	CLKIN	I	–	N	Alternate clock input (3.3 V LVCMOS input)	
22	OSCVSS	PWR	–	N	oscillator Vss tap point (for filter only)	
23	OSCIN	I	–	N	1.2 V oscillator input	
24	OSCOU	O	–	N	1.2 V oscillator output (No connected.)	
25	OSCVDD	PWR	–	N	oscillator 1.2 V VDD tap point (for filter only)	
27	PLLHV	PWR	–	N	PLL 3.3 V supply input (requires external filter)	
Device reset						
14	RESET	I	–	N	Device reset pin	
Emulation/JTAG port						
19	TMS	I	IPU	N	Test mode select	
21	TRST	I	IPD	N	Test reset	
28	TDI	I	IPU	N	Test data in	
29	TDO	OZ	IPU	N	Test data out	
32	EMU[0]	I/O	IPU	N	Emulation pin 0	
34	EMU[1]	I/O	IPU	N	Emulation pin 1	
35	TCK	I	IPU	N	Test clock	
Power pins						
8	CVDD				Core supply	
16						
20						
33						
44						
53						
57						
65						
77						
85						
90						
101						
123						

Pin No.	Function Name	I/O			Detail of Function
		TYPE ⁽¹⁾	PULL ⁽²⁾	GPIO ⁽³⁾	
128	CVDD				Core supply
132					
10	DVDD				I/O supply
31					
42					
50					
60					
68					
73					
81					
92					
103					
112					
125					
136					
1		VSS			
6					
13					
15					
18					
26					
30					
36					
40					
47					
54					
62					
69					
72					
78					
82					
87					
95					
99					
106					
109					
114					
118					
124					
129					
133					
140					

- 1) TYPE column refers to pin direction in functional mode. If a pin has more than one function with different directions, the functions are separated with a slash (/).
- 2) PULL column:
 IPD = Internal Pull-down resistor
 IPU = Internal Pull-up resistor
- 3) If the GPIO column is 'Y', then in GPIO mode, the pin is configurable as an I/O unless otherwise marked.

IC202 : R2A15218FP (FUNCTION P.C.B.)
8 ch electronic volume with 11 input selector and tone control

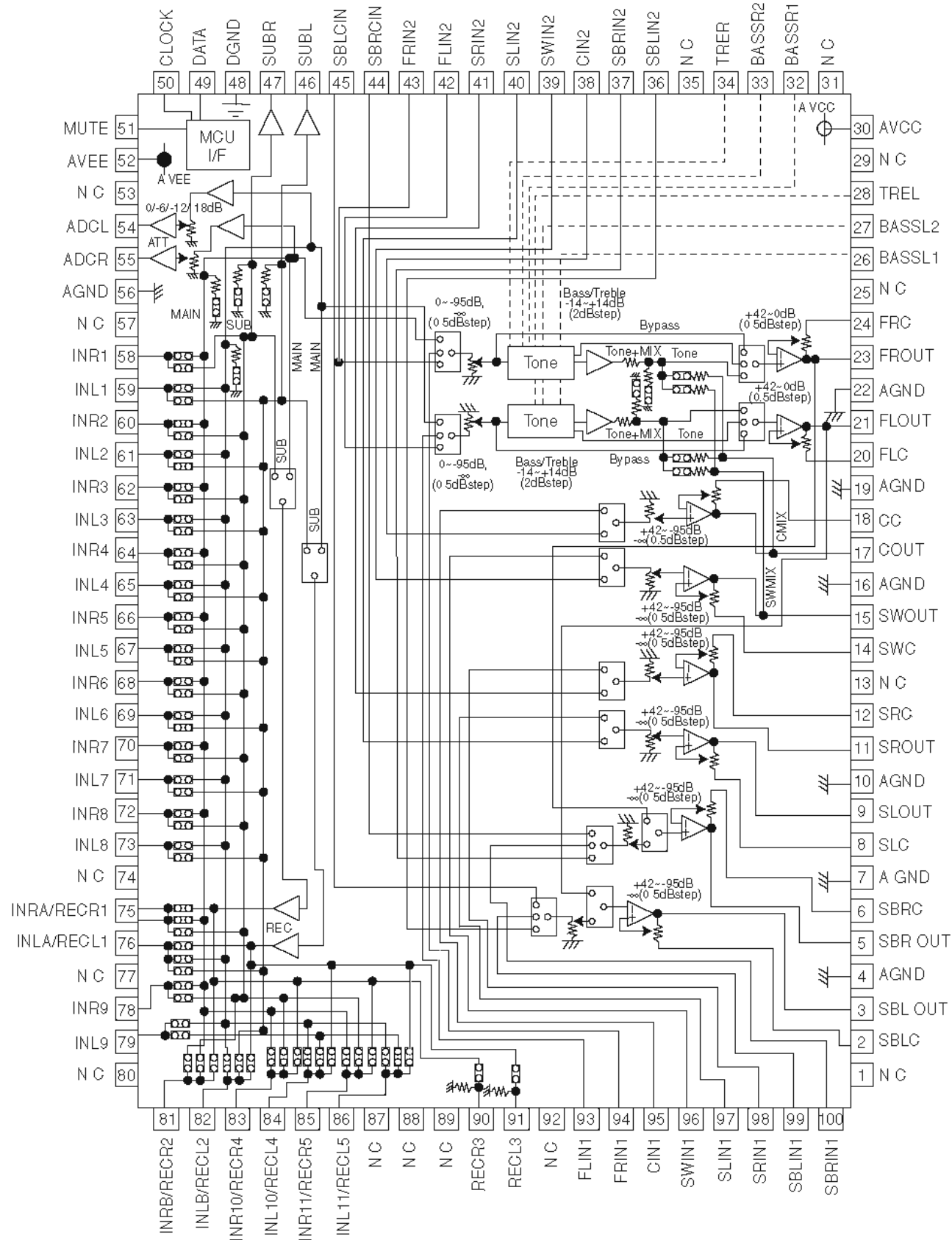

Pin No.	Function Name	Detail of Function
1	NC	
2	SBLC	Connects capacitor for reducing click noise of L/R/C/SW/SL/SR/SBL/SBR channel volume
3	SBL OUT	Output pin of FL/FR/C/SW/SL/SR/SBL/SBR channel
4	AGND	Analog ground of internal circuit
5	SBR OUT	Output pin of FL/FR/C/SW/SL/SR/SBL/SBR channel
6	SBRC	Connects capacitor for reducing click noise of L/R/C/SW/SL/SR/SBL/SBR channel volume
7	AGND	Analog ground of internal circuit
8	SLC	Connects capacitor for reducing click noise of L/R/C/SW/SL/SR/SBL/SBR channel volume
9	SLOUT	Output pin of FL/FR/C/SW/SL/SR/SBL/SBR channel
10	AGND	Analog ground of internal circuit
11	SROUT	Output pin of FL/FR/C/SW/SL/SR/SBL/SBR channel
12	SRC	Connects capacitor for reducing click noise of L/R/C/SW/SL/SR/SBL/SBR channel volume
13	NC	
14	SWC	Connects capacitor for reducing click noise of L/R/C/SW/SL/SR/SBL/SBR channel volume
15	SWOUT	Output pin of FL/FR/C/SW/SL/SR/SBL/SBR channel
16	AGND	Analog ground of internal circuit
17	COUT	Output pin of FL/FR/C/SW/SL/SR/SBL/SBR channel
18	CC	Connects capacitor for reducing click noise of L/R/C/SW/SL/SR/SBL/SBR channel volume
19	AGND	Analog ground of internal circuit
20	FLC	Connects capacitor for reducing click noise of L/R/C/SW/SL/SR/SBL/SBR channel volume
21	FLOUT	Output pin of FL/FR/C/SW/SL/SR/SBL/SBR channel
22	AGND	Analog ground of internal circuit
23	FROUT	Output pin of FL/FR/C/SW/SL/SR/SBL/SBR channel
24	FRC	Connects capacitor for reducing click noise of L/R/C/SW/SL/SR/SBL/SBR channel volume
25	NC	
26	BASSL1	Frequency characteristic setting pin of L/R channel tone control (Bass)
27	BASSL2	
28	TREL	Frequency characteristic setting pin of L/R channel tone control (Treble)
29	NC	
30	AVCC	Positive power supply to internal circuit
31	NC	
32	BASSR1	Frequency characteristic setting pin of L/R channel tone control (Bass)
33	BASSR2	
34	TRER	Frequency characteristic setting pin of L/R channel tone control (Treble)
35	NC	
36	SBLIN2	Input pin of L/R/C/SW/SL/SR/SBL/SBR channel (Multi IN 1/2)
37	SBRIN2	
38	CIN2	
39	SWIN2	
40	SLIN2	
41	SRIN2	
42	FLIN2	
43	FRIN2	
44	SBRCIN	Input pin for SBL/SBR channel volume
45	SBLCIN	
46	SUBL	Output pin for L/R channel SUB output
47	SUBR	
48	DGND	Digital ground of internal circuit
49	DATA	Input pin of control data
50	CLOCK	Input pin of control clock

RX-V863/HTR-6180/DSP-AX863SE/
DSP-AX863

Pin No.	Function Name	Detail of Function
51	MUTE	Outside mute control pin
52	AVEE	Negative power supply to internal circuit
53	NC	
54	ADCL	Output pin for L/R channel ADC
55	ADCR	
56	AGND	Analog ground of internal circuit
57	NC	
58	INR1	Input pin of L/R channel (Input selector)
59	INL1	
60	INR2	
61	INL2	
62	INR3	
63	INL3	
64	INR4	
65	INL4	
66	INR5	
67	INL5	
68	INR6	
69	INL6	
70	INR7	
71	INL7	
72	INR8	
73	INL8	
74	NC	
75	INRA/RECR1	Input pin of L/R channel (Input selector) / Output pin for L/R channel REC output
76	INLA/RECL1	
77	NC	
78	INR9	Input pin of L/R channel (Input selector)
79	INL9	
80	NC	
81	INRB/RECR2	Input pin of L/R channel (Input selector) / Output pin for L/R channel REC output
82	INLB/RECL2	
83	INR10/RECR4	
84	INL10/RECL4	
85	INR11/RECR5	
86	INL11/RECL5	
87	NC	
88	NC	
89	NC	
90	RECR3	Output pin for L/R channel REC output
91	RECL3	
92	NC	
93	FLIN1	Input pin of L/R/C/SW/SL/SR/SBL/SBR channel (Multi IN 1/2)
94	FRIN1	
95	CIN1	
96	SWIN1	
97	SLIN1	
98	SRIN1	
99	SBLIN1	
100	SBRIN1	

IC401 : M66003-0131FP (OPERATION P.C.B.)
FL display driver

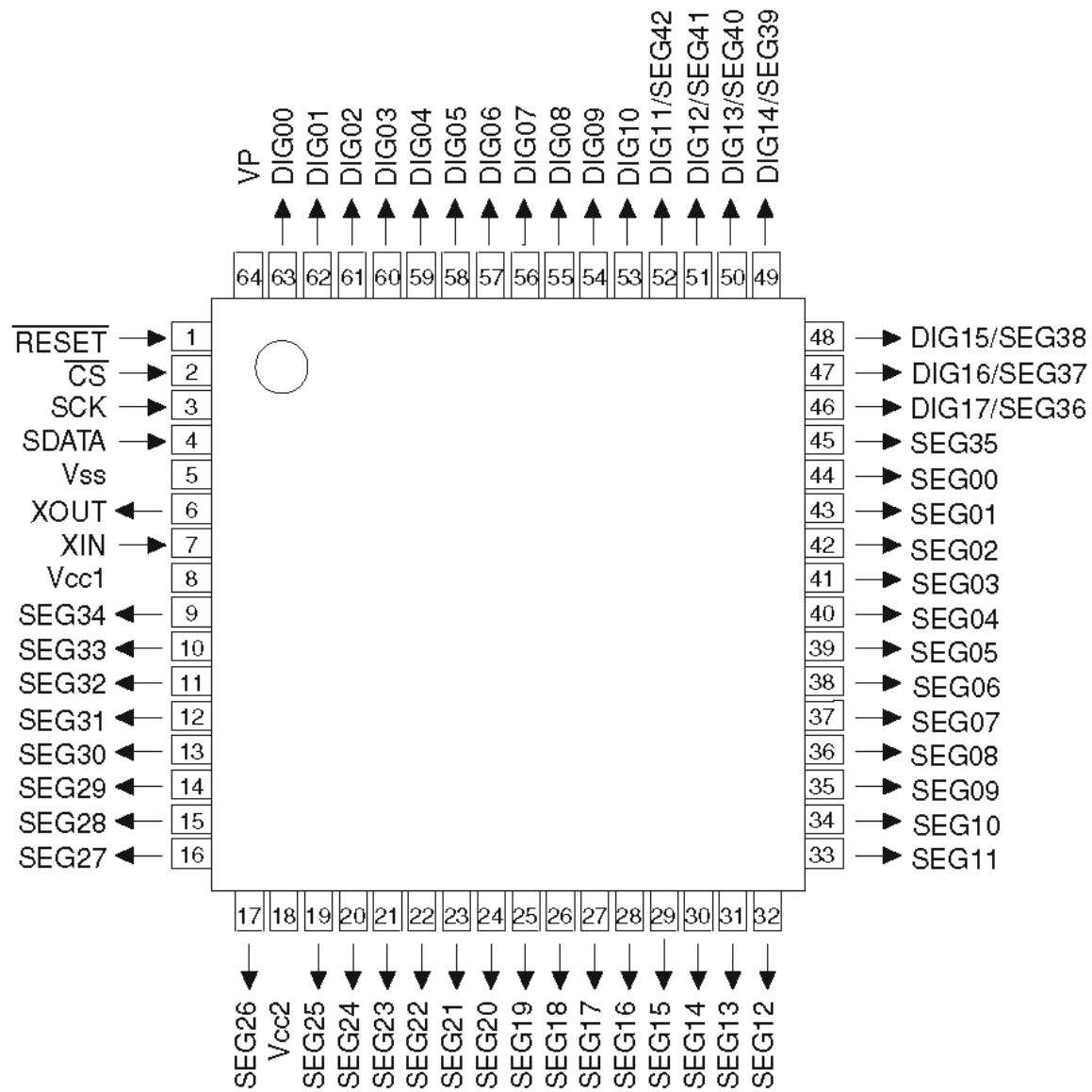
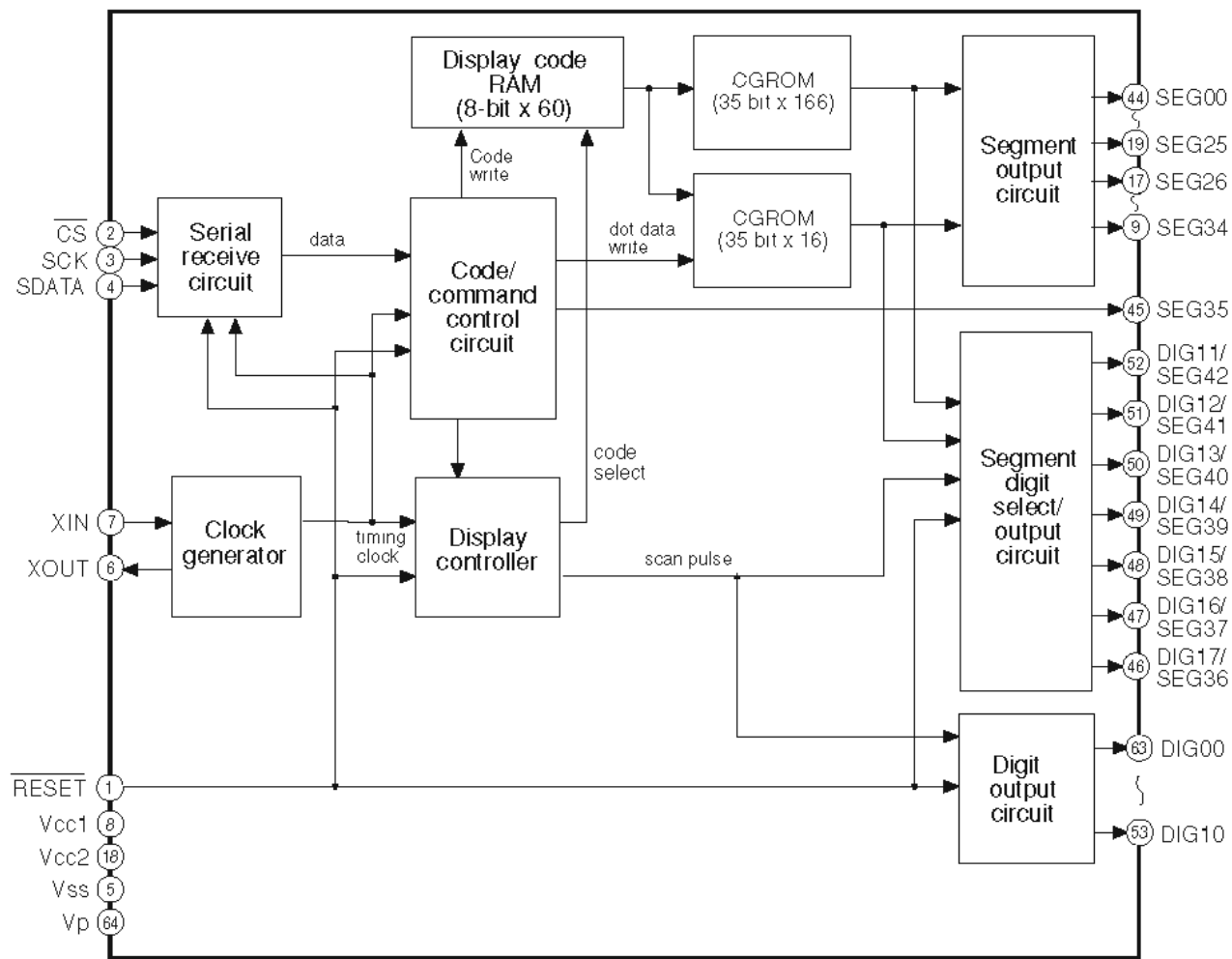

Pin No.	Port Name	Function Name	I/O	Detail of Function
1	RESET	/RESET	Reset input	When "L", M66003 is initialized.
2	CS	/CEFL	Chip select input	When "L", communication with the MCU is possible.
3	SCK	CKFL	Shift clock input	When "H", any instruction from the MCU is neglected.
4	SDATA	DTFL	Serial data input	Serial input data is taken and shifted by the positive edge of SCK.
5	Vss	VSS		GND (0V)
6	XOUT	XOUT	Clock out	When use as a CR oscillator, connect external resistor and capacitor. When use an external clock input external dock to XIN, and XOUT must be opened.
7	XIN	XIN	Clock in	
8	Vcc1	VDD		Positive power supply for internal logic.
9	SEG34	P11	Segment output	Connect to segment (anode) pins of VFD.
10	SEG33	P2		
11	SEG32	P3		
12	SEG31	P4		
13	SEG30	P5		
14	SEG29	P6		
15	SEG28	P7		
16	SEG27	P8		
17	SEG26	P9		
18	Vcc2	VDD		Positive power supply for DIG and SEG outputs.
19	SEG25	P10	Segment output	Connect to segment (anode) pins of VFD.
20	SEG24	P11		
21	SEG23	P12		
22	SEG22	P13		
23	SEG21	P14		
24	SEG20	P15		
25	SEG19	P16		
26	SEG18	P17		
27	SEG17	P18I		
28	SEG16	P19		
29	SEG15	P20		
30	SEG14	P21		
31	SEG13	P22		
32	SEG12	P23		
33	SEG11	P24		
34	SEG10	P25		
35	SEG09	P26		
36	SEG08	P27		
37	SEG07	P28		
38	SEG06	P29		
39	SEG05	P30		
40	SEG04	P31		
41	SEG03	P32		
42	SEG02	P33		
43	SEG01	P34		
44	SEG00	P35		
45	SEG35	P36		
46	SEG36	P37		
47	DIG16/SEG37	G17I	Digital output	Connect to digit (grid) pins of VFD.
48	DIG15/SEG38	G16I		
49	DIG14/SEG39	G15I		
50	DIG13/SEG40	G14		
51	DIG12/SEG41	G13		
52	DIG11/SEG42	G12		
53	DIG10	G11		
54	DIG09	G10		
55	DIG08	G9		
56	DIG07	G8		
57	DIG06	G7		
58	DIG05	G6		
59	DIG04	G5		
60	DIG03	G4		
61	DIG02	G3		
62	DIG01	G2		
63	DIG00	G1		
64	VP	VP		Negative power supply to pull down.

IC30 : M30878FJBGP (DIGITAL P.C.B.)
Single chip 16/32-bit microprocessor

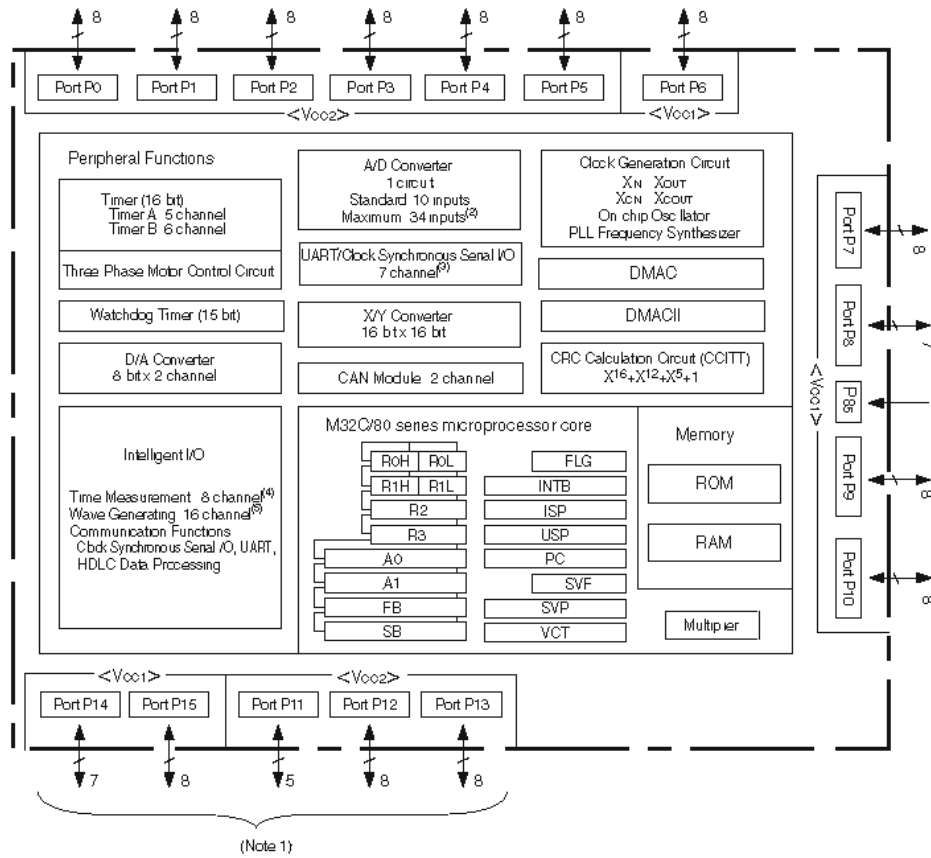

- (Note 1)
- NOTES
- 1 Ports P11 to P15 are provided in the 144 pin package only
 - 2 Included in the 144 pin package only 26 inputs maximum in the 100 pin package
 - 3 6 channel available in the 100 pin package
 - 4 6 channel available in the 100 pin package
 - 5 10 channel available in the 100 pin package

M30878FJBGP			
144	RxDi	72	CPNTD
143	AVcc	71	/MTMON
142	VREF	70	/MTVR2
141	iPAP	69	/MTVR1
140	AVss	68	/OSDCE(MOD2)
139	DEST	67	/ICV
138	THM	66	SVDET
137	VPWR	65	BYPASS(/CE)
136	PRV2	64	VIC
135	PRV1	63	VIB
134	ADKEY1	62	VIA
133	ADKEY0	61	/HP
132	Vcc	60	DPWR
131	SDTN	59	Vcc2
130	Vss	58	/ICS
129	SCKN	57	Vss
128	DKID	56	/AUPH
127	SRPWR	55	/AUPH_A
126	PRD	54	/INTH_RT(/EPM)
125	PLDET	53	/RES_Tx
124	/MIC	52	/RES_Rx
123	DKPWR	51	RMSCN
122	/CEFD(MOD0)	50	/PSENB
121	SCEN2	49	RMSCNCK
120	SCEN1	48	/HSW_RST(&RST_C)
119	SCEN0	47	/AUP_MT
118	TXDSR	46	/232SD
117	VRB	45	SCLH
116	RXDSR	44	SDAH
115	VRA	43	CTS/BUSY
114	TONEB	42	RTS/CLKF
113	TONEA	41	Vss
112	ISB	40	RXDR
111	ISA	39	Vcc1
110	/ASTFD	38	TXDR
109	PDLED	37	SDAL
108	TRIG		
107	SP_IMP		
106	SPA		
105	SPB		
104	REM		
103	/PSW		
102	PDET		
101	SPC		
100	SBRY		
99	Z2RY		
98	PR1		
97	PRY		
96	PSV		
95	/ST		
94	/TUNED		
93	Vss		
92	TMT		
91	Vcc2		
90	SDTP		
89	SCKP		
88	SDRP		
87	CEP(MOD1)		
86	DTEX		
85	CKEX		
84	/MTZ2		
83	/MTFS		
82	/MTSB		
81	/MTSW		
80	/MTCT		
79	/MTHP		
78	DTEV		
77	CKEY		
76	Vss		
75	LSEL1		
74	Vcc2		
73	LSEL0		
72			
71			
70			
69			
68			
67			
66			
65			
64			
63			
62			
61			
60			
59			
58			
57			
56			
55			
54			
53			
52			
51			
50			
49			
48			
47			
46			
45			
44			
43			
42			
41			
40			
39			
38			
37			
36			
35			
34			
33			
32			
31			
30			
29			
28			
27			
26			
25			
24			
23			
22			
21			
20			
19			
18			
17			
16			
15			
14			
13			
12			
11			
10			
9			
8			
7			
6			
5			
4			
3			
2			
1			

Pin No.	Port Name	Function Name (P.C.B.)	I/O							Detail of Function
			Power ON	VPWR OFF	STBY Thrh	STBY CEC	232C ON [232C OFF]	STANDBY [STBY Sleep]	MCU Sleep [Sleep]	
1	TXD4	TXDi	SO		O			O	O	Asynchronous data output for iPod
2	P95	XMPWR	O		O			O	O	Power control output for XM antenna H: ON, L: OFF (U, C models)
3	DA1	LC	DA		DA			I	I	Limiter control output
4	TB3in	iPDET	TMR						O	iPod loaded in DOCK detect Low when iPod is in Dock Stop mode (MCU sleep) when set to event counter
5	TXD3	DTXM	SO		O			O	[O]	Asynchronous data output for XM/DT IC (U, C models)
	P92	RDYRDS	I		I			O	[O]	READY input for RDS IC (G model)
6	RXD3	DRXM	SI		I			O	[O]	Asynchronous data input for XM/DT IC (U, C models)
		RXDRDS	SI		I			O	O	Synchronous data input for RDS IC (G model)
7	P90	XMLINK	I		O			O	O	LINK ACTIVE input for XM/DT IC (U, C models)
	CLK3	CLKRDS	SO		O			O	O	Synchronous clock output for RDS IC (G model) Setting to Low level standby required
8	INT8	RXDR	IRQ						O	RS-232C reception detect (U, C models) Used for return trigger from stop mode (MCU sleep) / Connect to 40pin
9	P145	/ICXM	O		O			O	[O]	Reset output for XM/DT IC (U, C models)
		RSTRDS	O		O			O	[O]	Reset output for RDS IC (G model)
10	P144	XMREV	I		O			O	O	ANT_REV input for XM/DT IC High: Non-compatible antenna
		DIRSDO	I		O			O	(O)	DIR DATA input for CDDA writing
11	P143	/ICADC	O		O			O	O	AD converter power down
12	P142	/ICDIR	O		O			O	O	Initial clear output for DIR
13	P141	/CSDIR	CS		O			O	O	Chip select output for DIR
14	P140	/ICTI	O		O			O	O	Initial clear output for TI (DA70Y)
15	BYTE	BYTE	MCU		MCU			MCU	MCU	When set to single chip mode: Vss
16	CNVss	CNVss	MCU		MCU			MCU	MCU	Processor mode select Low: Single chip mode High: To Flash included boot mode To boot mode with hardware resetting of P50=H, P55=L, CNVss=H
17	P87	/CSTI	CS		O			O	O	Chip select output for TI (DA70Y)
18	P86	/CSDAC	CS		O			O	O	Chip select output for DAC (for both 2ch/8ch)
19	RESET	/RESET	MCU		MCU			MCU	MCU	Reset
20	Xout	Xout	MCU		MCU			MCU	MCU	
21	Vss	Vss	MCU		MCU			MCU	MCU	
22	Xin	Xin	MCU		MCU			MCU	MCU	
23	Vcc1	Vcc	MCU		MCU			MCU	MCU	
24	NMI	/NMI	MCU		I				I	Unused, connect to Vcc
25	INT2	/INTDIR	IRQ		O			O	O	Interrupt input for DIR
26	INT1	/INTTI	IRQ		O			O	O	Interrupt input for TI (DA70Y)
27	INT0	/HSW_INT	IRQ		IRQ	IRQ		O	O	MATSUSHITA CEC microprocessor (13 pins) interrupt input
28	P81	/SPIRDY	I		O			O	O	READY input for TI (DA70Y)
		RWCK	I		O			O	[O]	DIR WCK input for CDDA writing
29	RXD5	SDD	SI		O			O	O	Synchronous data input for DIR, TI (DA70Y), DAC DIR: 4M, LSBF TI: 1M, MSBF
30	CLK5	SCK	SO		O			O	O	Synchronous clock output for DIR, TI (DA70Y), DAC
31	TXD5	SDM	SO		O			O	O	Synchronous data output for DIR, TI (DA70Y), DAC DIR: 4M, LSBF TI: 1M, MSBF
32	TA2in	HDMIMT	TMR		TMR			O	O	MDMI AUDIO MUTE input H: Mute
33	P74	MUTETI	O		O			O	O	Mute output (High=MUTE) for TI (DA70Y)
34	P73	CDMODE	O		O			O	O	CDDA write mote control output H: CDDA write mode L: Normal operation mote
35	P72	HSW_CEC	I		I	I		O	O	MATSUSHITA CEC microprocessor (12 pins) interrupt input Reset request from MATSUSHITA microprocessor

Pin No.	Port Name	Function Name (P.C.B.)	I/O							Detail of Function	
			Power ON	VPWR OFF	STBY Thrh	STBY CEC	232C ON [232C OFF]	STANDBY [STBY Sleep]	MCU Sleep [Sleep]		
36	SCL2	SCLL	SIO		SIO	SIO			O	O	I2C clock input/output for HDMI switcher & video switch (100kHz device) Pull up at HDMI block
37	SDA2	SDAL	SIO		SIO	SIO			O	O	I2C clock input/output for HDMI switcher & video switch (100kHz device) Pull up at HDMI block
38	TxD1	TXDR						SO [O]		O	RS-232C asynchronous communication data output
		TXDF									Data output for AF220
39	Vcc1	Vcc	MCU		MCU				MCU	MCU	Power source of microprocessor +5BU
40	RxD1	RXDR						SI [O]		O	RS-232C asynchronous communication data input Pull Down by 100k-ohms
		RXDF	SI								Data input for AF220
41	Vss	Vss	MCU		MCU				MCU	MCU	Ground of microprocessor
42	P65	RTS						O [O]		O	RS-232C asynchronous communication RTS output
	CLK1	CLKF	SI								Clock input for AF220
43	CTS1	CTS						SI [O]		O	RS-232C asynchronous communication CTS input Pull Down by 100k-ohms
	RTS1	BUSY	SO								BUSY output for AF220
44	SDA0	SDAH	SIO		SIO				O	O	HDMI-RX/TX, VIDEO-DEC/ENG I2C clock input/output (400kHz device) Pull up at HDMI block / HDMI Rx,Tx: 5V tolerant
45	SCL0	SCLH	SIO		SIO				O	O	HDMI-RX/TX, VIDEO-DEC/ENG I2C data input/output (400kHz device) Pull up at HDMI block / HDMI Rx,Tx: 5V tolerant
46	P61	/232SD						O [O]		O	232C driver shut-down control L: Shut down Default High (232C ON) for U, C model Default Low for other than U, C model
47	P60	/AUP_MT	O		O				O	O	Audio Up conversion Mute output L: Mute Muted even when audio up conversion is not executed
48	P137	/HSW_RST	O		O	O			O	O	Reset output for HDMI switcher IC L: Reset
49	ISCLK2	RMSCNCK	SO		O				O	O	Clock output for scene select DVD control remote control code generation Unused externally
50	P135	PSENB	O	O	O	O			O	O	MATSUSHITA CEC microprocessor reset
51	ISTXD2	RMSCN	SO		O				O	O	Scene select DVD control remote control code output
52	P57	/RES_RX	O		O				O	O	Reset output for HDMI Rx IC L: Reset Pull down at HDMI P.C.B.
53	P56	/RES_TX	O		O				O	O	Reset output for HDMI Rx IC L: Reset Pull down at HDMI P.C.B.
54	P55	/INT_RT	I		I				O	O	HDMI interrupt (Polarity inversion enabled by HDMI Rx,Tx resistor) Connect Rx only Pull up at HDMI P.C.B.
		/EPM	I								47k-ohms pull down for flash write mode
55	P54	/AUPH_A	O	O	O				O	O	ADC output / Rx output for selection of audio path to HDMI L: ADC output, H: Rx output High Fix when VPWR OFF
56	P133	/AUPH	O	O	O				O	O	Video path (Decoder output) to HDMI ON/OFF L: ON, H: HiZ High Fix when VPWR OFF
57	Vss	Vss	MCU		MCU				MCU	MCU	

RX-V863/HTR-6180/DSP-AX863SE/DSP-AX863

Pin No.	Port Name	Function Name (P.C.B.)	I/O							Detail of Function
			Power ON	VPWR OFF	STBY Thrh	STBY CEC	232C ON [232C OFF]	STANDBY [STBY Sleep]	MCU Sleep [Sleep]	
58	P132	/ICS	0	0	0			0	0	Reset output for VIDEO SCALER IC L: Reset Low Fix when VPWR OFF
59	Vcc2	Vcc	MCU		MCU			MCU	MCU	
60	P131	CEC_DPWR	0	0	0			0	0	ON/OFF control of CEC and DSP power supply H: ON, L: OFF DIR, TI DSP, XMIC resetting executed 50ms after DSP power ON
61	P130	/HP	1		0			0	0	Head Phone detect L: Head phone in use
62	P53	VIA	0	0	0			0	0	CVBS/S input select A Low Fix when VPWR OFF
63	P52	VIB	0	0	0			0	0	CVBS/S input select B Low Fix when VPWR OFF
64	P51	VIC	0	0	0			0	0	CVBS/S input select C Low Fix when VPWR OFF
65	P50	BYPASS								BYPASS CVBS/S select Low Fix when VPWR OFF Low Fix when Stby Thrh (10/23 changed) Input port when standby / Sleep / Backup
		/CE	1							
66	P127	SVDET	1	0	0			0	0	S-Video signal detect Low Fix when VPWR OFF
67	P126	/ICV	0		0			0	0	Reset output for VIDEO ENC/DEC IC Low Fix when VPWR OFF
68	P125	/OSDCE	CS	0	0			0	0	Chip enable output for OSD IC Low Fix when VPWR OFF Data is taken in with PSV port set to High 20ms after resetting is cancelled
		MOD2	1							
69	P47	/MTVR1	0	0	0			0	0	VCR1 MUTE Low Fix when VPWR OFF
70	P46	/MTVR2	0	0	0			0	0	VCR2 MUTE Low Fix when VPWR OFF
71	P45	/MTMON	0	0	0			0	0	Monitor MUTE Low Fix when VPWR OFF
72	P44	CPNTD	1	0	0			0	0	Component signal detect Low Fix when VPWR OFF
73	P43	LSEL0	0	0	0			0	0	L1 to 3 select 0 Low Fix when VPWR OFF
74	Vcc2	Vcc	MCU		MCU			MCU	MCU	
75	P42	LSEL1	0	0	0			0	0	L1 to 3 select 1 Low Fix when VPWR OFF
76	Vss	Vss	MCU		MCU			MCU	MCU	
77	P41	CKEV	0		0			0	0	PATAPATA synchronous clock output for electronic volume
78	P40	DTEV	0		0			0	0	PATAPATA synchronous data output for electronic volume
79	P37	/MTHP	0		0			0	0	Mute Head Phone
80	P36	/MTCT	0		0			0	0	Mute Center
81	P35	/MTSW	0		0			0	0	Mute SW
82	P34	/MTSB	0		0			0	0	Mute SBL/SBR
83	P33	/MTFS	0		0			0	0	Mute FL/FR/SL/SR
84	P32	/MTZ2	0		0			0	0	Mute Zone2
85	P31	CKEX	0		0			0	0	BATABATA synchronous clock output for expansion input selector
86	P124	DTEX	0		0			0	0	BATABATA synchronous data output for expansion input selector

Pin No.	Port Name	Function Name (P.C.B.)	I/O							Detail of Function
			Power ON	VPWR OFF	STBY Thrh	STBY CEC	232C ON [232C OFF]	STANDBY [STBY Sleep]	MCU Sleep [Sleep]	
87	P123	CEP	CS		O			O	O	Chip enable output for tuner PLL
		HDRD_N_RST	I		I			I	[I]	Reset output for HD Radio Use prohibited, always set to input (HiZ) Data is taken in with PSV port set to High 20ms after resetting is cancelled (U model)
		MOD1	I							Model detect 1 (net)
88	RXD6	SDRP	SI		I			O	O	Synchronous data input for tuner PLL
		HDRD_MISO	SI		I			O	O	Asynchronous data input for HD Radio (U model)
89	CLK6	SCKP	SO		O			O	O	Synchronous clock output for tuner PLL
90	TXD6	SDTP	SO		O			O	O	Synchronous data output for tuner PLL
		HDRD_MOSI	SO		O			O	O	Asynchronous data output for HD Radio (U model)
91	Vcc2	Vcc	MCU		MCU			MCU	MCU	
92	P30	TMT	O		O			O	O	TUNER Mute output H: Mute Always Mute when tuner is not selected
93	Vss	Vss	MCU		MCU			MCU	MCU	Commonly used with ZONE mute being in use when selecting FM/AM band
94	P27	/TUNED	I		I			O	O	TUNER TUNED input Pull up to +5S
95	P26	/ST	I		I			O	O	TUNER STEREO input Pull up to +5S
96	P25	PSV	O		O			[O]	O	+5S ON/OFF control * +5S is OFF in the sleep mode so as to reduce wasteful power consumption when set to low power consumption (Mute circuit, pull up, etc.) * Shifted to sleep mode about 10 seconds after SYSTEM OFF
97	P24	PRY	O		O			O	O	Power relay control
98	P23	PRI	I		I			O	O	Protection excess current detect
99	P22	Z2RY	O		O			O	O	ZONE2 SP relay control Z2RY and SPB must not be High at the same time
100	P21	SBRY	O		O			O	O	Surround back SP relay control
101	P20	SPC	O		O			O	O	Center & surround SP relay control
102	INT5	PDET	IRQ						O	Interrupt input for power down detect
103	INT4	/PSW	IRQ						O	MAIN power/ZONE2 power /SCENE1-4SW interrupt Pressed SW is judged by ADKEY0 and ADKEY1
104	INT3	REM	IRQ						O	Remote control pulse input
105	P14	SPB	O		O			O	O	Front SP B relay control
106	P13	SPA	O		O			O	O	Front SP A relay control
107	P12	SP_IMP	O		O			O	O	±B voltage control by impedance selection Power consumption is reduced because B voltage becomes Low Low (Relay OFF, B voltage High) when set to 8 ohm, High (Relay ON, B voltage Low) when set to 6 ohms and temperature rises
108	P11	TRIG	O		O			O	O	DC TRIGGER output
109	P10	PDLED	O		O			O	O	Pure direct LED
110	P07	/RSTFD	O		O			O	O	Reset output for FL driver
111	P06	ISA	I		O			O	O	Rotary A for input selector
112	P05	ISB	I		O			O	O	Rotary B for input selector
113	P04	TONEA	I		O			O	O	Rotary A for TONE/PROGRAM
114	P114	TONEB	I		O			O	O	Rotary B for TONE/PROGRAM
115	P113	VRA	I		O			O	O	
116	ISRXD1	RXDSR	SI		O			O	O	Rotary A for volume Asynchronous communication data input for SIRIUS radio Serial communication is 5V TTL/CMOS logic level Pull Down by 100k-ohms
117	P111	VRB	I		O			O	O	Rotary B for volume

RX-V863/HTR-6180/DSP-AX863SE/DSP-AX863

Pin No.	Port Name	Function Name (P.C.B.)	I/O							Detail of Function	
			Power ON	VPWR OFF	STBY Thrh	STBY CEC	232C ON [232C OFF]	STANDBY [STBY Sleep]	MCU Sleep [Sleep]		
118	ISTXD1	TXDSR	SO		O				O	O	Asynchronous communication data output for SIRIUS radio Serial communication is 5V TTL/CMOS logic level (U, C models)
119	P03	SCEN0	O		O				O	O	SCENE button LED control 0
120	P02	SCEN1	O		O				O	O	SCENE button LED control 1
121	P01	SCEN2	O		O				O	O	SCENE button LED control 2
122	P00	/CEFD	CS		O				O	O	Chip enable output for FL driver Data is taken in with PSV port set to High 20 ms after resetting is cancelled
		MOD0	I								Model detect 0 (RX/HTR)
123	P157	DKPWR	O		O				O	O	DOCK power control output / H: ON, L: OFF
124	P156	/MIC	I		O				O	O	MIC detect
125	AN155	PLDET	AD		AD				O	O	SP output level detect for AD power limiter Refer to the limiter setting table
126	AN154	PRD	AD		AD				O	O	AD protection power amplifier DC detect Refer to the protection setting table
127	P153	/SRPWR	O		I				I	I	SIRIUS radio power enable output L: Power ON HiZ: Power OFF Used as input port because SIRIUS power turns ON if set to Low Fix when in the Standby/Sleep mode (U, C models)
128	AN152	DKID	AD		AD				AD	O	AD Dock ID judgment The type of Dock being connected is judged and operation is changed
129	ISCLK0	SCKN	SO		O				O	O	Synchronous clock output for FL DRIVER IC
			SO		O				O	O	Synchronous clock output for OSD IC
130	Vss	Vss	MCU		MCU				MCU	MCU	
131	ISTXD0	SDTN	SO		O				O	O	Synchronous data output for FL DRIVER IC
			SO		O				O	O	Synchronous data output for OSD IC
132	Vcc1	Vcc	MCU		MCU				MCU	MCU	
133	AN7	ADKEY0	AD		AD				[I]	O	AD KEY1 for taking in AD value
134	AN6	ADKEY1	AD		AD				[I]	O	AD KEY0 for taking in AD value
135	AN5	PRV1	AD		AD				O	O	AD protection power voltage detect1
136	AN4	PRV2	AD		AD				O	O	AD protection power voltage detect2
137	P103	VPWR	O		O				O	O	CIDEO power control Low when VIDEO OFF Set according to specifications of pure direct and return to Low Fix when in Standby/Sleep mode
138	AN2	THM	AD		AD				O	O	AD temperature detect Refer to the protection setting table
139	AN1	DEST	AD		AD				O	O	AD destination discrimination Data is taken in when resetting is cancelled
140	AVss	AVss	MCU		MCU				MCU	MCU	
141	P100	iPAP	I		I				I	O	iPod accessory power detect Becomes Low while iPod is booting (for about 2 seconds) Identification executed when booting is judged as completed
142	Vref	VREF	MCU		MCU				MCU	MCU	
143	AVcc	AVcc	MCU		MCU				MCU	MCU	
144	RXD4	RXDi	SI		I				I	O	Asynchronous data input for iPod

Standby --- All Zone power OFF, Master ON
MCUSleep --- Low current consumption state at Master OFF

RX-V863/HTR-6180/DSP-AX863SE/DSP-AX863

Key detection for AD port

Key input (A/D) pull-up resistance 10 k-ohms

RX-V863 (U, C, R, T, K, A, G, E, F, L models), HTR-6180 (U, F models)

Ohm	0	+1.0 k	+1.0 k	+1.5 k	+2.2 k	+3.3 k	+4.7 k	+4.7 k	+6.8 k	+10.0 k	+22.0 k
V	0-0.23	0.24-0.64	0.65-1.06	1.07-1.55	1.56-2.09	2.10-2.62	2.63-3.06	3.07-3.40	3.41-3.73	3.74-4.07	4.08-4.45
ADKEY0 (133 pin)	SYSTEM OFF	SCENE1	SCENE2	-	-	STRAIGHT	ZONE CONTROL	SEARCH MODE/EDIT	-	SPEAKERS	PURE DIRECT
ADKEY1 (134 pin)	Zone2 ON/OFF	SCENE3	SCENE4	ZONE CONTROL	AUDIO SELECT	FM/AM	A/B/C/D/E	PRESET <	PRESET >	MEMORY	INFO

HTR-6180 (C model), DSP-AX8631 (J model)

Ohm	0	+1.0 k	+1.0 k	+1.5 k	+2.2 k	+3.3 k	+4.7 k	+4.7 k	+6.8 k	+10.0 k	+22.0 k
V	0-0.23	0.24-0.64	0.65-1.06	1.07-1.55	1.56-2.09	2.10-2.62	2.63-3.06	3.07-3.40	3.41-3.73	3.74-4.07	4.08-4.45
ADKEY0 (133 pin)	-	SCENE1	SCENE2	-	-	STRAIGHT	ZONE CONTROL	SEARCH MODE/EDIT	-	SPEAKERS	PURE DIRECT
ADKEY1 (134 pin)	MUTE	SCENE3	SCENE4	SLEEP	AUDIO SELECT	FM/AM	A/B/C/D/E	PRESET <	PRESET >	MEMORY	INFO

DSP-AX863SE (B model)

Ohm	0	+1.0 k	+1.0 k	+1.5 k	+2.2 k	+3.3 k	+4.7 k	+4.7 k	+6.8 k	+10.0 k	+22.0 k
V	0-0.23	0.24-0.64	0.65-1.06	1.07-1.55	1.56-2.09	2.10-2.62	2.63-3.06	3.07-3.40	3.41-3.73	3.74-4.07	4.08-4.45
ADKEY0 (133 pin)	-	SCENE1	SCENE2	-	-	STRAIGHT	ZONE CONTROL	-	-	SPEAKERS	PURE DIRECT
ADKEY1 (134 pin)	-	SCENE3	SCENE4	-	AUDIO SELECT	-	-	-	-	-	-

Destination detection for AD port

Pull-up resistance 10 k-ohms

Ohm	0.0 k	1.2 k	2.7 k	4.7 k	6.8 k	10.0 k	15.0 k	27.0 k	47.0 k	100.0 k	-
V	0-0.3	0.4-0.7	0.8-1.3	1.4-1.8	1.9-2.2	2.3-2.7	2.8-3.2	3.3-3.8	3.9-4.3	4.4-4.7	4.8-5.0
A/D (5 V=255)	0-13	14-40	41-68	69-92	93-115	116-140	141-170	171-198	199-221	222-243	245-255
DEST, 139pin	J	U, C	-	R	T	K	A	B	G, E, F	L	-

Model detection

1: Pull-up / 0: Pull-down

Model	RX-V863/DSP-AX863SE/DSP-AX863	HTR-6180
/CEFD/MOD0 (122 pin)	0	1

PIN CONNECTION DIAGRAMS

ICs

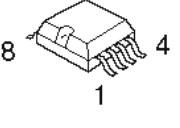
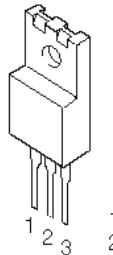
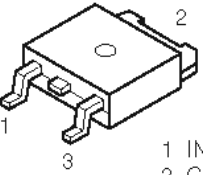
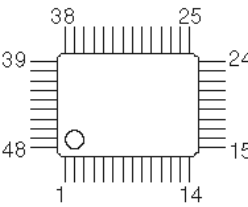
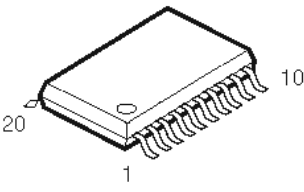
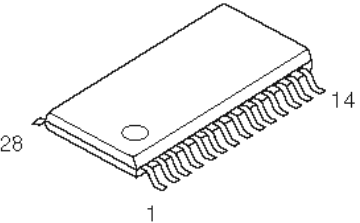
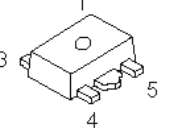
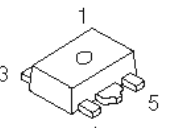
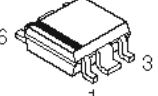
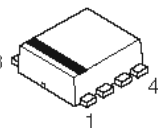
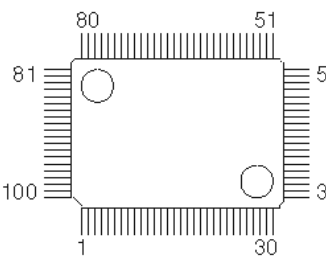
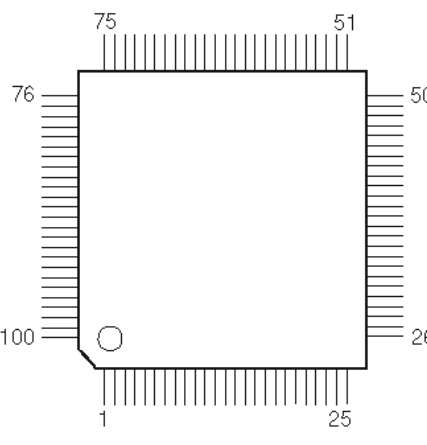
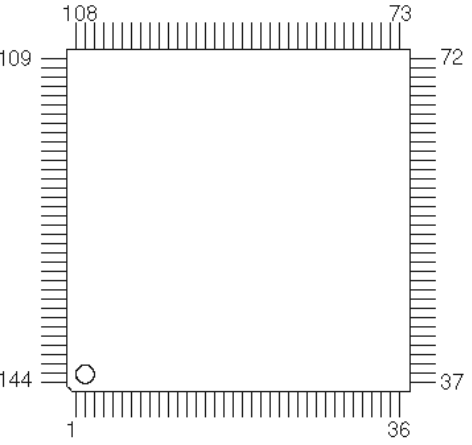
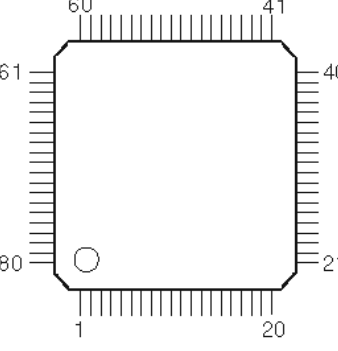
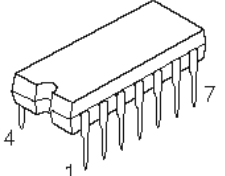
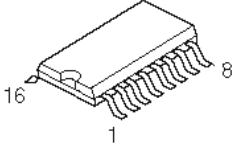
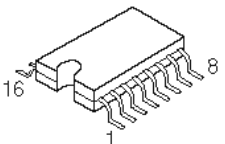
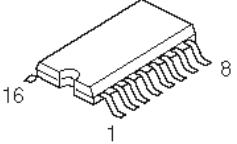
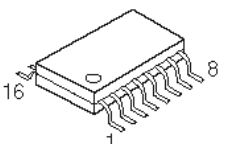
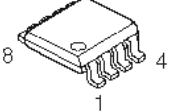

<p>ABT1010PQ100A</p>	<p>ADV7172KST</p>	<p>ADV7800BSTZ-80</p>	<p>BA15218F</p>		
<p>BD3841FS</p>	<p>D70YE101BRFP266 M30878FJBG</p>	<p>EN29LV160AB-70TCP</p>	<p>F2621E-01-TR</p>		
<p>KIA7912PI</p>	<p>LA73050-TLM-E</p>	<p>LC72725KM-UY-TLM-E PCM1780DBQR PCM1781DBQR</p>	<p>LC74782JM-8A16-TLMC</p>		
<p>LC89057W-VF4AD-E</p>	<p>LM61CIZ</p>	<p>M12L64164A-5TG</p>	<p>M66003-0131FP-R</p>	<p>MN103SFD7G</p>	
<p>NJM2068MD-TE2</p>	<p>NJM2388F05</p> <p>1 VIN 2 VOUT 3 GND 4 ON/OFF CONTROL</p>	<p>NJM2388F09 NJM2396F33</p> <p>1 VIN 2 VOUT 3 GND 4 ON/OFF CONTROL</p>	<p>NJM2581M TC74VHC08FT TC74VHC04FT</p>	<p>NJM2867F3-05 TC7SET32FU TC7SH04FU</p>	<p>NJM4565M</p>

<p>NE5532DR</p> 	<p>NJM7805FA NJM7812FA</p>  <p>1 INPUT 2 GND 3 OUTPUT</p>	<p>NJM78M05DL1A</p>  <p>1 IN 2 GND 3 OUT</p>	<p>NJW1321FP1</p> 	<p>PCM1803DBR SN74LVC245APWR SN74LVTH245APW TC74VHC541FT TC74VHCT541AFT</p> 		
<p>PCM1680DBQR</p> 		<p>R1154H058B-T1-F</p> 	<p>R1172H181B-T1-F R1172H331D-T1-F</p>  <p>1 CE 2 GND 3 NC 4 VDD 5 VOUT</p>	<p>R1172S121D-E2-F R1172S331B-E2-F</p> 	<p>R1232D181A-TR-F</p> 	
<p>R2A15218FP</p> 		<p>Sil9134CTU</p> 		<p>Sil9135CTU</p> 		<p>Sil9185ACTU</p> 
<p>TC4013BP</p> 	<p>TC4051BF</p> 	<p>TC74HC4051AFEL TC74HC4052AF</p> 	<p>TC74HC4053AF</p> 	<p>TC74VHC153FT TC74VHC157FT</p> 	<p>TC7WZ32FK</p> 	

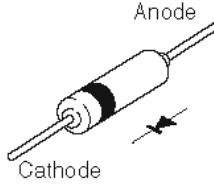
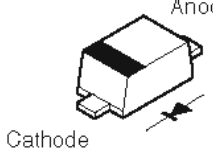
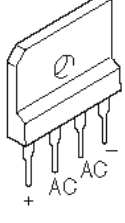
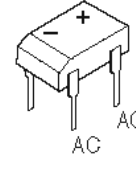
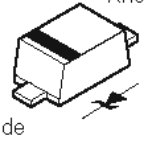
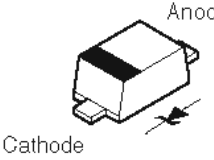
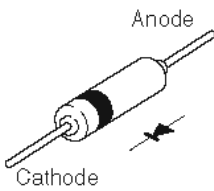
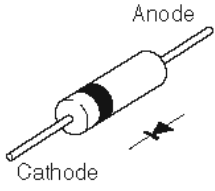
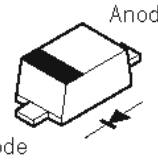
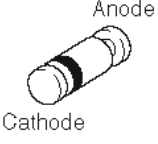
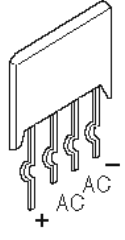
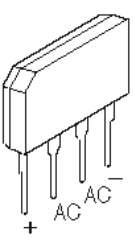
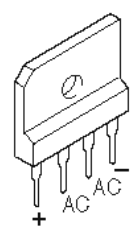
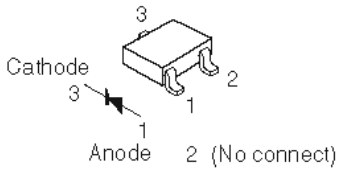
Diodes

<p>1N4002S 1SS133 1SS176 1SS270A</p> 	<p>1SS355 1SS380</p> 	<p>D6SBN20</p> 	<p>DB105</p> 	<p>MA8024-(TX) 2.4V</p> 
<p>MA8030-L 2.9V MA8036 3.6V MA8051-M 5.1V MA8056-M 5.6V MA8068-M 6.8V MA8075-H 7.7V MA8091-L 8.8V</p>	<p>MA8091-M 9.1V MA8100-H 10.3V MA8100-M 10.0V</p> 	<p>MTZJ2.4B MTZJ5.1C MTZJ6.2B MTZJ13B MTZJ15B MTZJ30A</p> 	<p>RB441Q-40</p> 	<p>RB500V-40 RB501V-40</p> 
<p>RLZ7.5B 7.5V</p> 	<p>RS103-B-D-V50</p> 	<p>RS203M-B-C-J80</p> 	<p>RS403M</p> 	<p>SB01-05Q</p> 

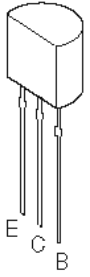
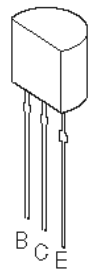
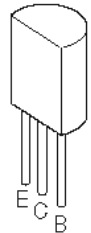
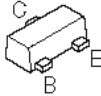
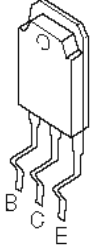
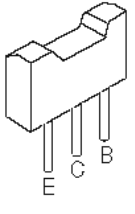
Transistors

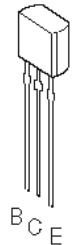
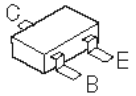
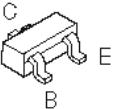
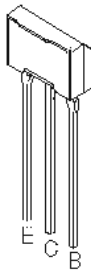
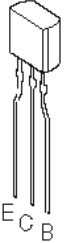
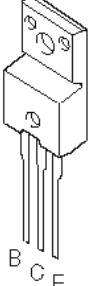
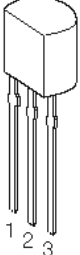
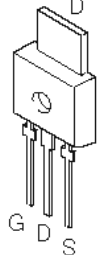
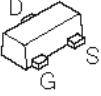
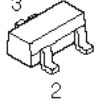
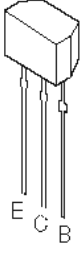
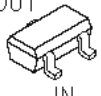
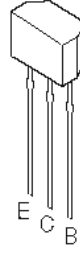
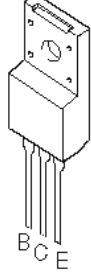
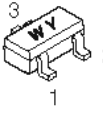
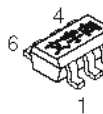
<p>2N5401C-AT/P 2SA1015-Y 2SC2240</p> 	<p>2N5551C-AT</p> 	<p>2SA949 2SC1815 Y 2SC2229</p> 	<p>2SA1576A</p> 	<p>2SA1695 O,P,Y 2SC4468 O,P,Y</p> 	<p>2SA1708</p> 	
<p>2SA1770S/T-AN</p> 	<p>2SC1740S</p> 	<p>2SC2412K</p> 	<p>2SC3326-A (TE85R, F) 2SC3326-B (TE85R, F) 2SC4081 T106 2SD1938F KTA1504S KTC3875S</p> 	<p>2SC4614S/T-AN</p> 	<p>2SD1915F</p> 	<p>2SD2014</p> 
<p>2SK246-Y (TPE2, F)</p>  <p>1 Source 2 Gate 3 Drain</p>	<p>2SK3850</p> 	<p>3LN01C-TB-E</p> 	<p>DTA143EKA DTA144EKA DTC114EKA DTC144EKA</p>  <p>1 GND 2 IN 3 OUT</p>	<p>KRA102M-AT/P</p> 	<p>KRA102S-RTK/P KRC102S-RTK KRC104S-RTK</p> 	
<p>KRC102M-AT</p> 	<p>KTA1046-Y-U/P</p> 	<p>RSR025P03TL</p>  <p>1 GATE 2 SOURCE 3 DRAIN</p>	<p>μPA672T-T1-A</p>  <p>1 Source 1 (S1) 2 Gate 1 (G1) 3 Drain 2 (D2) 4 Source 2 (S2) 5 Gate 2 (G2) 6 Drain 1 (D1)</p>			

1 BLOCK DIAGRAMS
AUDIO (DIGITAL) SECTION BLOCK DIAGRAM

DIGITAL • See page 107-111 →
 SCHEMATIC DIAGRAM

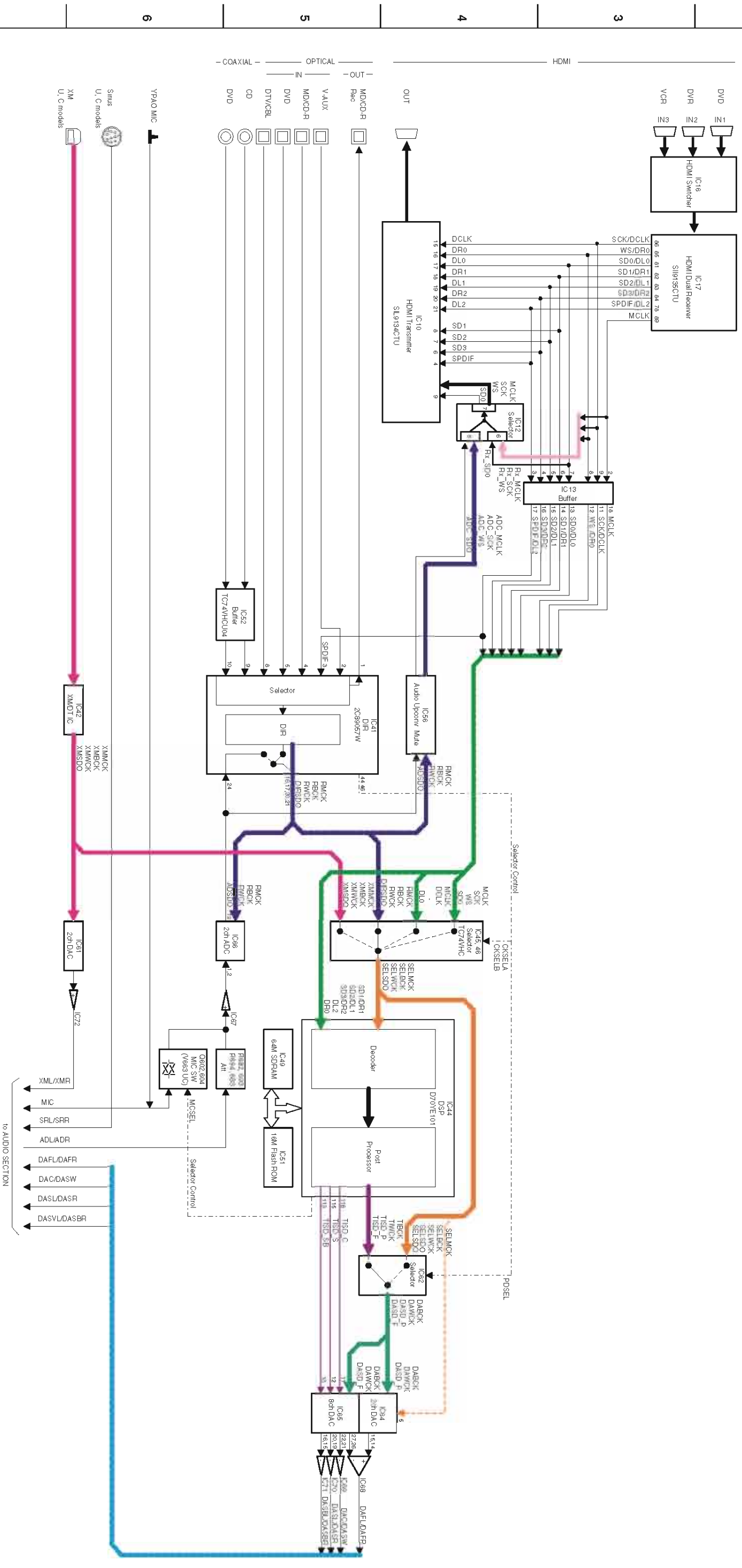

AUDIO (ANALOG) SECTION BLOCK DIAGRAM

FUNCTION • See page 112-113 →
SCHEMATIC DIAGRAM

To AUDIO (DIGITAL) SECTION

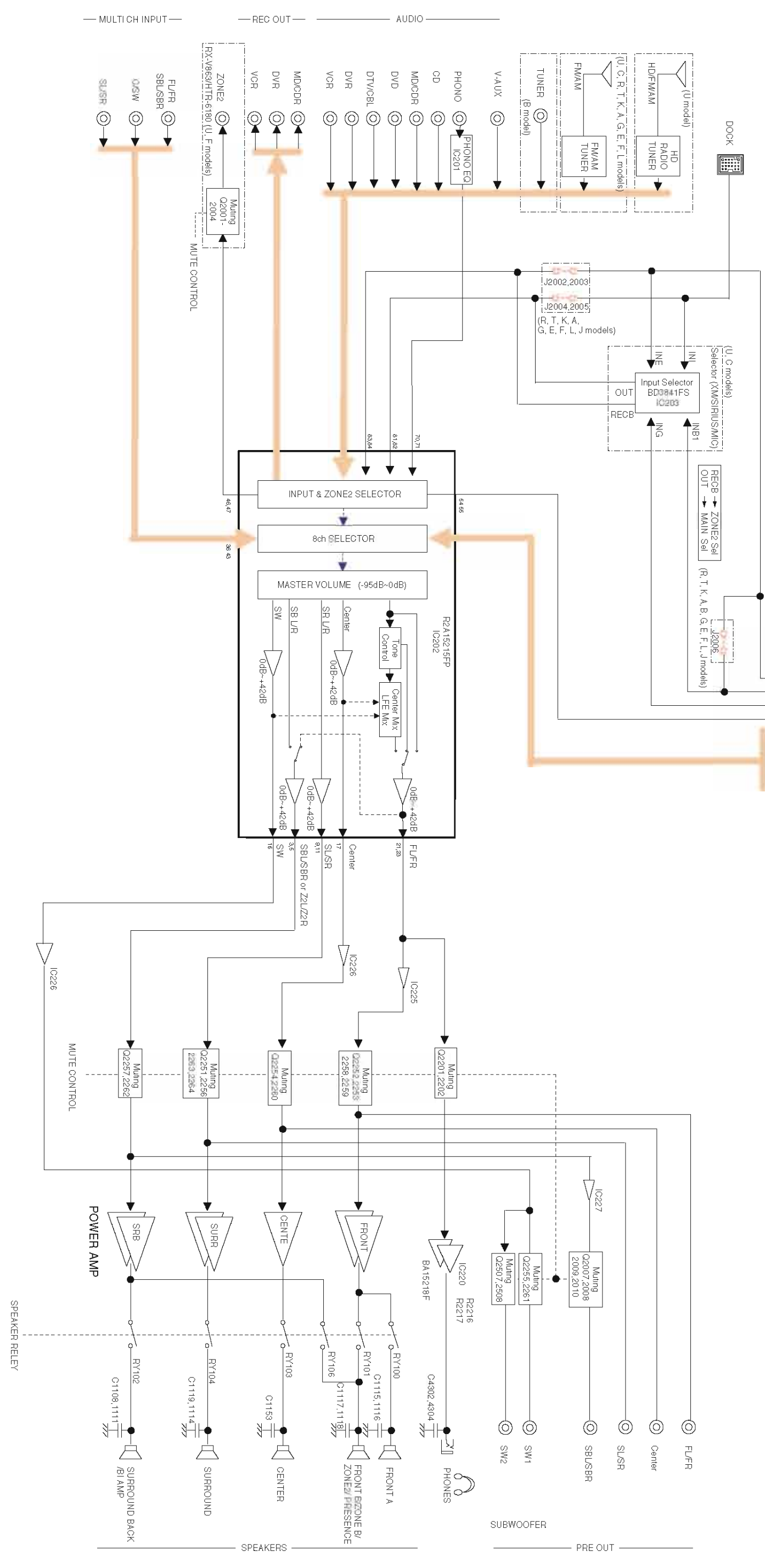

VIDEO SECTION BLOCK DIAGRAM

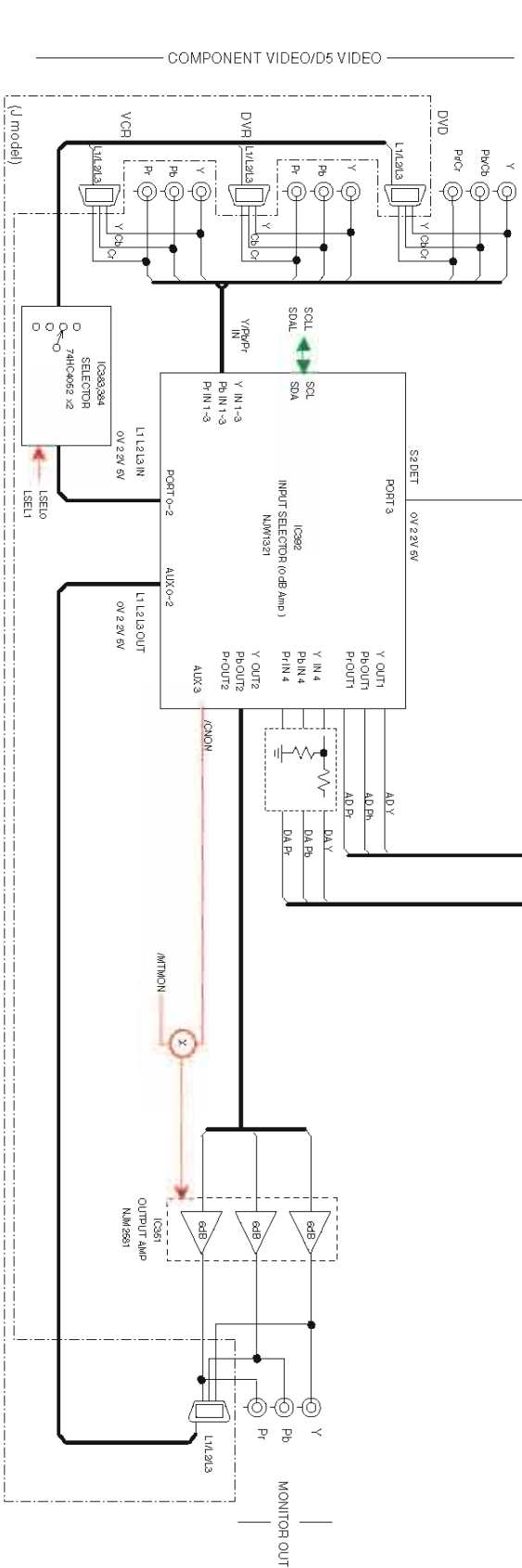
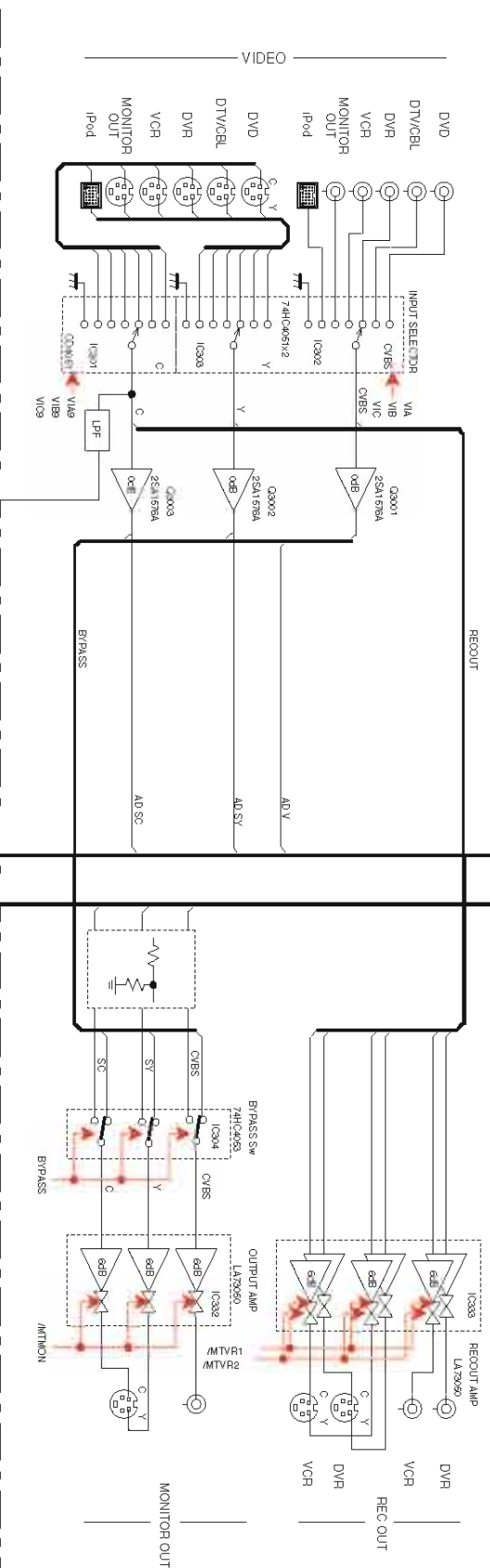
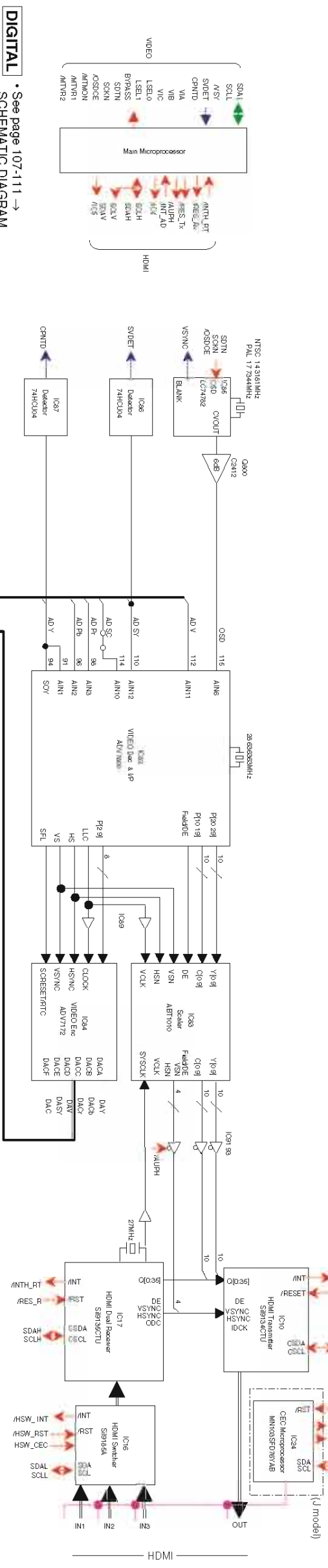

1
2
3
4
5
6
7

A B C D E F G H I J

CONTROL SECTION BLOCK DIAGRAM

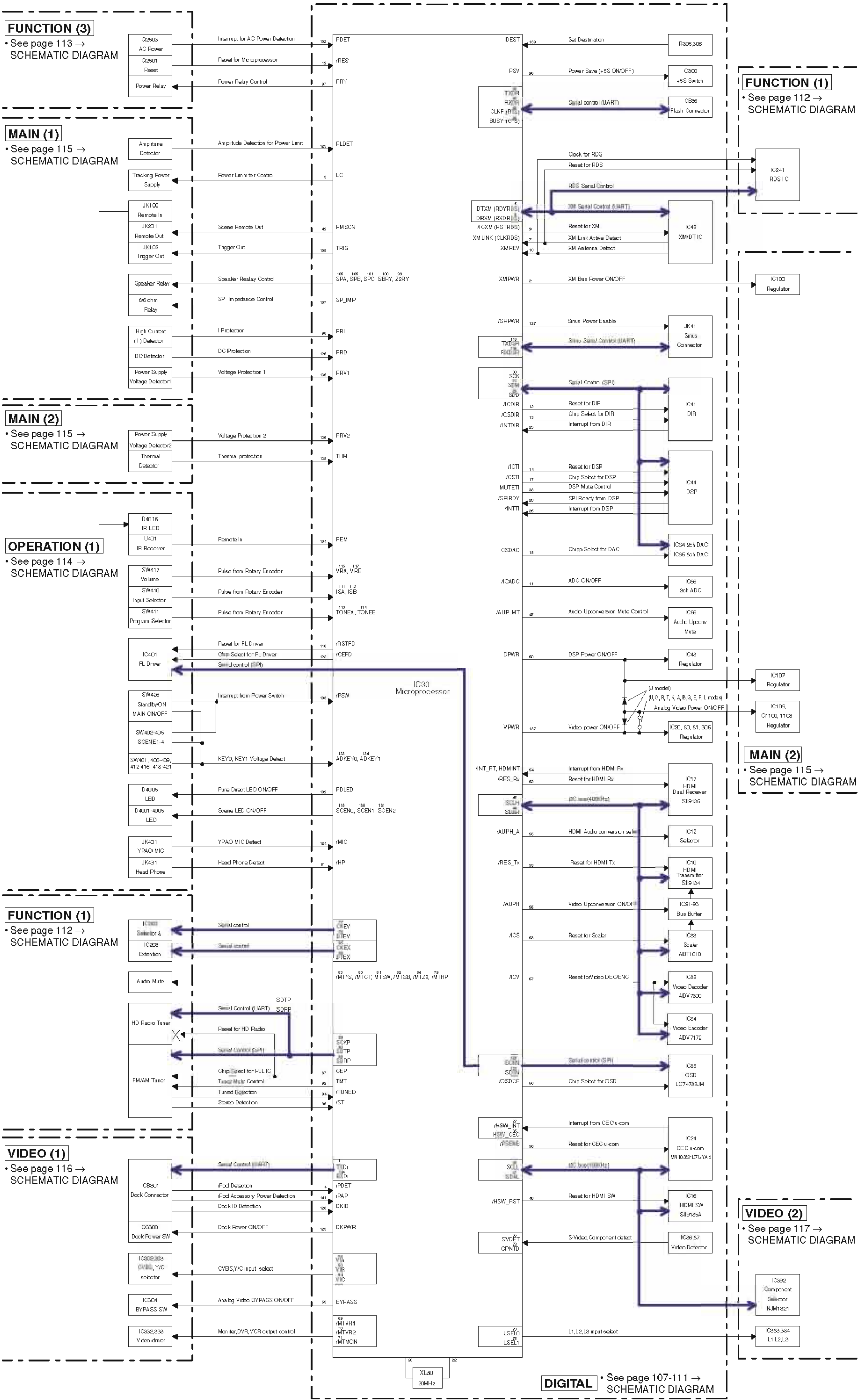

PRINTED CIRCUIT BOARDS

DIGITAL P.C.B. (Side A)

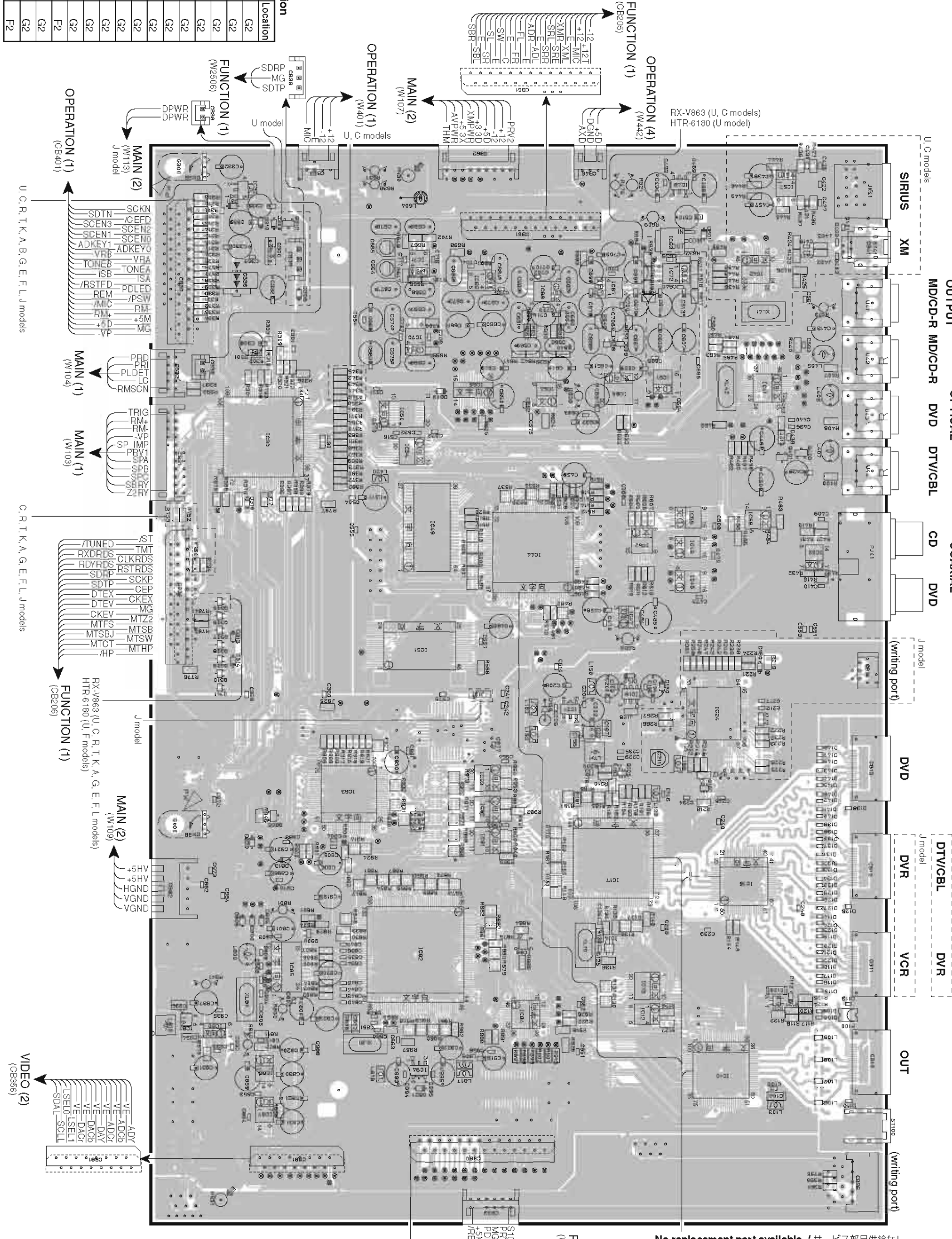

Ref no.	Location	Ref no.	Location
D142	F2	D800	G6
D143	F2	D805	G6
D144	F2	D806	G6
D145	F2	D813	G5
D146	F2	D820	G6
D147	F2	D821	H5
D148	F2	D810	H3
D149	F2	IC11	H2
D150	F3	IC12	H3
D152	F3	IC13	H3
D159	F4	IC14	G3
D160	F3	IC16	G3
D301	D6	IC17	G3
D308	C5	IC19	F3
D309	C6	IC20	F4
D310	C6	IC21	F4
D311	C6	IC24	F3
D313	E6	IC32	D6
D314	F6	IC32	C6
D316	E6	IC41	D3
D401	C2	IC42	C3
D402	C2	IC44	E4
D403	C2	IC45	E3
D601	C3	IC46	E3
D603	D5	IC47	E3
D608	D3	IC48	C3
D609	D3	IC49	E5

No replacement part available. / サービス部品供給なし

Ref no.	Location	Ref no.	Location
IC50	D5	IC85	G5
IC51	D5	IC86	H6
IC52	E2	IC87	H6
IC54	D5	IC89	G4
IC55	E3	IC91	G4
IC56	E3	IC92	F4
IC57	C2	IC93	F4
IC61	D3	IC94	H5
IC62	E3	Q105	F3
IC63	C3	Q107	F3
IC64	D4	Q300	C6
IC65	D4	Q305	E6
IC66	D3	Q306	E6
IC67	C3	Q307	E6
IC68	C4	Q308	E6
IC69	C4	Q309	F6
IC70	D5	Q310	F6
IC71	C5	Q311	F6
IC72	C5	Q312	C5
IC80	H6	Q401	D2
IC81	H6	Q402	D2
IC82	G5	Q800	G5
IC83	F5	Q806	G6
IC84	H4		

Semiconductor Location

Ref no.	Location	Ref no.	Location
D108	H2	D126	G2
D109	H2	D127	G2
D110	H2	D128	G2
D112	H2	D129	G2
D113	H2	D130	G2
D114	G2	D131	G2
D115	H2	D132	G2
D116	H2	D133	G2
D118	H2	D134	G2
D119	G2	D135	G2
D119	G2	D136	G2
D120	G2	D137	G2
D121	G2	D138	F2
D122	G2	D139	G2
D123	G2	D140	G2
D124	G2	D141	F2

Ref no.	Location	Ref no.	Location
IC50	D5	IC85	G5
IC51	D5	IC86	H6
IC52	E2	IC87	H6
IC54	D5	IC89	G4
IC55	E3	IC91	G4
IC56	E3	IC92	F4
IC57	C2	IC93	F4
IC61	D3	IC94	H5
IC62	E3	Q105	F3
IC63	C3	Q107	F3
IC64	D4	Q300	C6
IC65	D4	Q305	E6
IC66	D3	Q306	E6
IC67	C3	Q307	E6
IC68	C4	Q308	E6
IC69	C4	Q309	F6
IC70	D5	Q310	F6
IC71	C5	Q311	F6
IC72	C5	Q312	C5
IC80	H6	Q401	D2
IC81	H6	Q402	D2
IC82	G5	Q800	G5
IC83	F5	Q806	G6
IC84	H4		

DIGITAL P.C.B. (Side B)

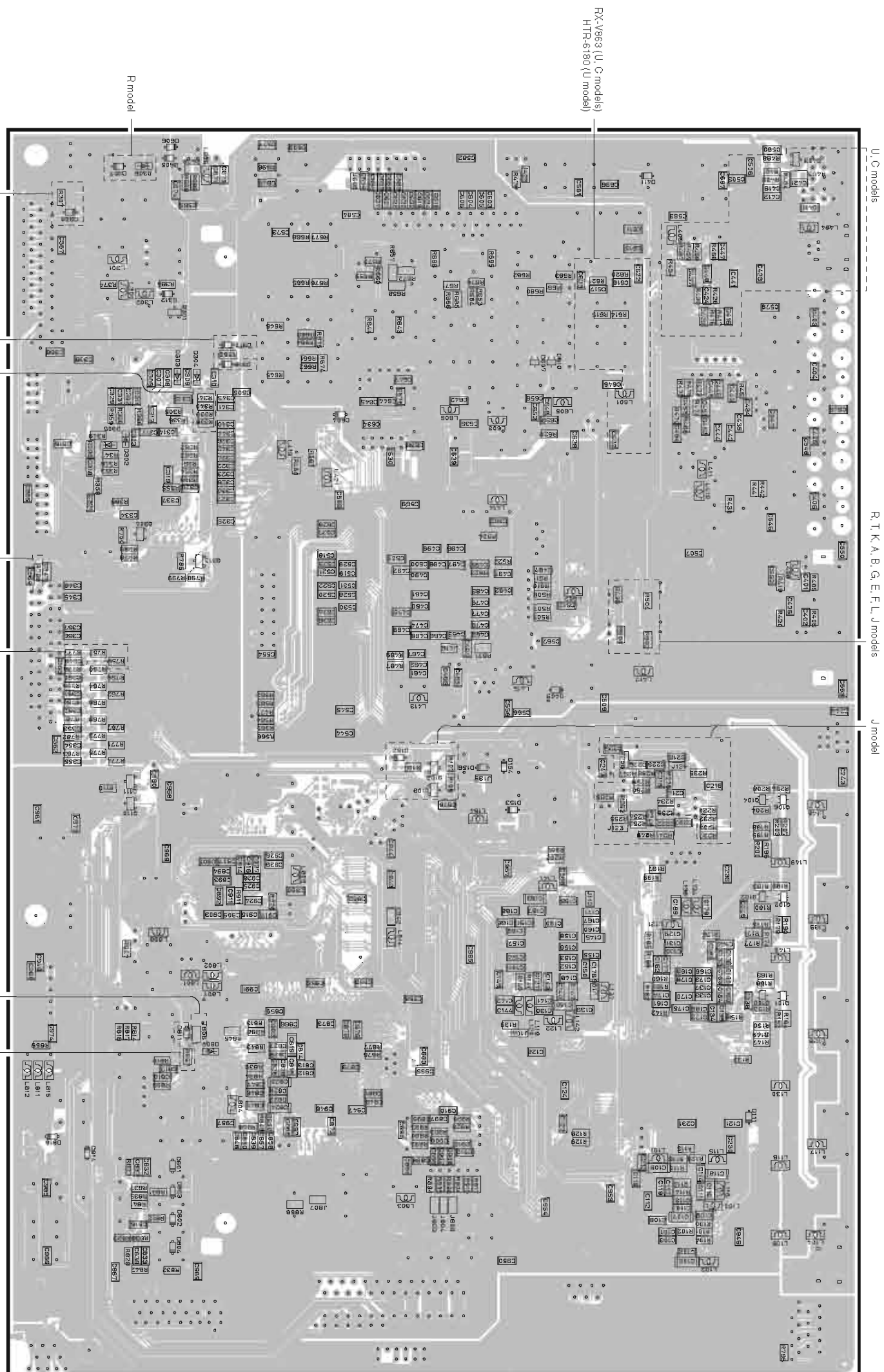

Semiconductor Location

Ref no.	Location	Ref no.	Location
D111	H2	D801	H5
D153	F4	D802	H5
D154	F4	D803	H5
D156	F4	D804	H5
D182	F4	D807	G5
D300	C6	D811	G5
D302	D6	D814	H6
D303	D5	D816	H6
D304	D5	Q100	G2
D305	D6	Q101	G2
D306	C6	Q102	F2
D307	C6	Q103	F2
D312	C5	Q104	F2
D317	D5	Q106	F2
D318	D5	Q108	F4
D409	E3	Q109	F4
D411	C3	Q110	F6
D604	D5	Q111	F6
D605	C5	Q301	C5
D606	C5	Q304	E6
D607	D4	Q313	E5
D610	D3	Q403	C2

FUNCTION (1) P.C.B. (Side B)

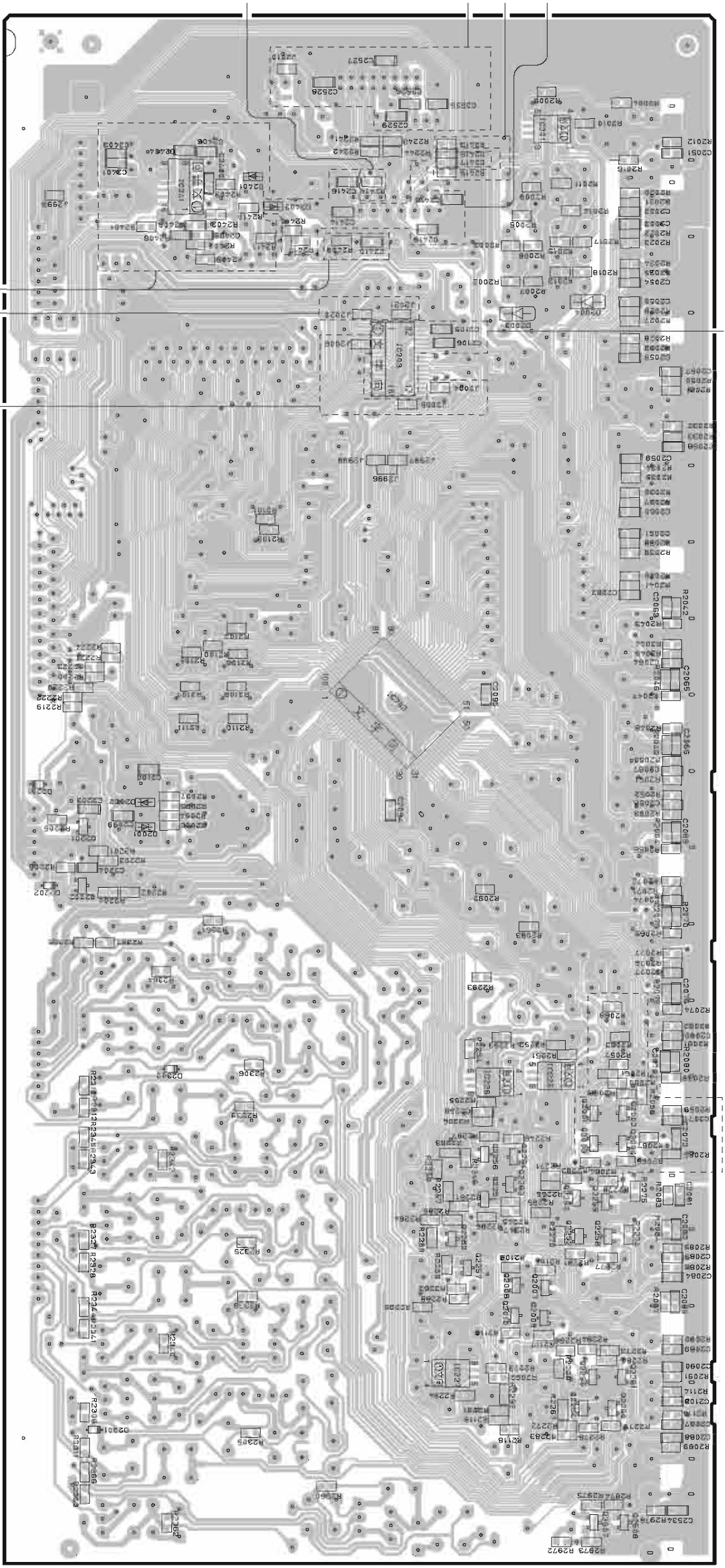

• **Semiconductor Location**

Ref no.	Location	Ref no.	Location	Ref no.	Location	Ref no.	Location	Ref no.	Location	Ref no.	Location	Ref no.	Location
D2001	F5	D2302	G5	IC225	G3	Q2004	H3	Q2251	H3	Q2258	H3	Q2507	I3
D2002	F5	D2401	G5	IC226	G3	Q2007	H3	Q2252	H3	Q2259	H3	Q2508	I3
D2003	C3	D2402	C4	IC227	I4	Q2008	H3	Q2253	H3	Q2260	I3		
D2004	C3	IC201	B3	IC241	C5	Q2009	H3	Q2254	I3	Q2261	I3		
D2201	F6	IC202	E4	Q2001	G3	Q2010	H3	Q2255	I3	Q2262	H4		
D2202	F6	IC203	D4	Q2002	G3	Q2201	F5	Q2256	H3	Q2263	H3		
D2301	I5	IC220	H6	Q2003	H3	Q2202	F5	Q2257	H4	Q2264	H3		

FUNCTION (3) P.C.B. (Side A)

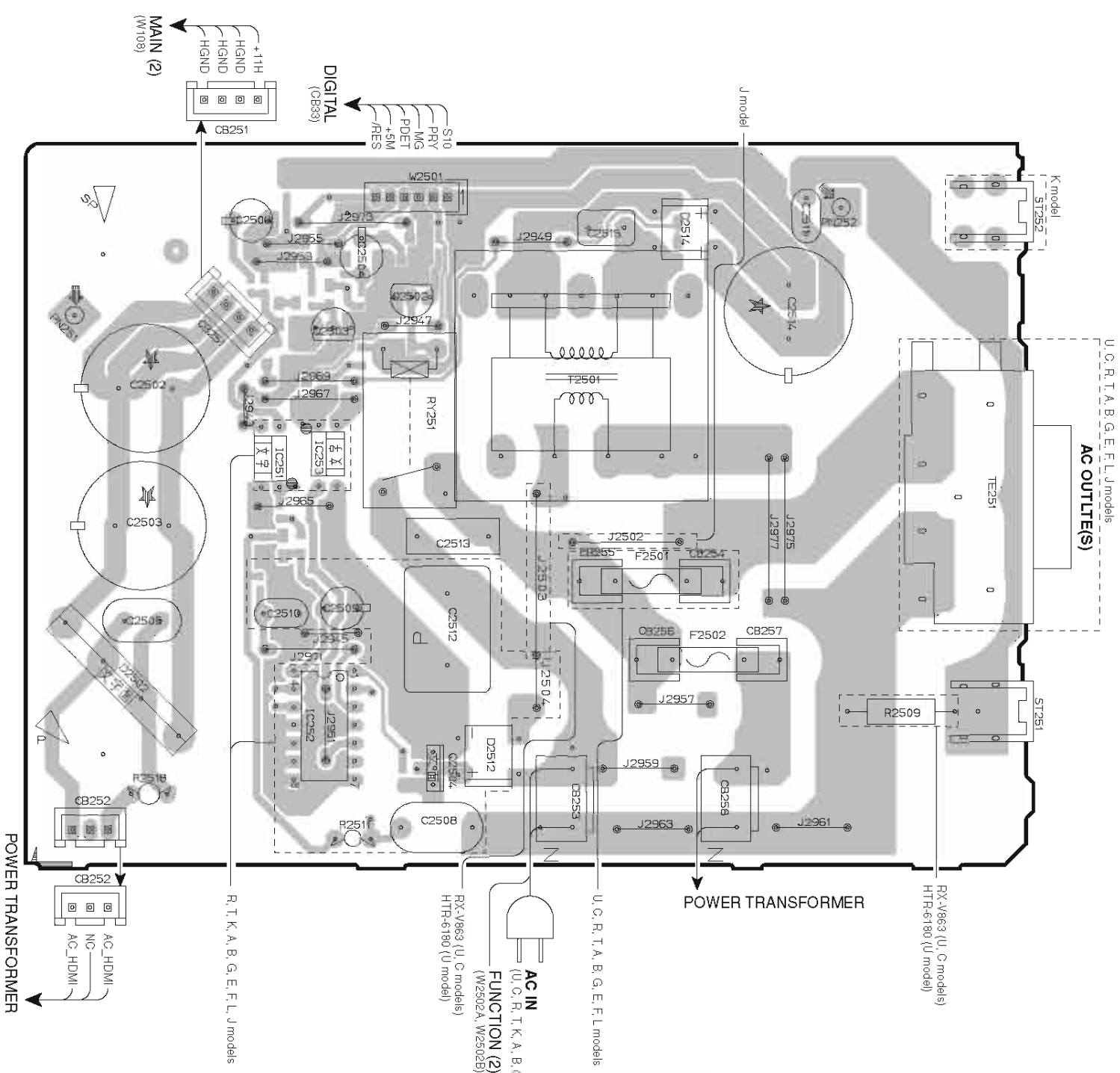

FUNCTION (3) P.C.B. (Side B)

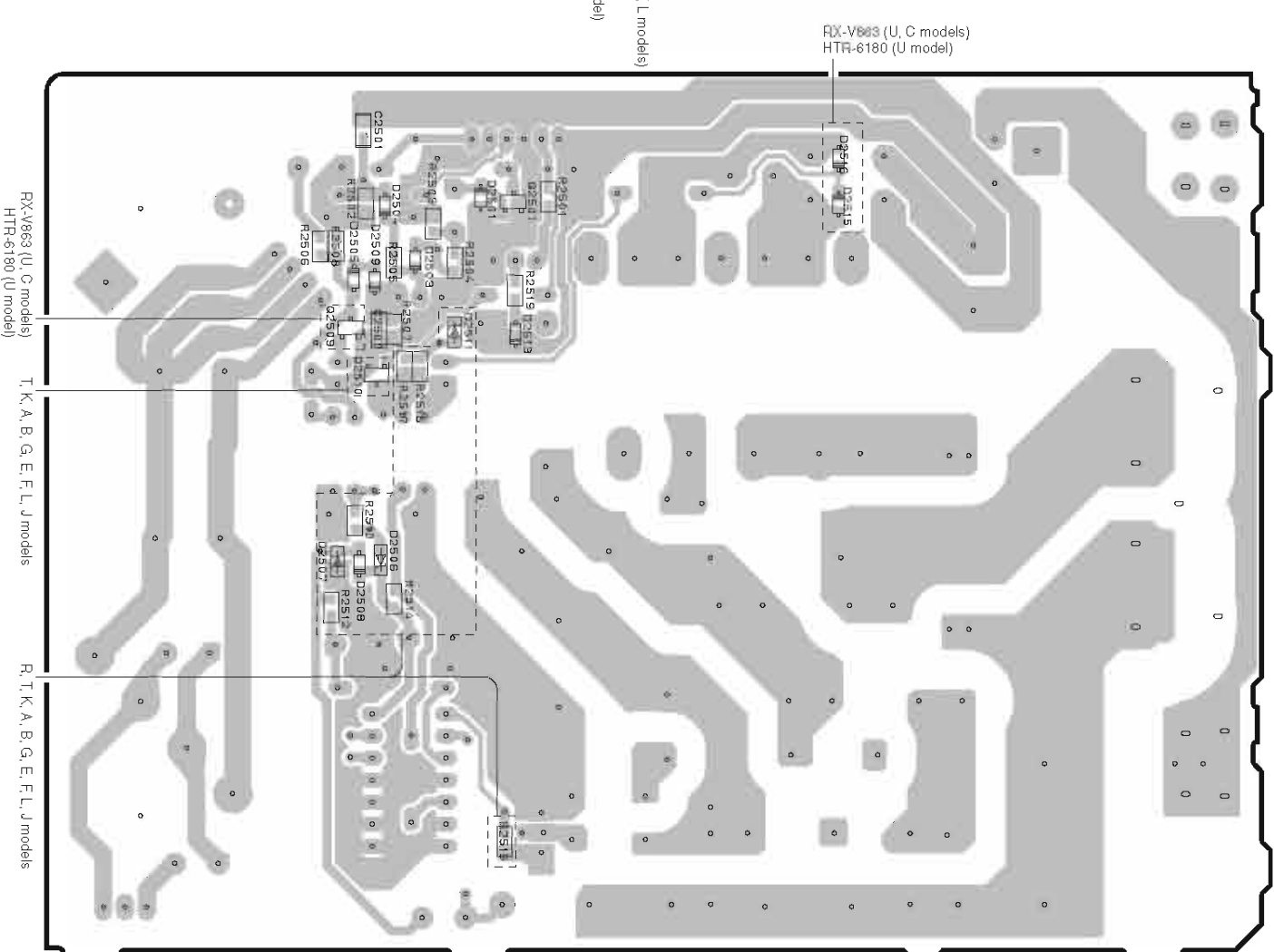

Semiconductor Location

Ref no.	Location	Ref no.	Location	Ref no.	Location	Ref no.	Location	Ref no.	Location
D2501	G5	D2505	G5	D2509	G5	D2514	B3	IC252	D5
D2502	D6	D2506	H5	D2511	G5	D2515	G3	IC253	C5
D2503	G5	D2507	H5	D2512	D4	D2516	G3	Q2501	G5
D2504	G5	D2508	H5	D2513	G5	IC251	C5	Q2502	B5
								Q2509	G5
								Q2510	G5

Circuit No.	RX-V863		RX-V863/HTR-6180/DSP-AX863SE/D5A-AX863	
	C	O	U, C, R, T, K, A, B, G, E, F, L, J	X
J2945, 2951				

FUNCTION (2) P.C.B. (Side A)

J model

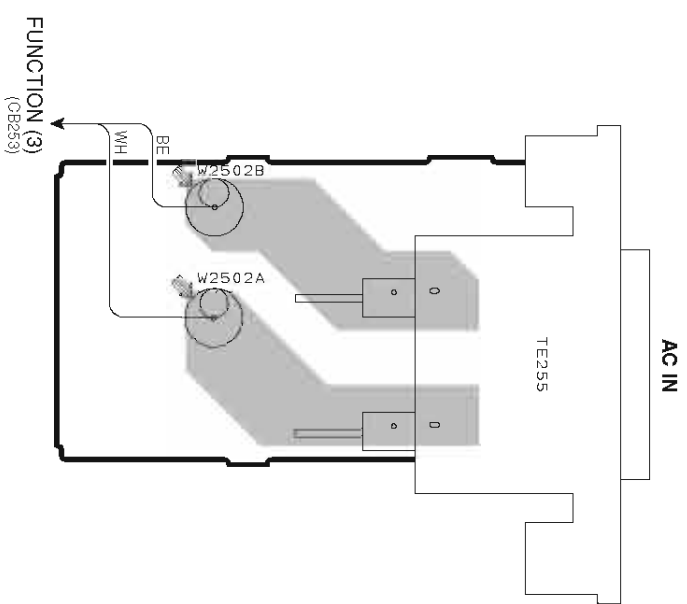

FUNCTION (4) P.C.B. (Side A)

R, L models

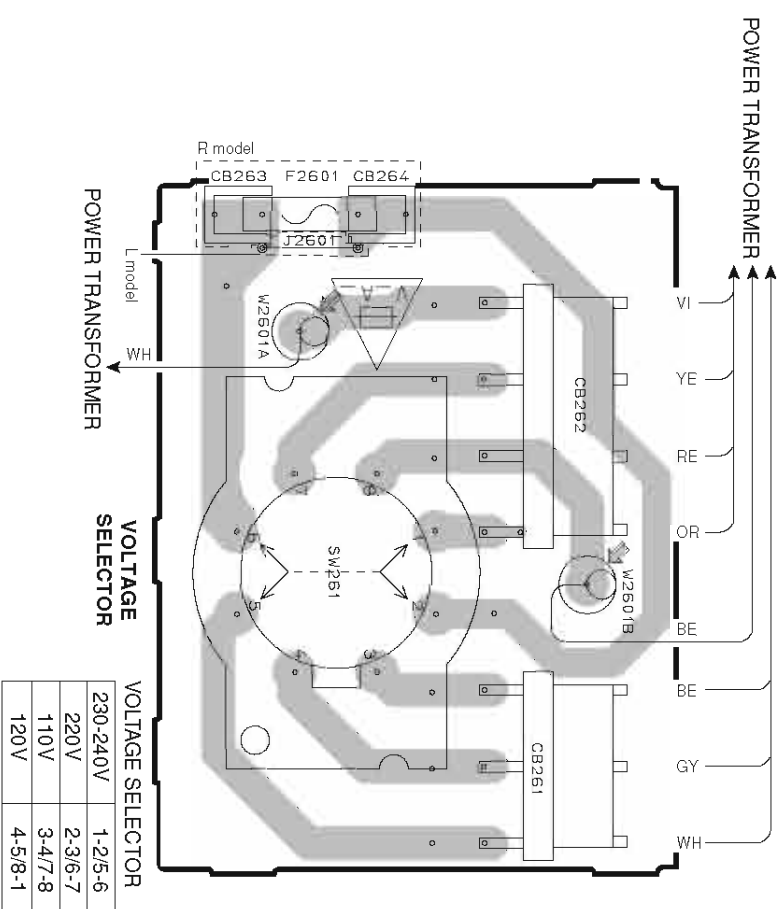

FUNCTION (5) P.C.B. (Side A)

B model

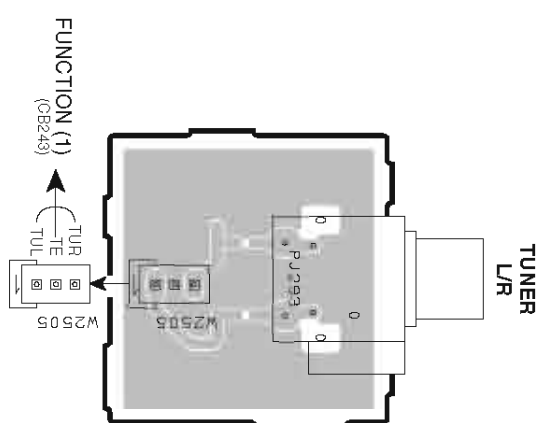

FUNCTION (5) P.C.B. (Side B)

B model

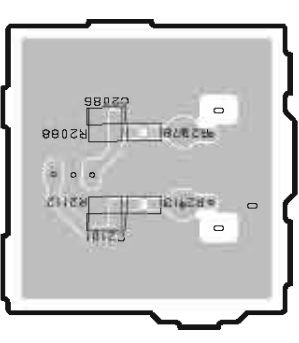

FUNCTION (6) P.C.B. (Side A)

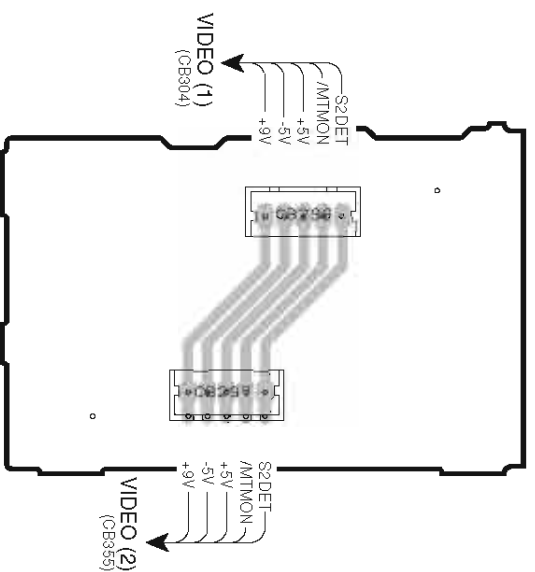

FUNCTION (6) P.C.B. (Side B)

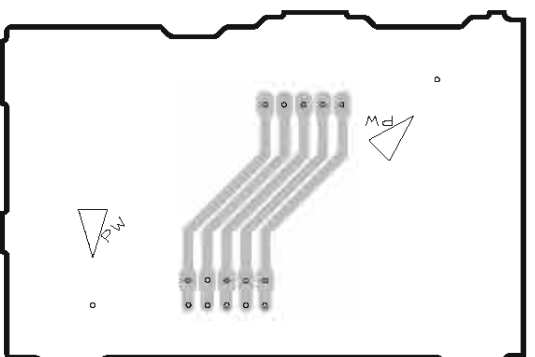

FUNCTION (9) P.C.B. (Side A)

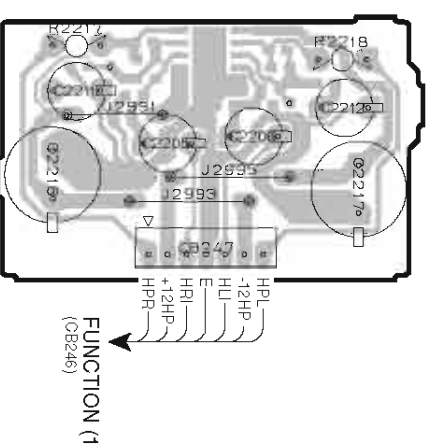

FUNCTION (9) P.C.B. (Side B)

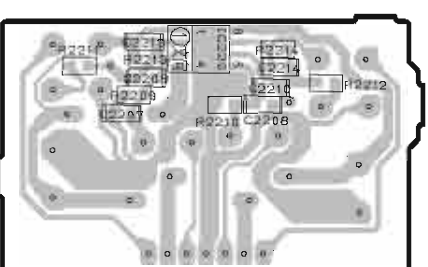

• Semiconductor Location
 Ref no. Location
 IC220 H6

OPERATION (1) P.C.B. (Side A)

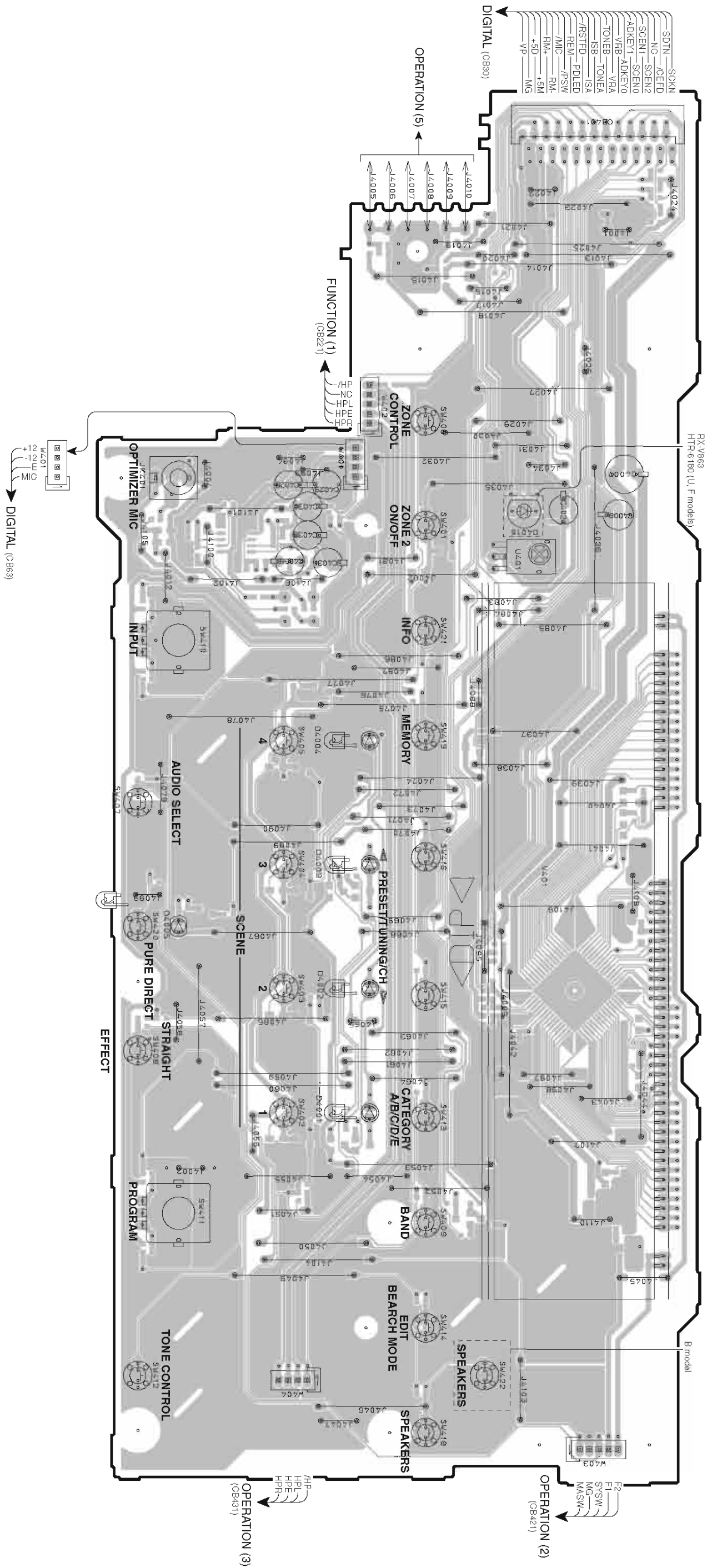

Semiconductor Location

Ref no.	Location	Ref no.	Location	Ref no.	Location
D4001	H4	D4003	F4	D4005	F5
D4002	G4	D4004	E4	D4015	D3

Circuit No.	U, C, R, T, K, A, G, E, L, J	B
SW401, 406, 409, 413-416, 418, 419, 421	O	X

OPERATION (1) P.C.B. (Side B)

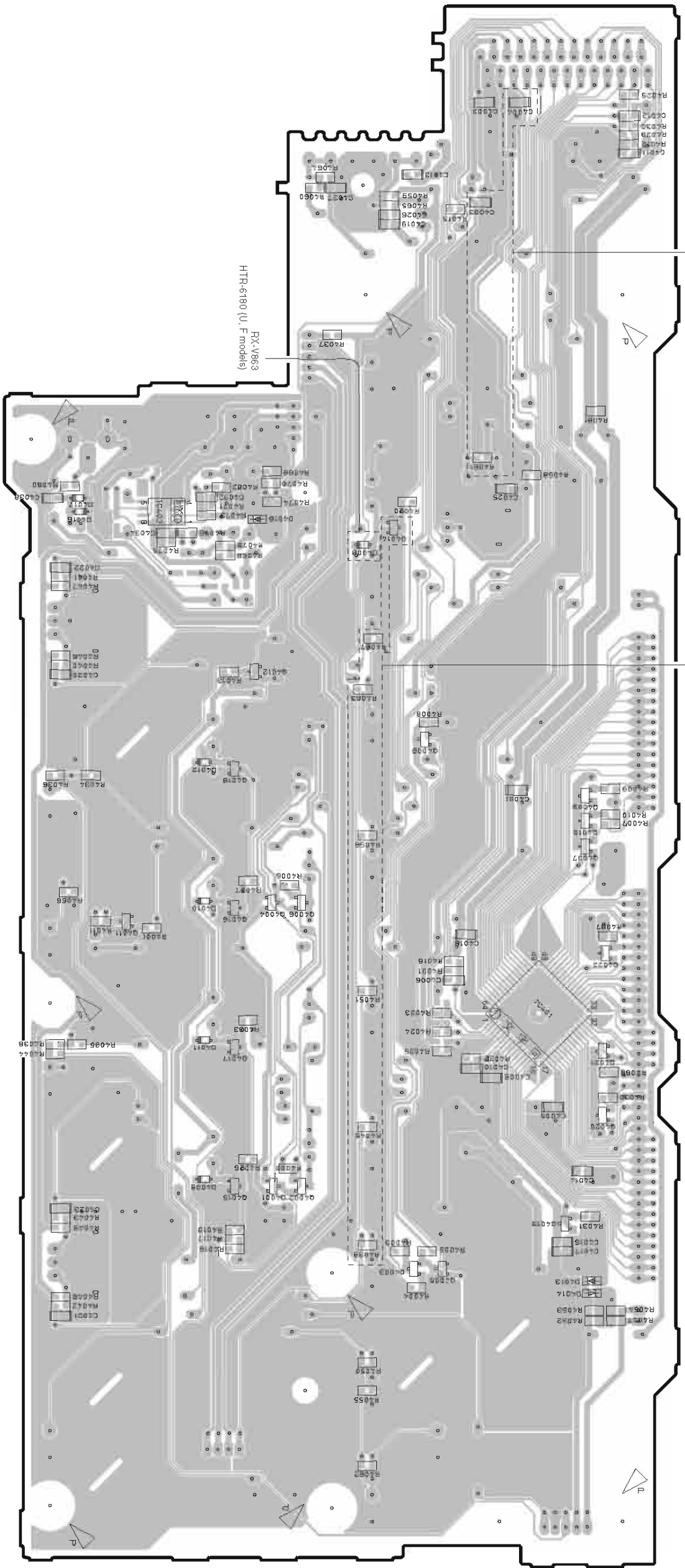

• **Semiconductor Location**

Ref no.	Location	Ref no.	Location	Ref no.	Location	Ref no.	Location
D4008	D4	D4018	D5	Q4007	F3	Q4017	G5
D4009	H5	IC401	G3	Q4008	F4	Q4018	F5
D4010	F5	IC402	D5	Q4009	F3	Q4019	H3
D4011	G5	Q4001	H4	Q4010	F3	Q4020	G3
D4012	E5	Q4002	H4	Q4011	F5	Q4021	G3
D4013	H3	Q4003	H4	Q4012	E5	Q4022	G3
D4014	H3	Q4004	F4	Q4014	D4		
D4016	D6	Q4005	H4	Q4015	H5		
D4017	D6	Q4006	F4	Q4016	F5		

OPERATION (2) P.C.B. (Side A)

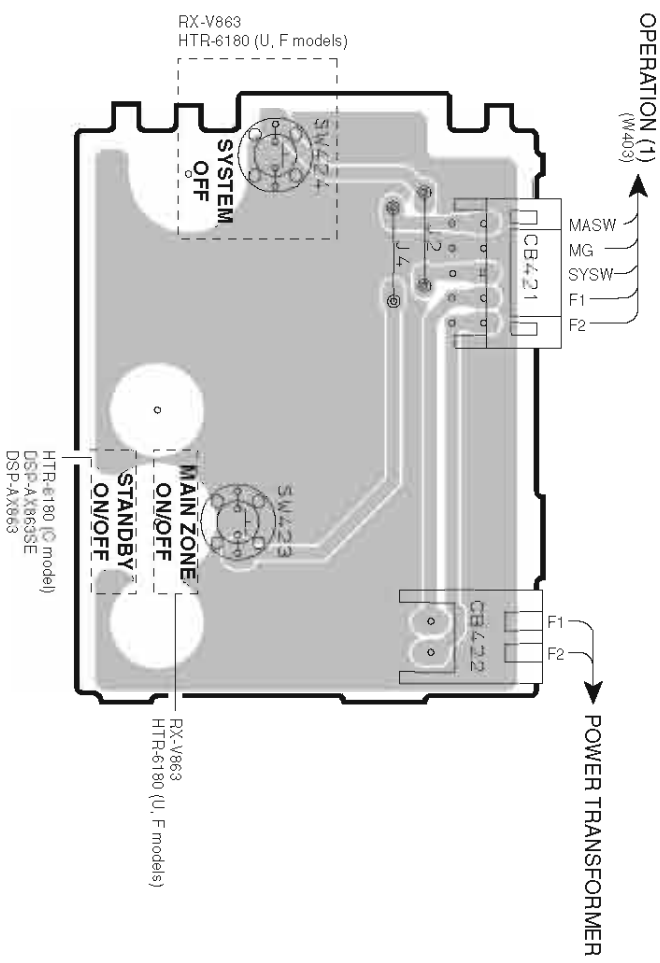

OPERATION (2) P.C.B. (Side B)

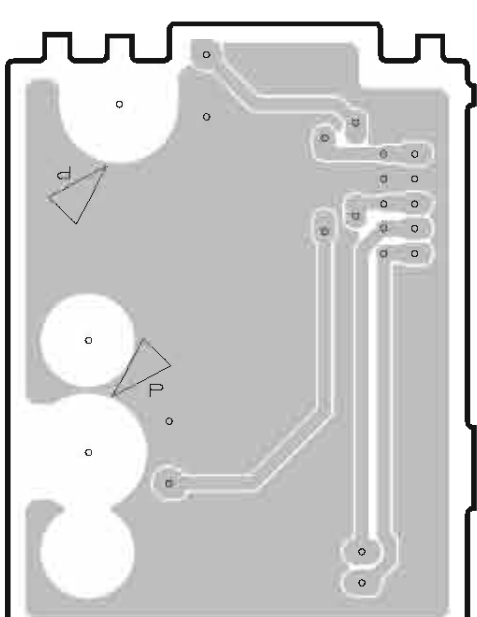

OPERATION (3) P.C.B. (Side A)

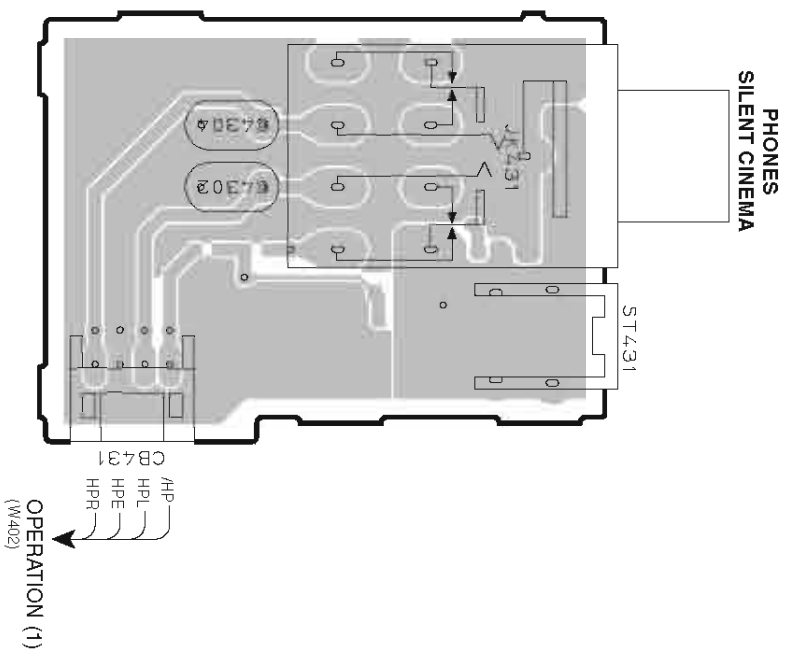

OPERATION (3) P.C.B. (Side B)

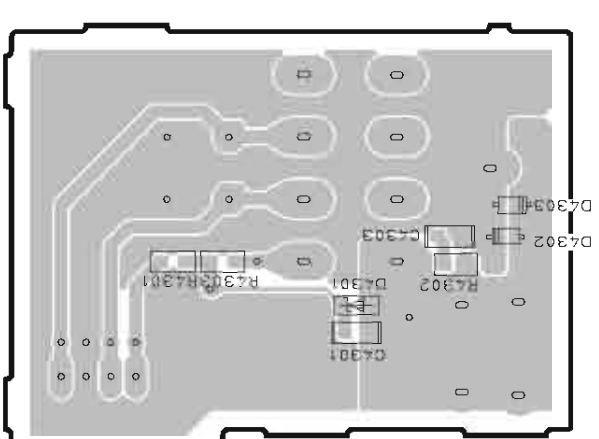

• Semiconductor Location

Ref no.	Location
D4301	H6
D4302	H5
D4303	H5

OPERATION (4) P.C.B. (Side A)

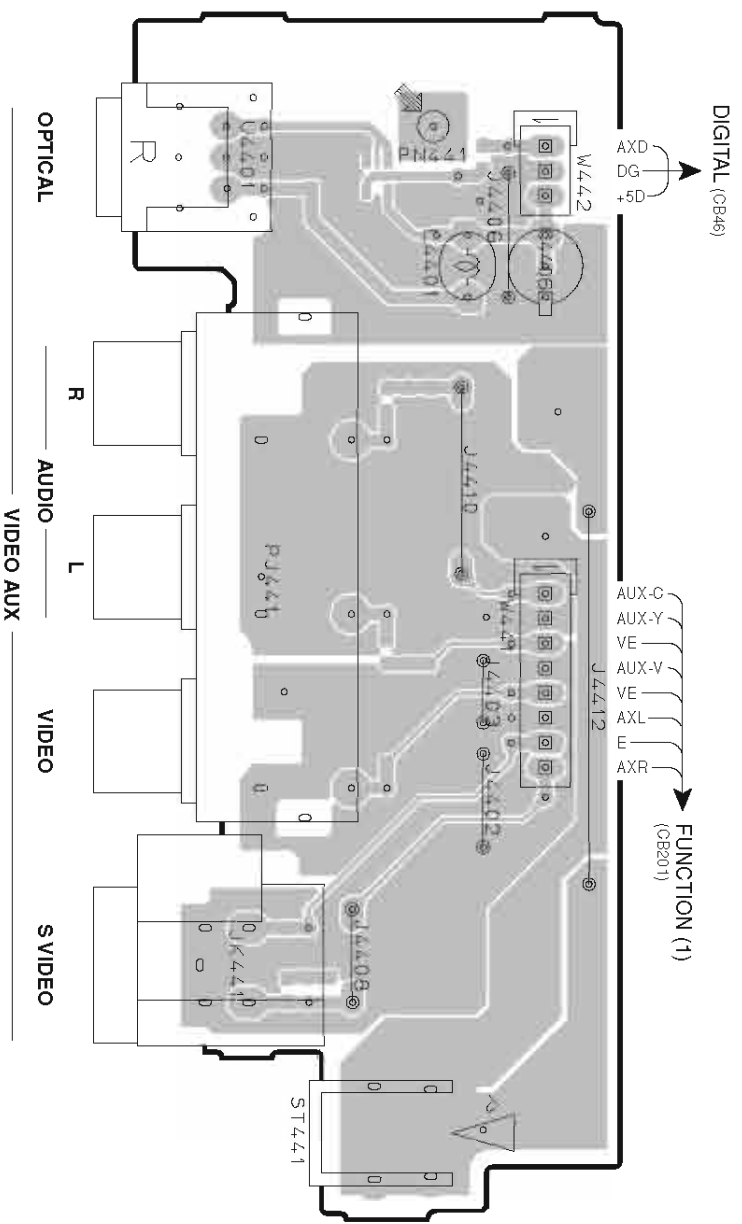

OPERATION (4) P.C.B. (Side B)

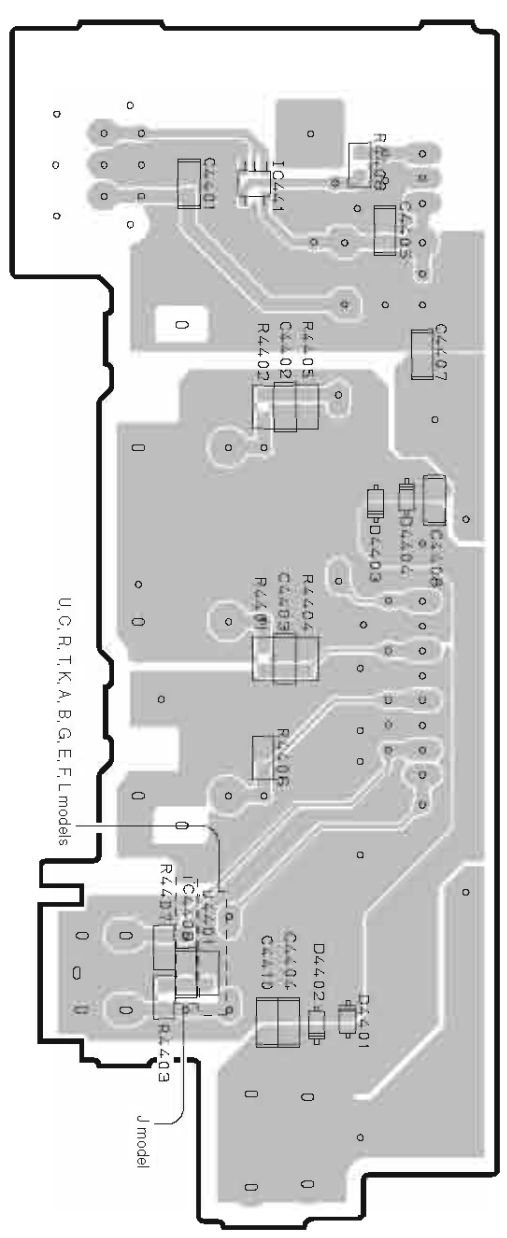

OPERATION (5) P.C.B. (Side A)

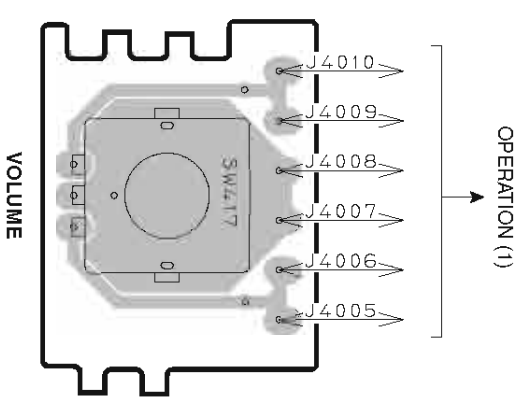

• Semiconductor Location

Ref no.	Location
D4401	I3
D4402	I3
D4403	H3
D4404	H3
IC441	G3

MAIN (1) P.C.B. (Side A)

• Semiconductor Location

Ref.no.	Location	Ref.no.	Location	Ref.no.	Location	Ref.no.	Location
D1000	C5	D1029	E4	D1065	F4	Q1026	I6
D1001	H4	D1030	E4	D1066	F4	Q1027	H6
D1002	H4	D1031	D3	D1067	C3	Q1028	G6
D1003	C5	D1032	H3	D1068	C3	Q1029	F6
D1004	I6	D1033	C3	D1069	C2	Q1030	E6
D1005	I6	D1034	D3	Q1000	C5	Q1031	C5
D1006	H6	D1035	I5	Q1001	E4	Q1032	D5
D1007	H6	D1036	I5	Q1002	E4	Q1033	I7
D1008	G6	D1037	E4	Q1003	E4	Q1034	I7
D1009	G6	D1038	E4	Q1004	D4	Q1035	I6
D1010	F6	D1039	I3	Q1005	E4	Q1036	H6
D1011	F6	D1040	H3	Q1006	H2	Q1037	H6
D1012	E6	D1043	H4	Q1007	D4	Q1038	G7
D1013	E6	D1044	H4	Q1008	E4	Q1039	G6
D1014	E6	D1045	H4	Q1009	E4	Q1040	F6
D1015	E6	D1047	D4	Q1010	E4	Q1041	F6
D1016	D5	D1048	I5	Q1011	D4	Q1042	E6
D1017	D7	D1049	D4	Q1012	E4	Q1043	E6
D1018	H6	D1050	H5	Q1013	H3	Q1044	D6
D1019	H6	D1053	I6	Q1014	D4	Q1045	C5
D1020	H6	D1054	I6	Q1015	C3	Q1046	D5
D1021	G6	D1055	H6	Q1016	C3	Q1047	C5
D1022	F6	D1056	G6	Q1019	I7	Q1048A	I7
D1023	E6	D1057	F6	Q1020	H7	Q1048C	I7
D1024	D6	D1058	E6	Q1021	G7	Q1049A	H7
D1025	D4	D1061	D6	Q1022	F7	Q1049C	H7
D1026	F4	D1062	D6	Q1023	E7	Q1050A	G7
D1027	D4	D1063	D6	Q1024	D7	Q1050C	H7
D1028	E4	D1064	C6	Q1025	I6	Q1051A	F7

DIGITAL (CB81) DIGITAL (CB82)

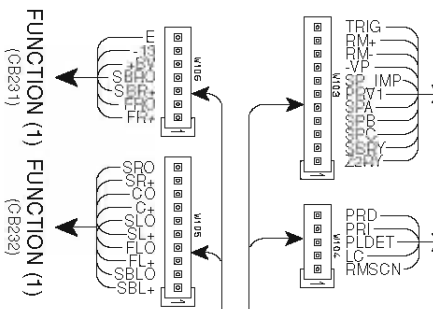

Ref.no.	Location	Ref.no.	Location	Ref.no.	Location	Ref.no.	Location
Q1051C	G7	Q1051	H6	Q1067	F4	Q1079	D6
Q1052A	E7	Q1062	G6	Q1068	H3	Q1080	C6
Q1052C	F7	Q1063	F6	Q1069	D3	Q1081A	C7
Q1053A	D7	Q1064	E6	Q1070	D3	Q1081C	D7
Q1053C	E7	Q1065	D6	Q1077	C7	Q1083	C6
Q1060	I6	Q1066	I6	Q1078	D6		

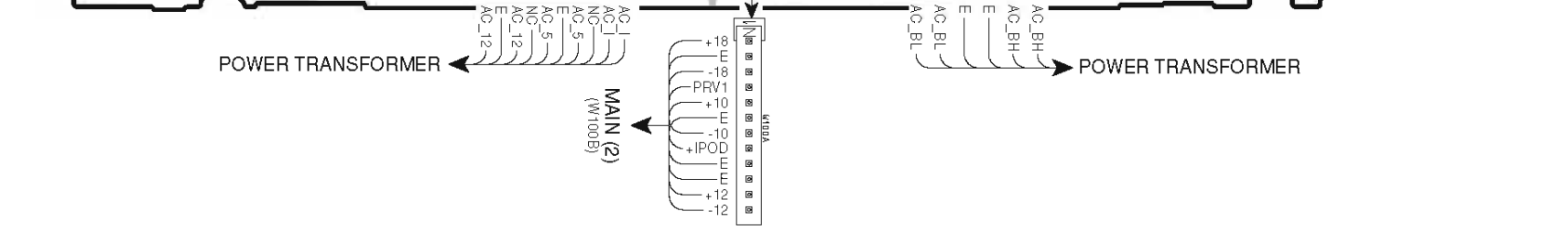
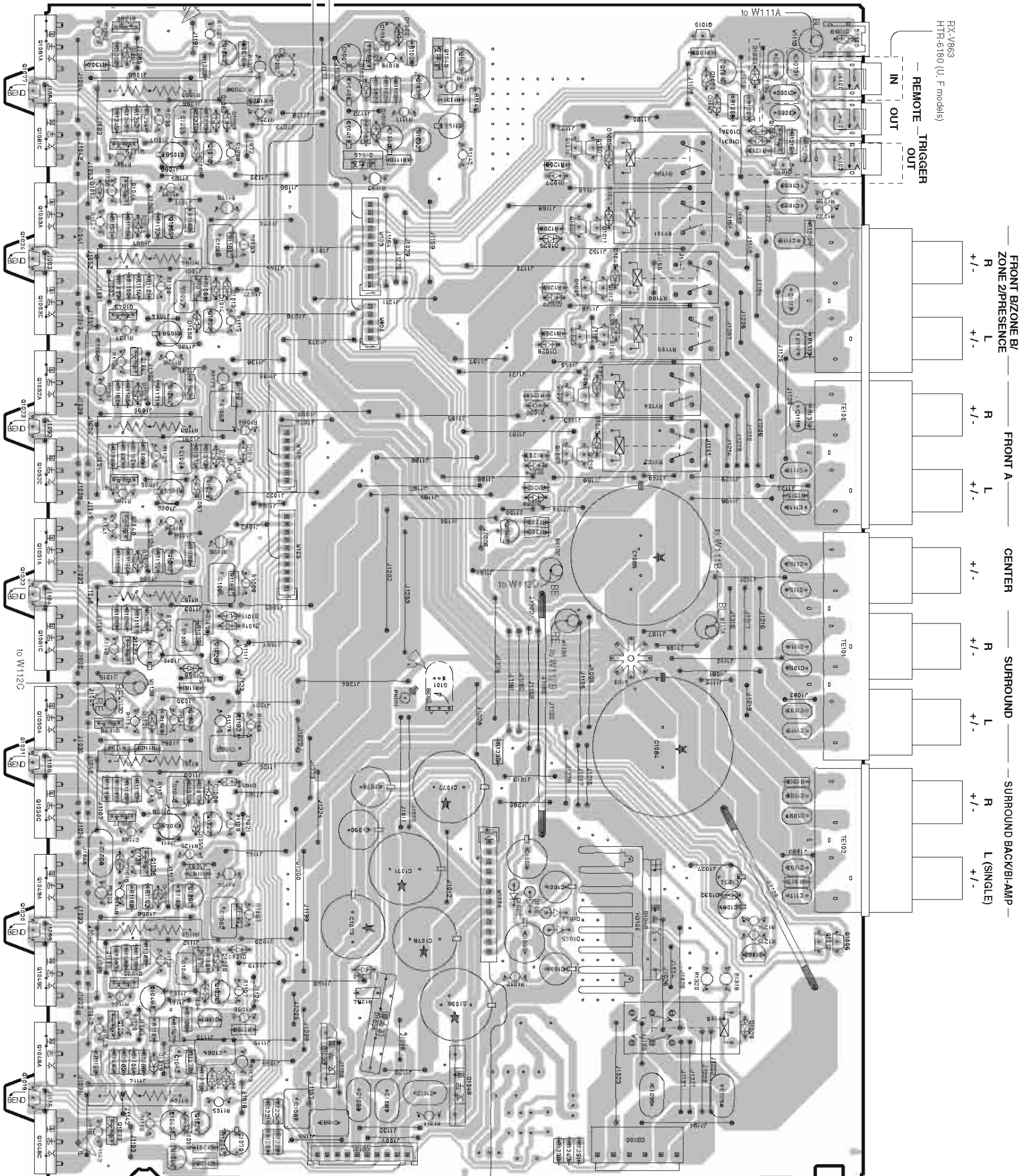

VIDEO (1) P.C.B. (Side A)

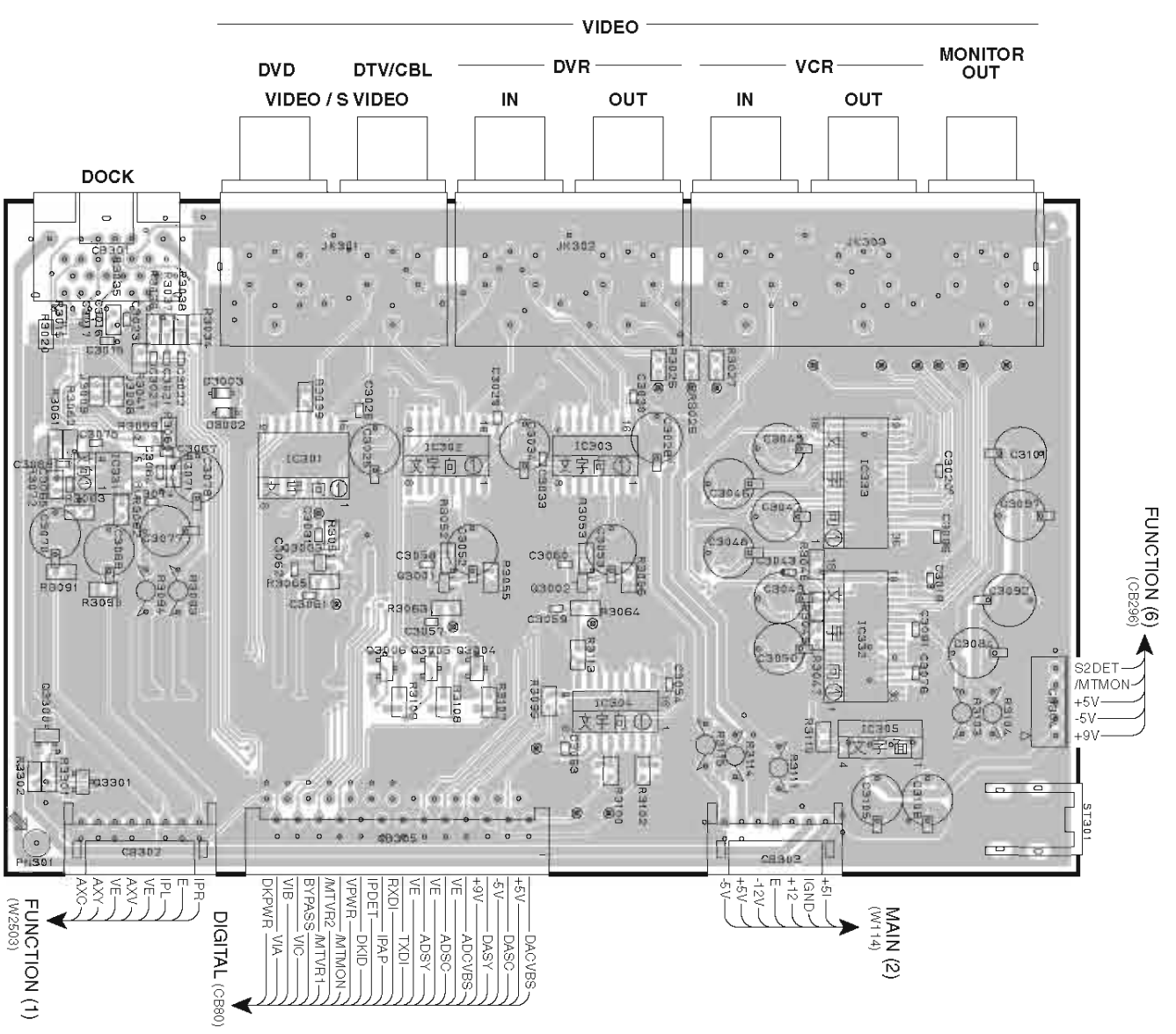

VIDEO (1) P.C.B. (Side B)

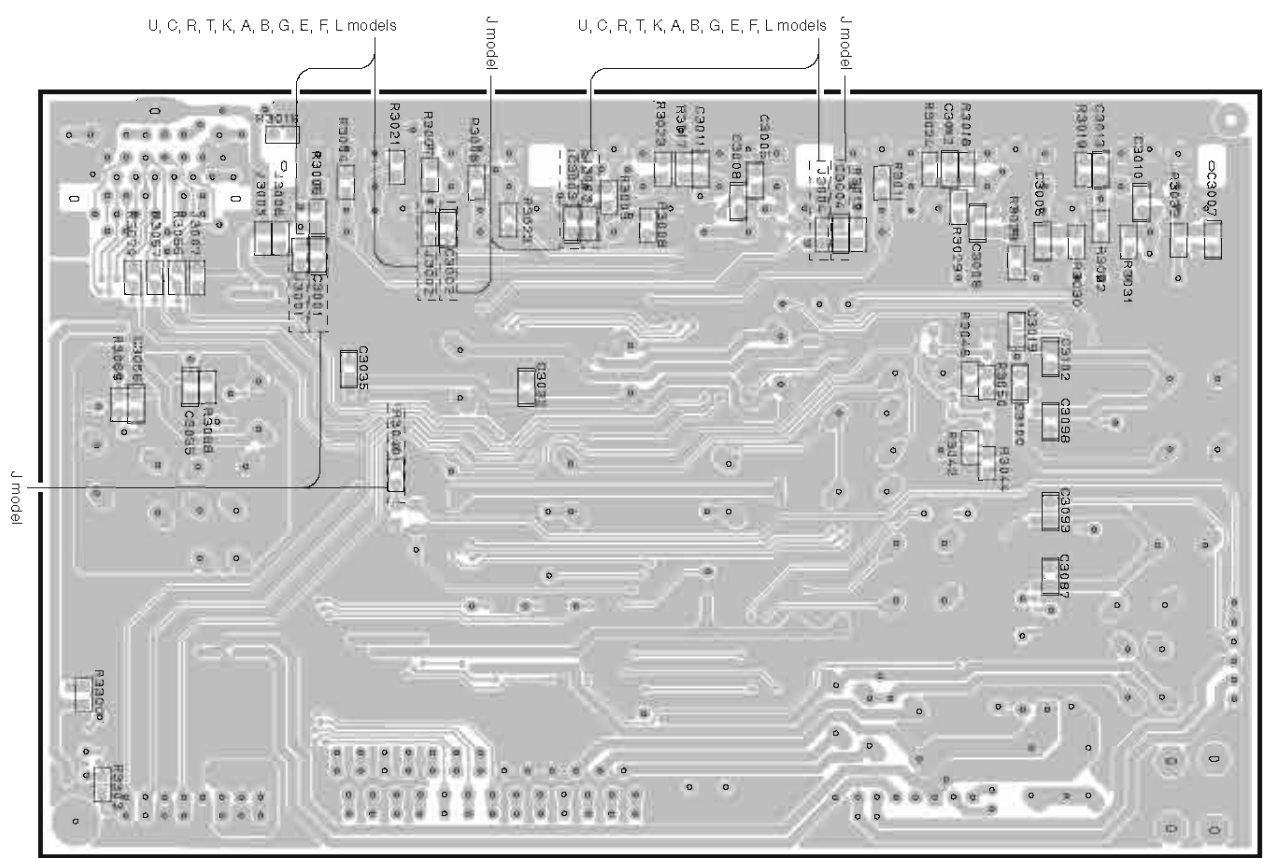

• Semiconductor Location

Ref no.	Location	Ref no.	Location
D3002	C6	IC333	C3
D3003	B6	Q3001	C5
IC301	C5	Q3002	C4
IC302	C5	Q3003	C5
IC303	C4	Q3004	D5
IC304	D4	Q3005	D5
IC305	D3	Q3006	D5
IC331	C6	Q3300	D6
IC332	C3	Q3301	D6

VIDEO (2) P.C.B. (Side A)

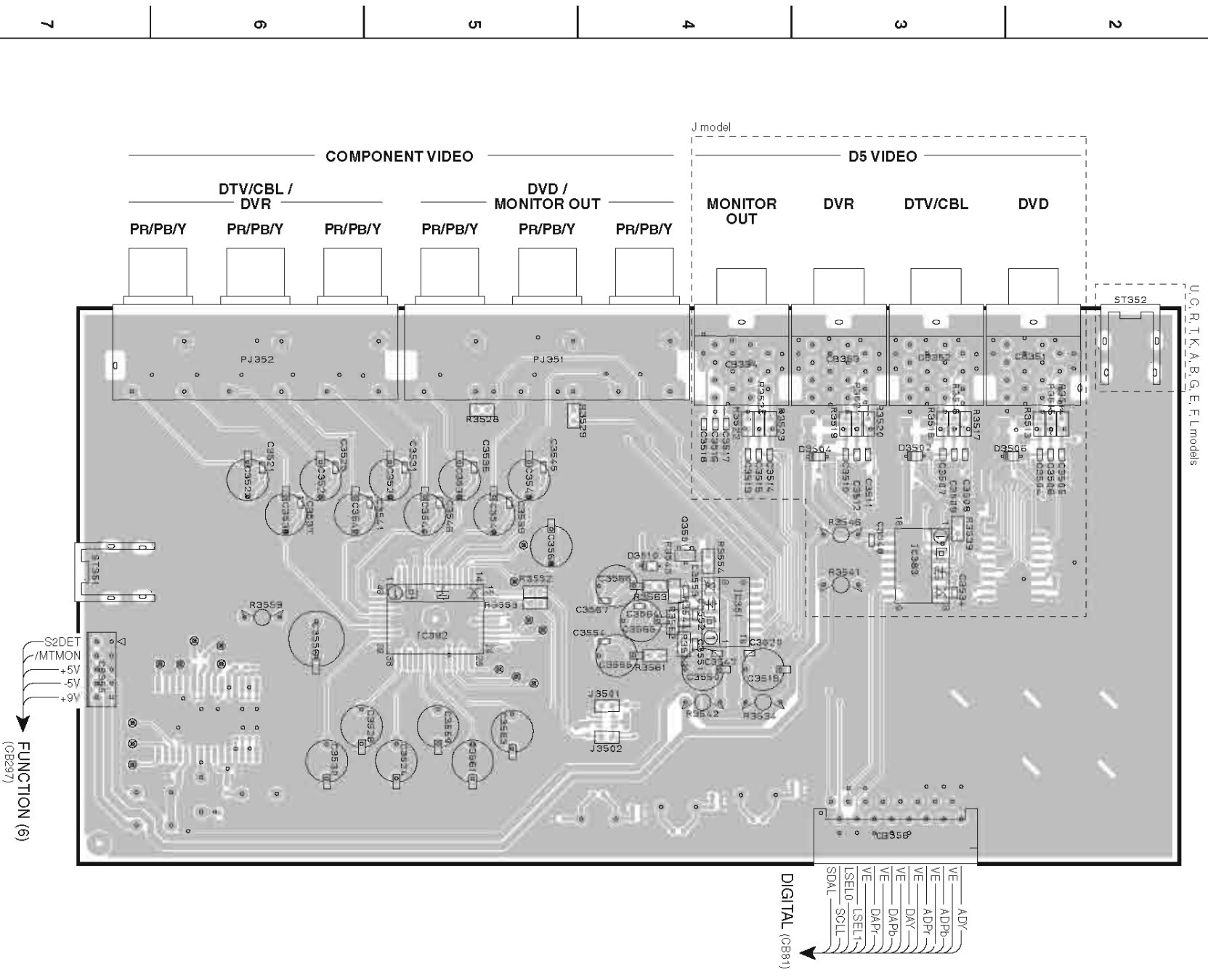

VIDEO (2) P.C.B. (Side B)

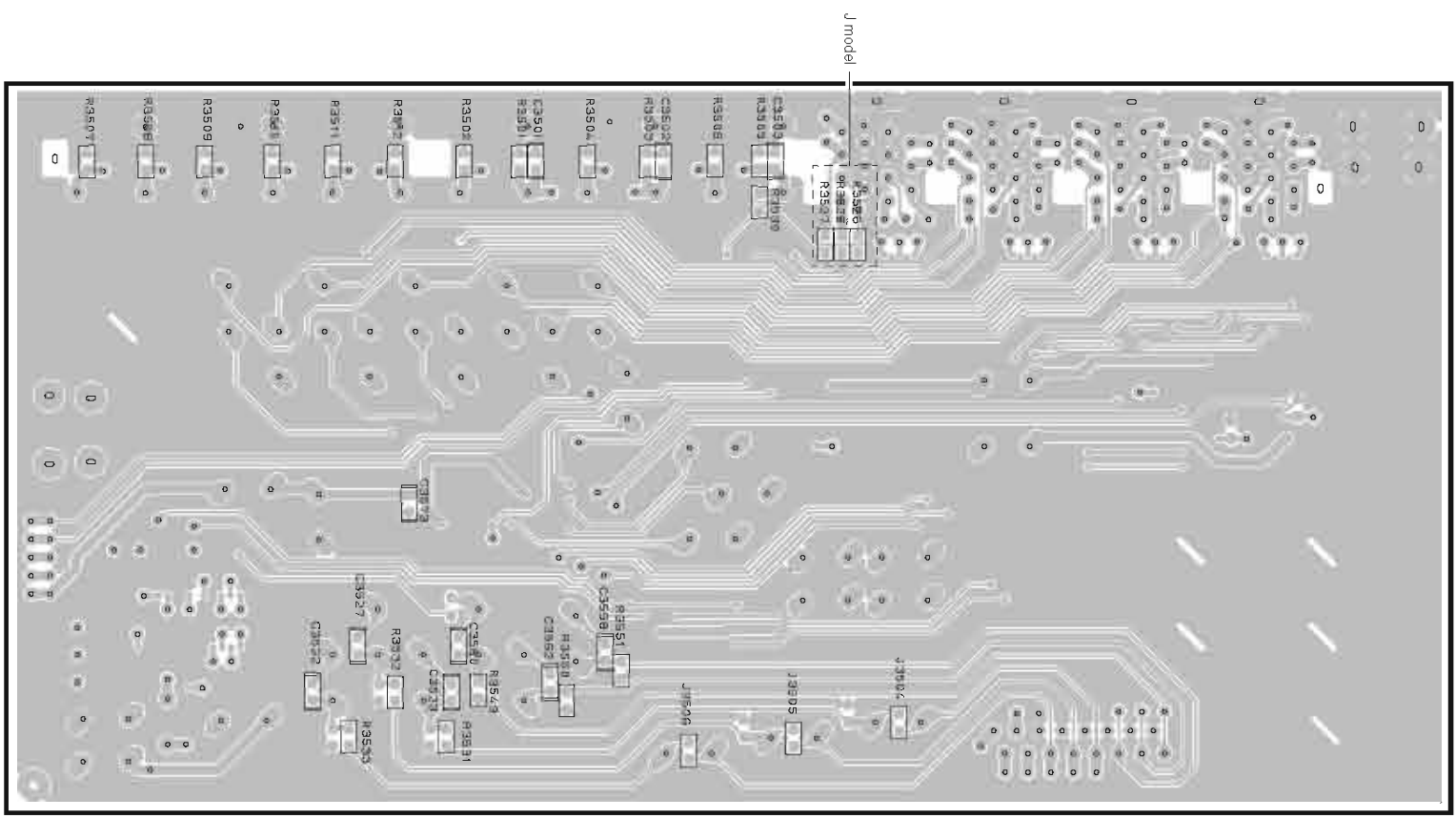

• Semiconductor Location

Ref no.	Location
D3502	C3
D3504	C3
D3506	C2
D3510	C4
IC351	C4
IC383	C3
IC392	C5
Q3501	C4

MEMO

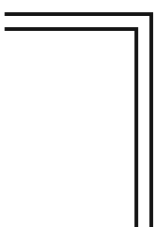
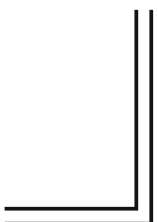

MEMO

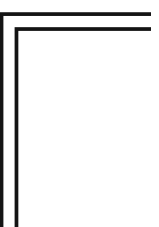
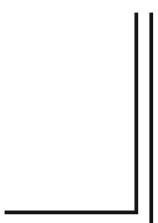

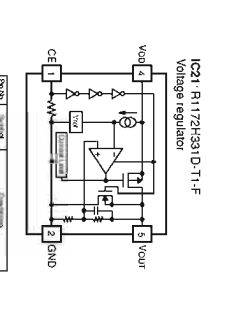
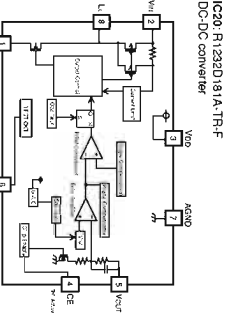
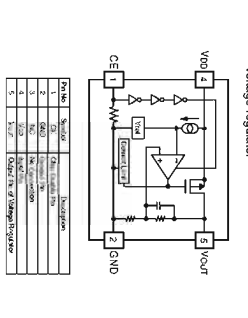
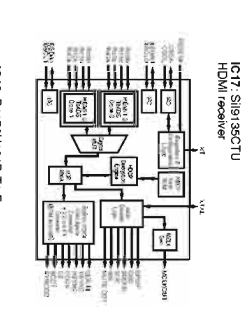
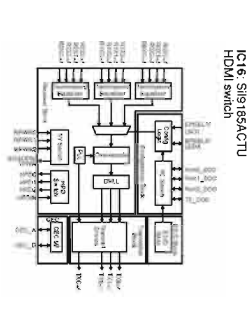
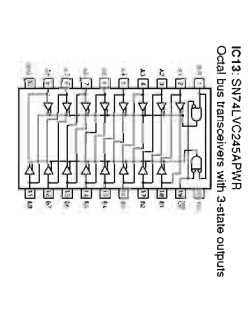
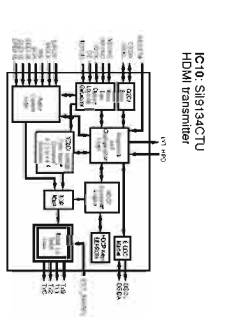
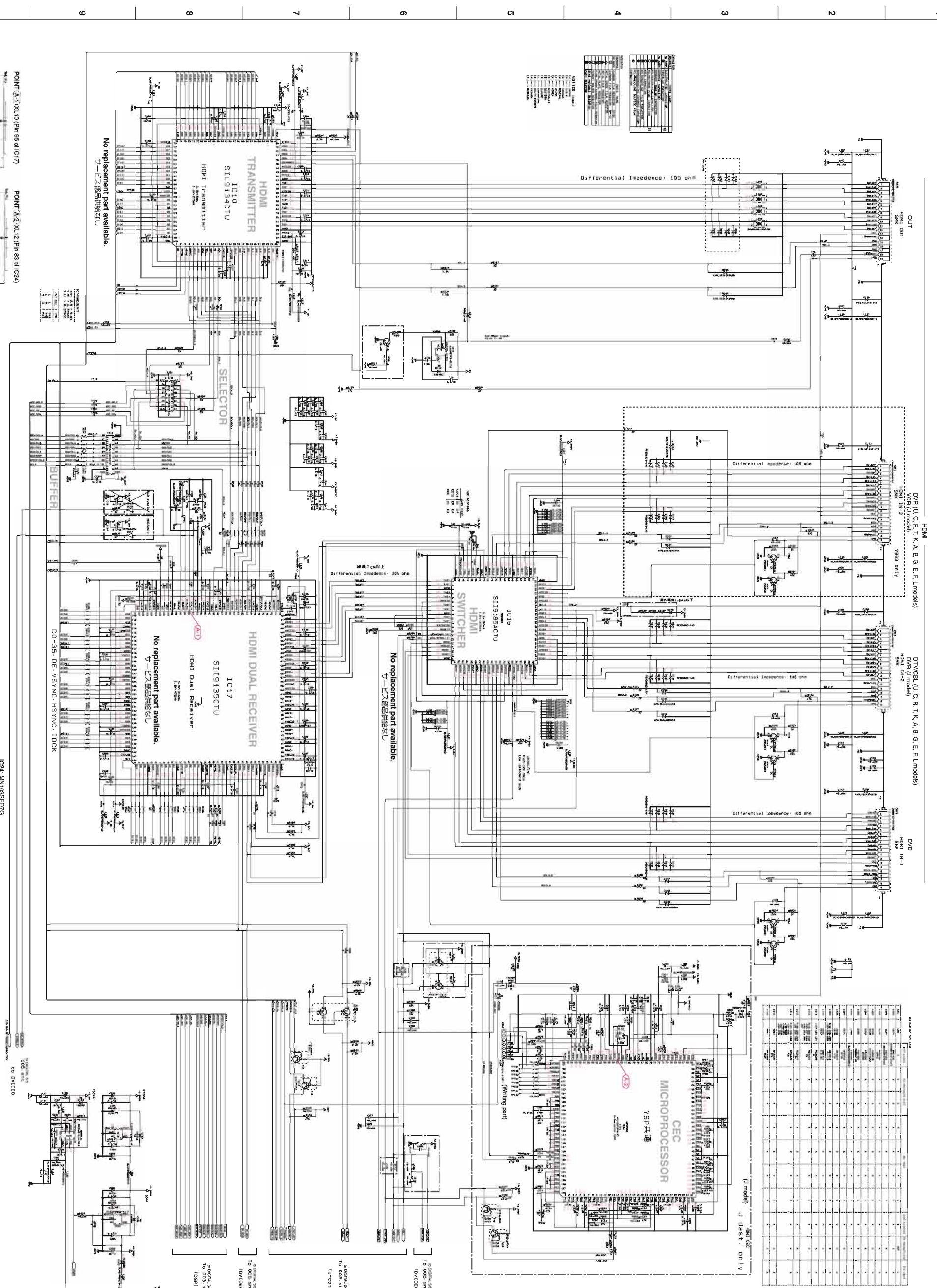

POINT A (X10) (Pin 66 of IC17)

POINT B (X12) (Pin 89 of IC24)

IC11: NJM2867F3-05
Low dropout voltage regulator

IC12: TC24VHC15FT
Quad 2-channel multiplexer

IC14: TC7SH04FU-TE96L
Inverter

IC24: M1100SFD7G
Microprocessor

● 電圧は、内部抵抗10kΩの電圧計で測定したものです。
● Aの電圧は、安全な状態で測定する必要があります。製品の交換が必要な場合、Aの電圧に近づけていく必要があります。
● Bの電圧は、安全な状態で測定する必要があります。製品の交換が必要な場合、Bの電圧に近づけていく必要があります。
● 本回路図は機密情報です。改良のため予告なく変更することがあります。

to DIGITAL 25

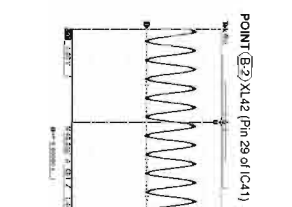
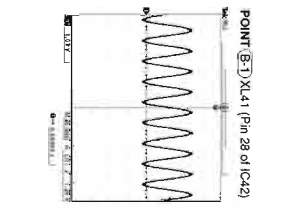
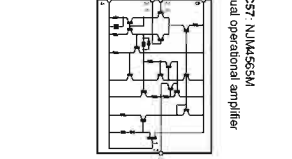
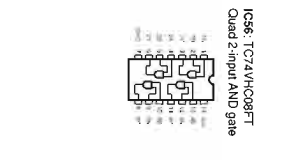
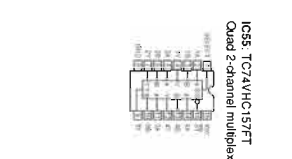
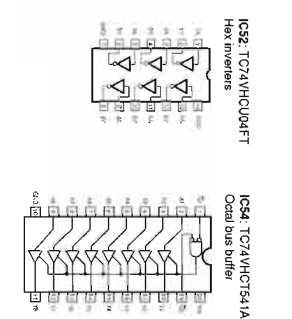
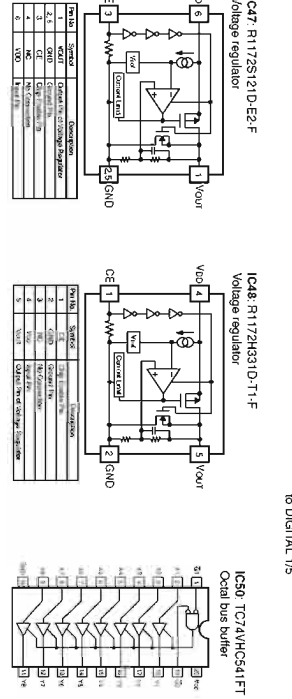
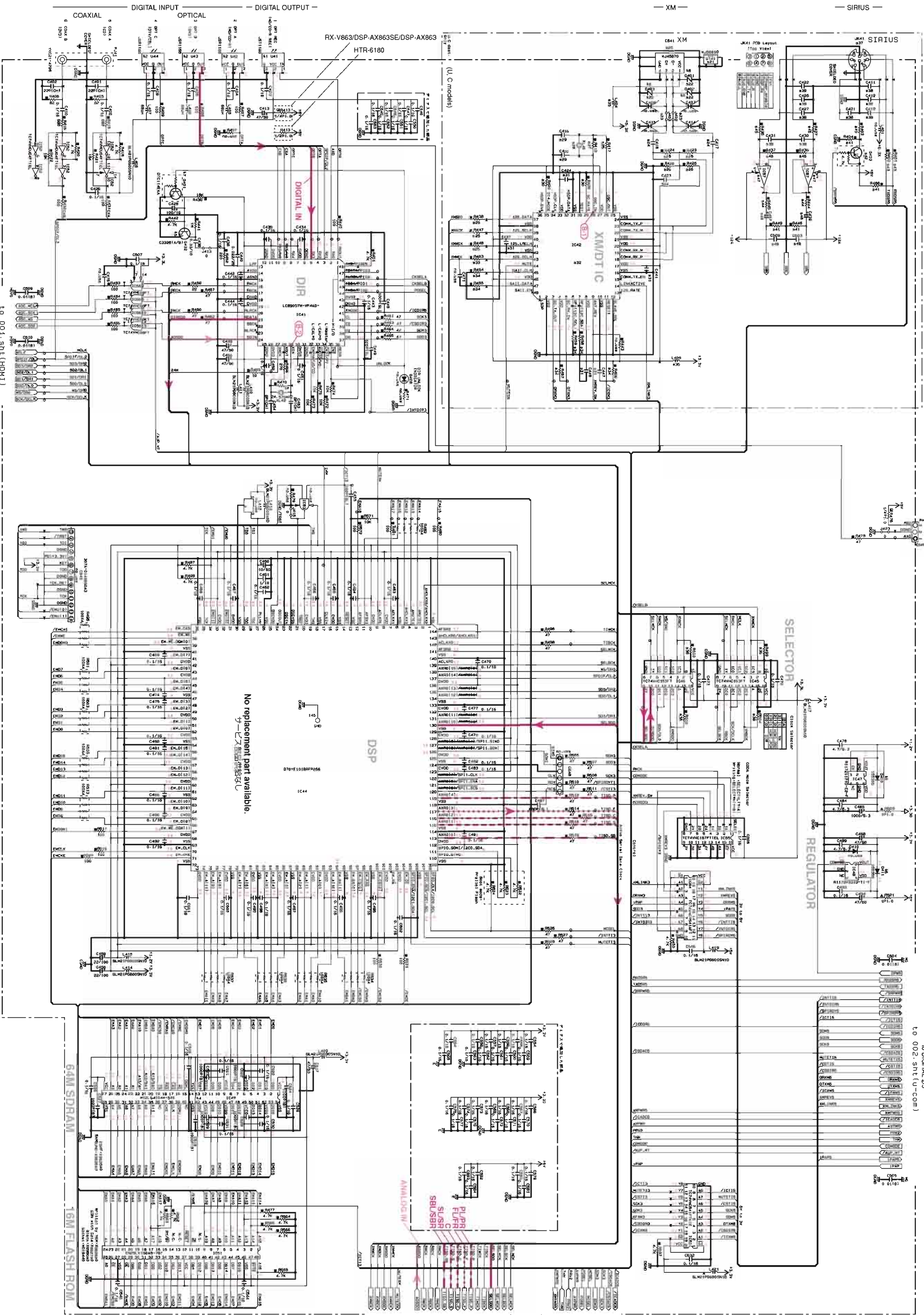

IC	Part No.	Quantity	Notes
IC47	R1172S121D-E2-F	1	Voltage regulator
IC48	R1172H331D-T1-F	1	Voltage regulator
IC50	TC7AH0541FT	1	Coaxial bus buffer
IC52	TC7AH0404FT	1	Hex inverter
IC54	TC7AH051A1FT	1	Coaxial bus buffer
IC55	TC7AH0157FT	1	Quad 2-channel multiplexer
IC56	TC7AH038FT	1	Quad 2-input AND gate
IC57	N1M455M	1	Dual operational amplifier

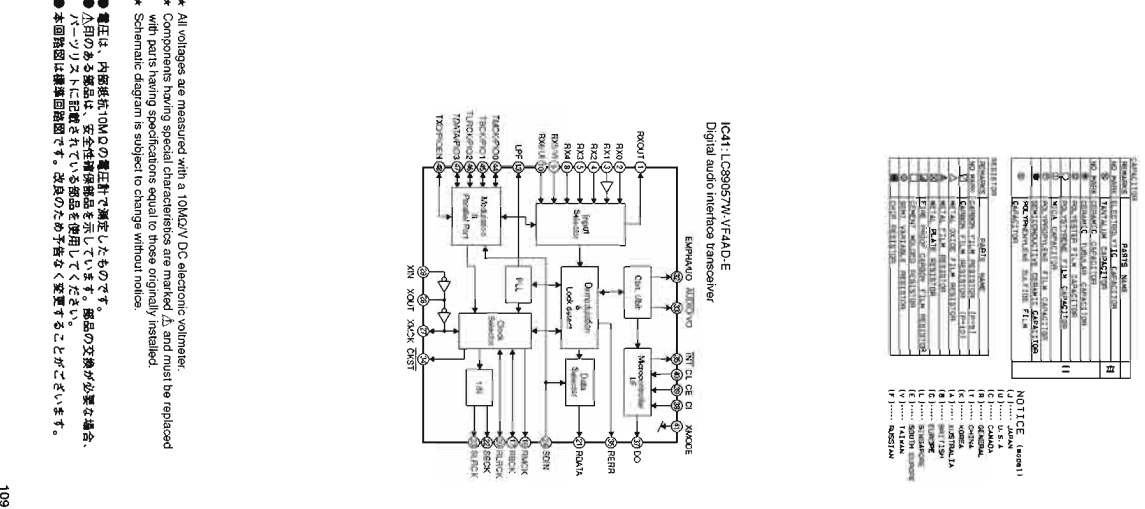

DIGITAL 4/5

Page 112 [A6]
to FUNCTION (1) CR205
to FUNC(1.1)

Page 115 [K8]
to MAIN(2) W107
to MAIN(2)

Page 114 [J9]
to OPERATION (1) W401
to OPE (1)

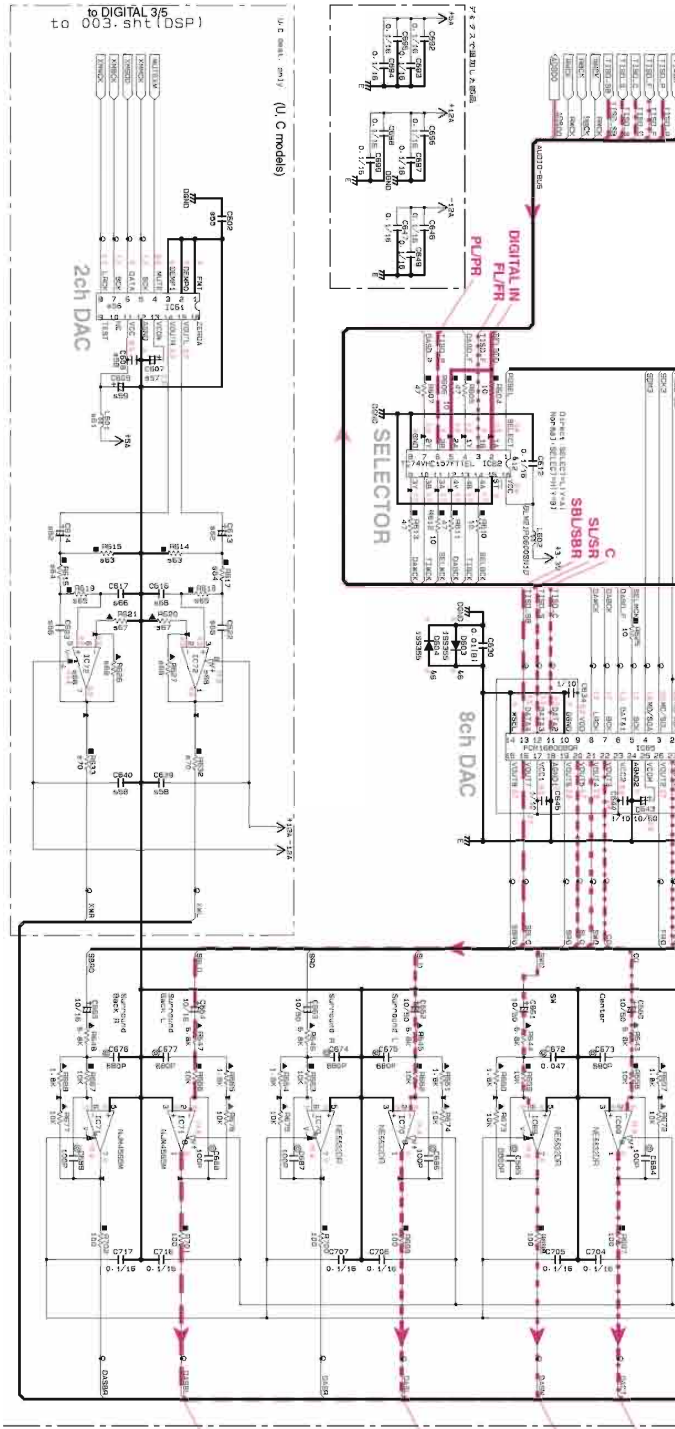
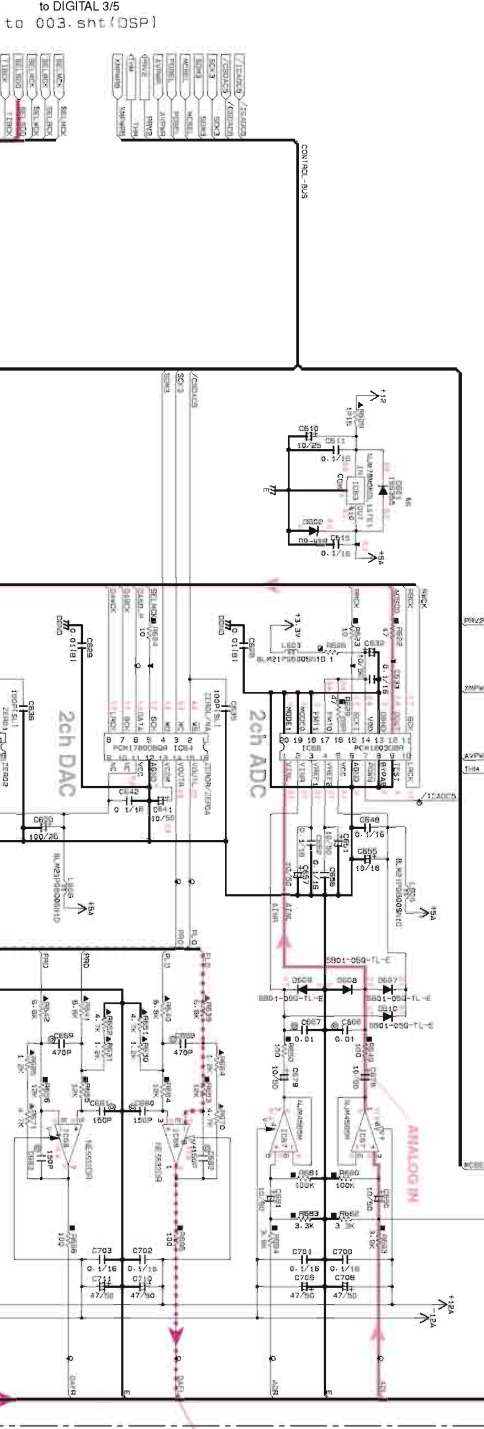
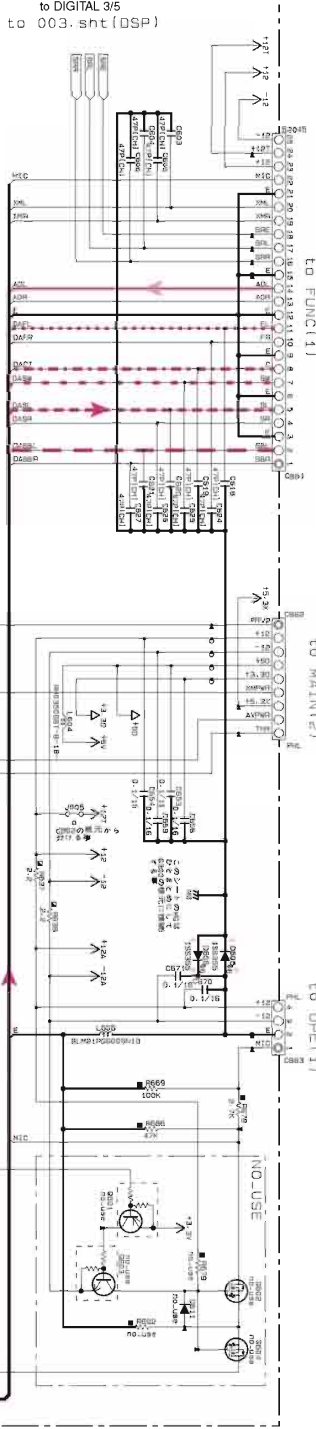

5.1 ~ 19: 002: SMT(LU-COM)
* 520 ~ 86: 004: SMT(DSP)
* 581 ~ 59: 009: SMT(DIVIDED)

Parts List Table with columns for Part No., Description, and various status indicators.

Table with columns for Part No., Description, and various status indicators.

Table with columns for Part No., Description, and various status indicators.

Table with columns for Part No., Description, and various status indicators.

NOTICE (continued)
(L) ... JAPAN
(U) ... U.S.A
(C) ... CANADA
(R) ... CHINA
(K) ... KOREA
(A) ... AUSTRALIA
(B) ... BRITISH
(I) ... INDIA
(S) ... SOUTH AFRICA
(V) ... TAIWAN
(P) ... RUSSIAN

IC BLOCK DIAGRAMS DIGITAL 3/5

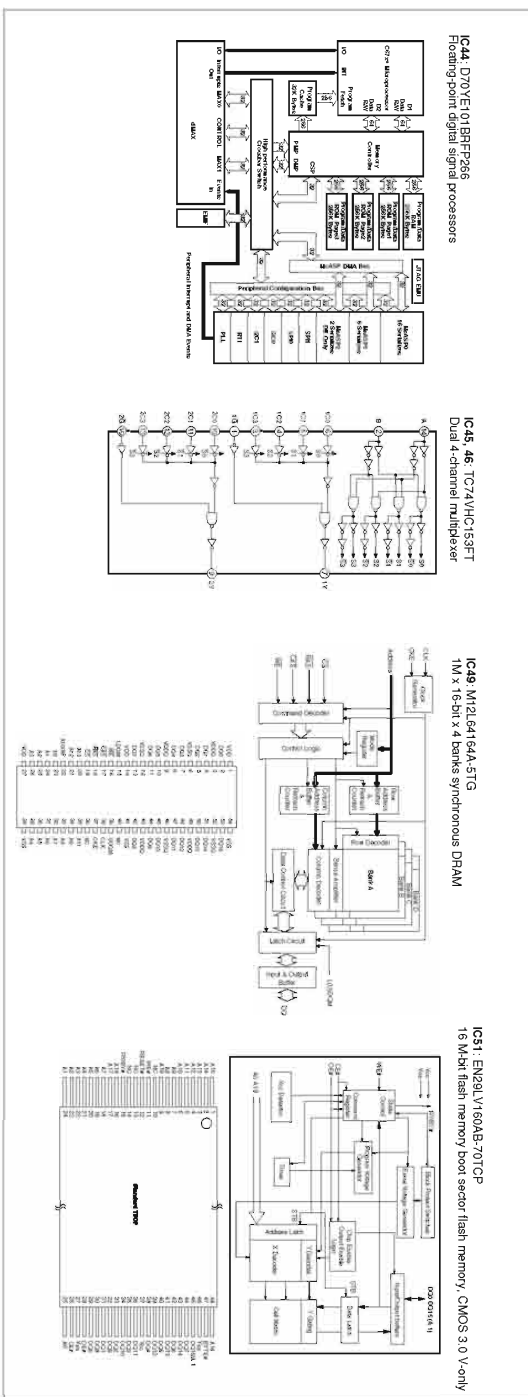

IC61: PCM1781D8DR

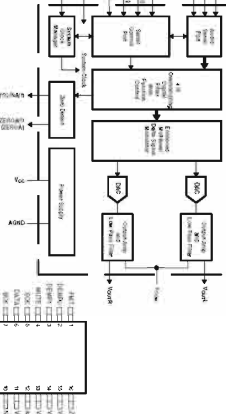

IC62: TC24MC157F



IC63: NJM78M50L1A

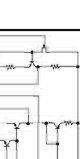

IC64: PCM1780D8DR

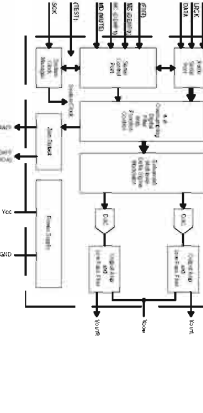

IC66: PCM1630D8R

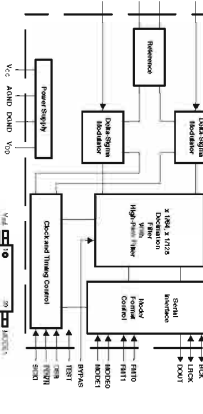

IC65: PCM1680D8DR

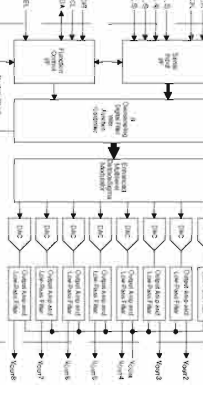

IC67: TL72

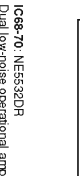

IC68: NE5532DR

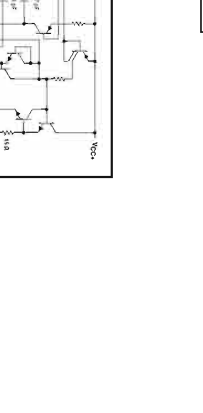

* All voltages are measured with a 10kΩV DC electronic voltmeter.
* Components having special characteristics are marked Δ and must be replaced with parts having specifications equal to those originally installed.
* Schematic diagram is subject to change without notice.

● 電圧は、内部抵抗10kΩの電圧計で測定したものです。
● Δ印のある部品は、安全性能部品を示しています。部品の交換が必要な場合、パーツに記号されている部品を使用してください。
● 本回路図は修正回路図です。改良のため予告なく変更することがあります。

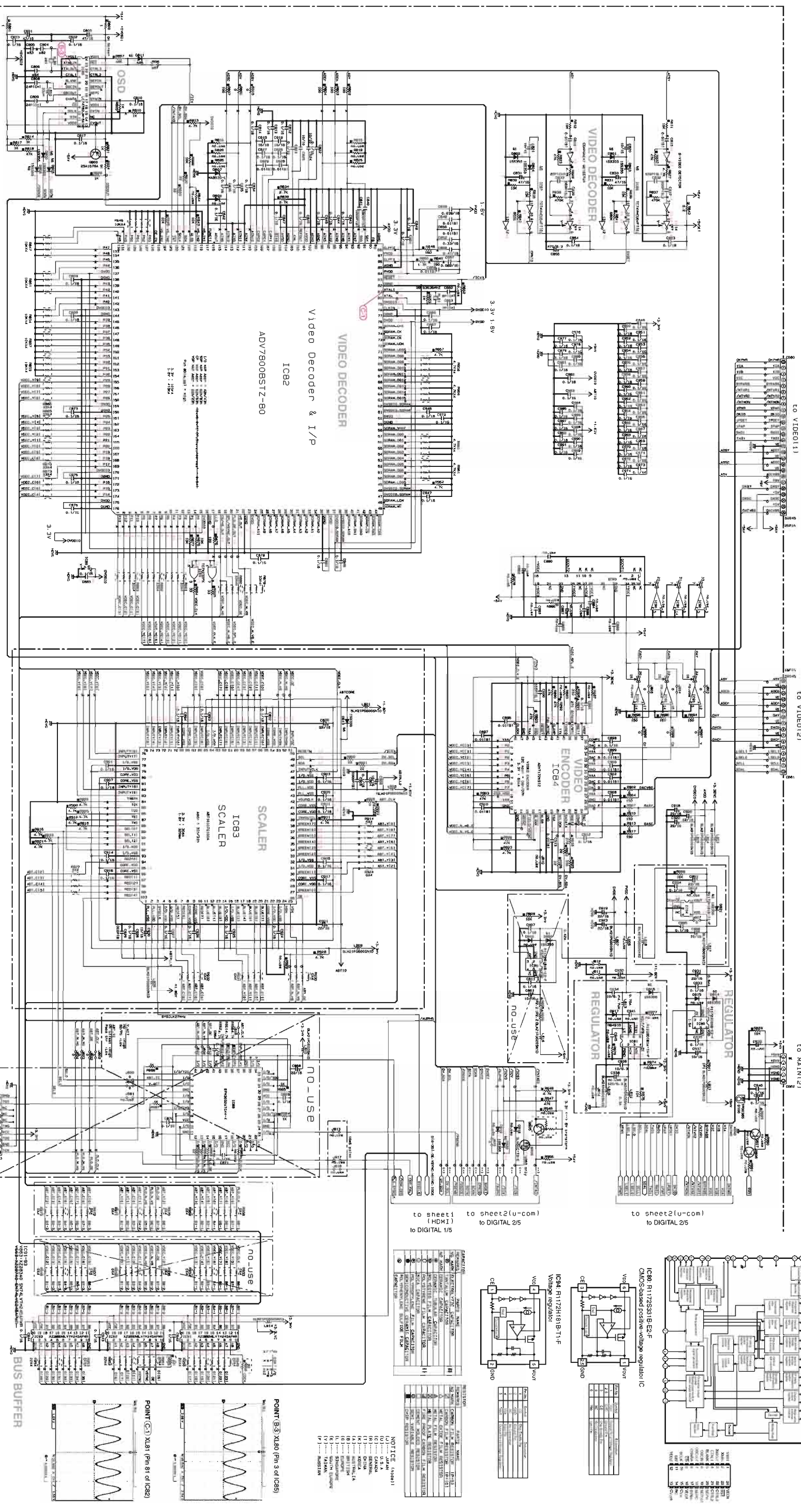

CHARACTERISTICS TABLE

NO.	ITEM	TEST CONDITION	UNIT	MIN.	TYP.	MAX.
1	Power consumption	V _{DD} = 3.3V, I _{DD} = 10mA	mW		100	150
2	Operating temperature range		°C	-20	0	70
3	Storage temperature range		°C	-40		100
4	Humidity range		%RH	5		95
5	Shock resistance		m/s	10		20
6	Vibration resistance		m/s	10		20
7	ESD resistance		kV	2		4
8	ESD resistance		kV	2		4
9	ESD resistance		kV	2		4
10	ESD resistance		kV	2		4

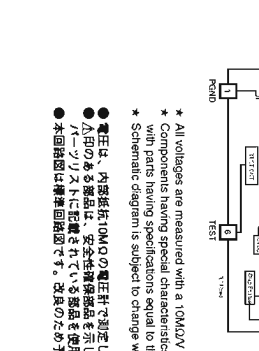
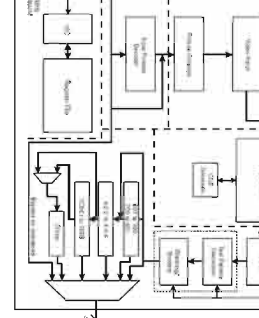
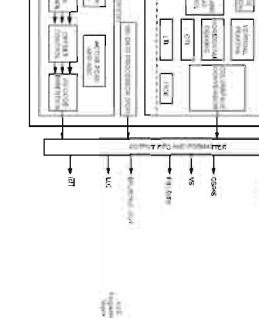
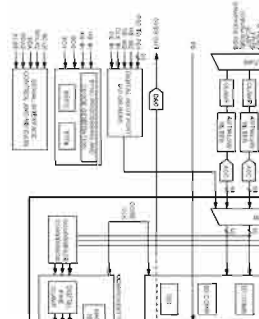
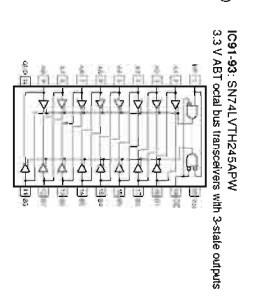
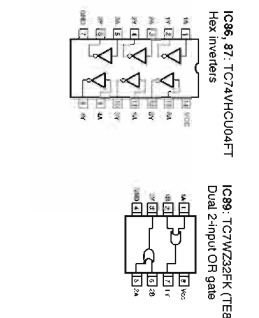
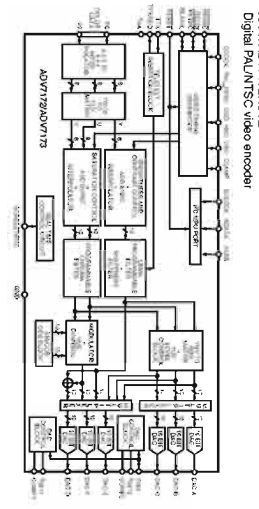

* All voltages are measured with a 10kΩV DC electronic voltmeter.
* Components having special characteristics are marked Δ, and must be replaced with parts having specifications equal to those originally installed.
* Schematic diagram is subject to change without notice.
● 端子は、内部抵抗10kΩの電圧計で測定したものです。
● Δ印のある部品は、特別な特性を示しています。部品の交換が必要な場合、Δ印の入った同等品を使用してください。
● 本回路図は仕様変更の可能性があります。

FUNCTION 2/2

Page 112 [G6]
to FUNCTION (1) CB246

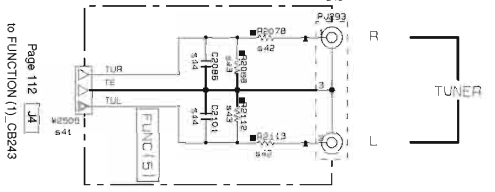
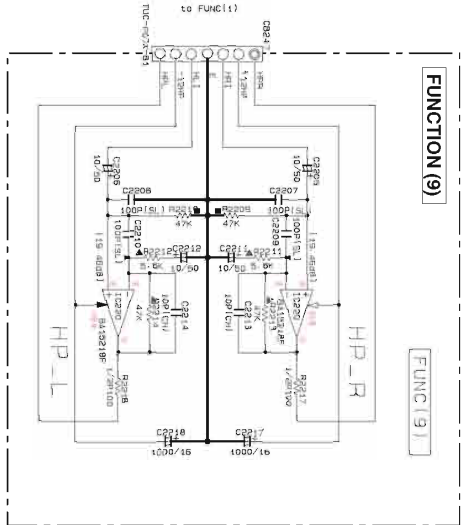

RESISTOR	PARTS NAME	REMARKS
NO MARK	ELECTRICAL TPC CAPACITOR	#
NO MARK	TRIMMER CAPACITOR	#
NO MARK	CRYSTAL TUBULAR CAPACITOR	#
NO MARK	ORGANIC TUBULAR CAPACITOR	#
NO MARK	ORGANIC FILM CAPACITOR	#
NO MARK	MIL CAPACITOR	#
NO MARK	POLYPROPYLENE FILM CAPACITOR	#
NO MARK	SPRAY CONDUCTIVE CERAMIC CAPACITOR	#
NO MARK	RESISTOR	#
NO MARK	CARBON FILM RESISTOR (P=10)	#
NO MARK	CARBON FILM RESISTOR (P=10)	#
NO MARK	METAL OXIDE FILM RESISTOR	#
NO MARK	METAL FILM RESISTOR	#
NO MARK	PRECISION FILM RESISTOR	#
NO MARK	CURRENT MONITOR RESISTOR	#
NO MARK	SMALL VARIABLE RESISTOR	#
NO MARK	CHIP RESISTOR	#

NOTICE (Import)
 (U) ... U.S.A.
 (C) ... CANADA
 (A) ... AUSTRALIA
 (T) ... TAIWAN
 (K) ... KOREA
 (A) ... AUSTRALIA
 (B) ... BRITISH
 (G) ... GERMANY
 (L) ... LONDON
 (E) ... EUROPE
 (S) ... SOUTH AFRICA
 (V) ... SOUTH AFRICA
 (F) ... FRANCE

Page 116 [K5]
to VIDEO (1) CB804

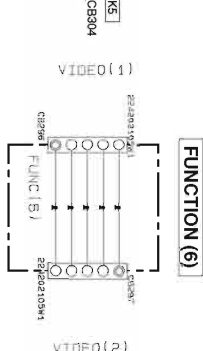

Page 117 [Z7]
to VIDEO (2) CB855

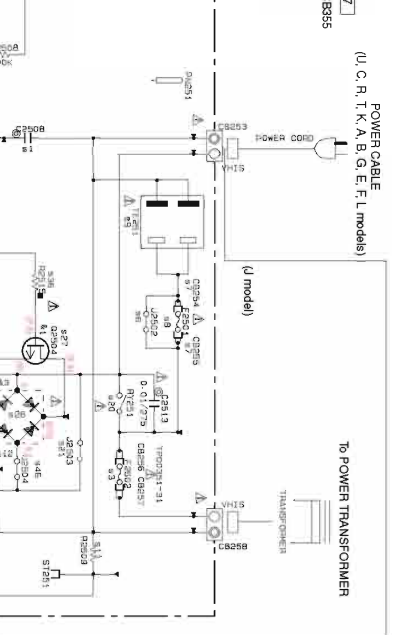

Page 115 [K8]
to MAIN (2) W108

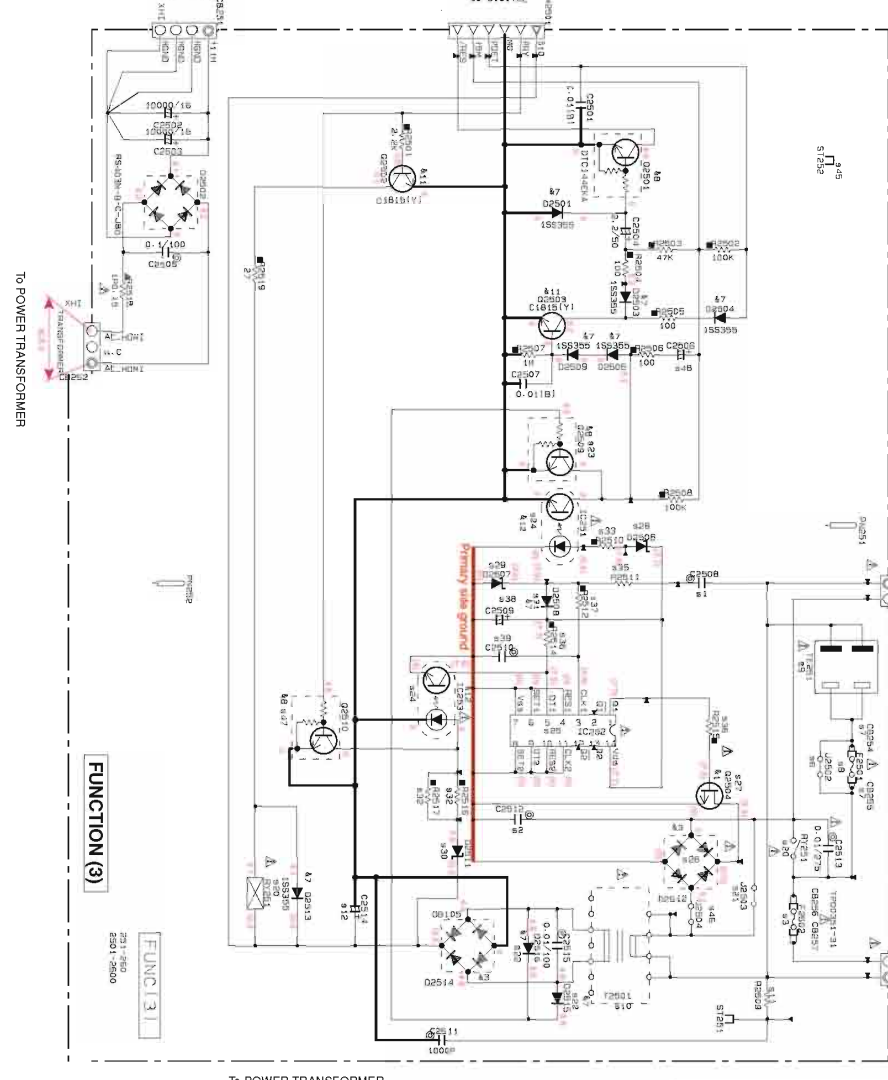

Page 118 [F2]
to DIGITAL_CB33

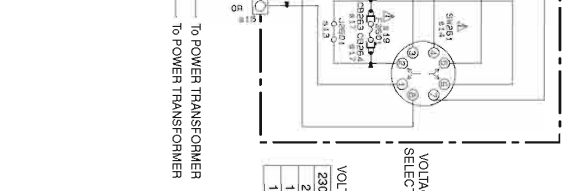

VOLTAGE SELECTOR	RESISTOR VALUE
230-240V	1.25-6
220V	2.38-7
110V	3.47-8
120V	4.56-1

SIC	LOC	U	U	N	C	F	A	B	DEF	L	K
51	CR10	W48180	X	W48180	X	W48180	X	W48180	X	W48180	X
52	CR11	W48180	X	W48180	X	W48180	X	W48180	X	W48180	X
53	CR12	W48180	X	W48180	X	W48180	X	W48180	X	W48180	X
54	CR13	W48180	X	W48180	X	W48180	X	W48180	X	W48180	X
55	CR14	W48180	X	W48180	X	W48180	X	W48180	X	W48180	X
56	CR15	W48180	X	W48180	X	W48180	X	W48180	X	W48180	X
57	CR16	W48180	X	W48180	X	W48180	X	W48180	X	W48180	X
58	CR17	W48180	X	W48180	X	W48180	X	W48180	X	W48180	X
59	CR18	W48180	X	W48180	X	W48180	X	W48180	X	W48180	X
60	CR19	W48180	X	W48180	X	W48180	X	W48180	X	W48180	X
61	CR20	W48180	X	W48180	X	W48180	X	W48180	X	W48180	X
62	CR21	W48180	X	W48180	X	W48180	X	W48180	X	W48180	X
63	CR22	W48180	X	W48180	X	W48180	X	W48180	X	W48180	X
64	CR23	W48180	X	W48180	X	W48180	X	W48180	X	W48180	X
65	CR24	W48180	X	W48180	X	W48180	X	W48180	X	W48180	X
66	CR25	W48180	X	W48180	X	W48180	X	W48180	X	W48180	X
67	CR26	W48180	X	W48180	X	W48180	X	W48180	X	W48180	X
68	CR27	W48180	X	W48180	X	W48180	X	W48180	X	W48180	X
69	CR28	W48180	X	W48180	X	W48180	X	W48180	X	W48180	X
70	CR29	W48180	X	W48180	X	W48180	X	W48180	X	W48180	X
71	CR30	W48180	X	W48180	X	W48180	X	W48180	X	W48180	X
72	CR31	W48180	X	W48180	X	W48180	X	W48180	X	W48180	X
73	CR32	W48180	X	W48180	X	W48180	X	W48180	X	W48180	X
74	CR33	W48180	X	W48180	X	W48180	X	W48180	X	W48180	X
75	CR34	W48180	X	W48180	X	W48180	X	W48180	X	W48180	X
76	CR35	W48180	X	W48180	X	W48180	X	W48180	X	W48180	X
77	CR36	W48180	X	W48180	X	W48180	X	W48180	X	W48180	X
78	CR37	W48180	X	W48180	X	W48180	X	W48180	X	W48180	X
79	CR38	W48180	X	W48180	X	W48180	X	W48180	X	W48180	X
80	CR39	W48180	X	W48180	X	W48180	X	W48180	X	W48180	X
81	CR40	W48180	X	W48180	X	W48180	X	W48180	X	W48180	X
82	CR41	W48180	X	W48180	X	W48180	X	W48180	X	W48180	X
83	CR42	W48180	X	W48180	X	W48180	X	W48180	X	W48180	X
84	CR43	W48180	X	W48180	X	W48180	X	W48180	X	W48180	X
85	CR44	W48180	X	W48180	X	W48180	X	W48180	X	W48180	X
86	CR45	W48180	X	W48180	X	W48180	X	W48180	X	W48180	X
87	CR46	W48180	X	W48180	X	W48180	X	W48180	X	W48180	X
88	CR47	W48180	X	W48180	X	W48180	X	W48180	X	W48180	X
89	CR48	W48180	X	W48180	X	W48180	X	W48180	X	W48180	X
90	CR49	W48180	X	W48180	X	W48180	X	W48180	X	W48180	X
91	CR50	W48180	X	W48180	X	W48180	X	W48180	X	W48180	X
92	CR51	W48180	X	W48180	X	W48180	X	W48180	X	W48180	X
93	CR52	W48180	X	W48180	X	W48180	X	W48180	X	W48180	X
94	CR53	W48180	X	W48180	X	W48180	X	W48180	X	W48180	X
95	CR54	W48180	X	W48180	X	W48180	X	W48180	X	W48180	X
96	CR55	W48180	X	W48180	X	W48180	X	W48180	X	W48180	X
97	CR56	W48180	X	W48180	X	W48180	X	W48180	X	W48180	X
98	CR57	W48180	X	W48180	X	W48180	X	W48180	X	W48180	X
99	CR58	W48180	X	W48180	X	W48180	X	W48180	X	W48180	X
100	CR59	W48180	X	W48180	X	W48180	X	W48180	X	W48180	X
101	CR60	W48180	X	W48180	X	W48180	X	W48180	X	W48180	X
102	CR61	W48180	X	W48180	X	W48180	X	W48180	X	W48180	X
103	CR62	W48180	X	W48180	X	W48180	X	W48180	X	W48180	X
104	CR63	W48180	X	W48180	X	W48180	X	W48180	X	W48180	X
105	CR64	W48180	X	W48180	X	W48180	X	W48180	X	W48180	X
106	CR65	W48180	X	W48180	X	W48180	X	W48180	X	W48180	X
107	CR66	W48180	X	W48180	X	W48180	X	W48180	X	W48180	X
108	CR67	W48180	X	W48180	X	W48180	X	W48180	X	W48180	X
109	CR68	W48180	X	W48180	X	W48180	X	W48180	X	W48180	X
110	CR69	W48180	X	W48180	X	W48180	X	W48180	X	W48180	X
111	CR70	W48180	X	W48180	X	W48180	X	W48180	X	W48180	X
112	CR71	W48180	X	W48180	X	W48180	X	W48180	X	W48180	X
113	CR72	W48180	X	W48180	X	W48180	X	W48180	X	W48180	X
114	CR73	W48180	X	W48180	X	W48180	X	W48180	X	W48180	X
115	CR74	W48180	X	W48180	X	W48180	X	W48180	X	W48180	X
116	CR75	W48180	X	W48180	X	W48180	X	W48180	X	W48180	X
117	CR76	W48180	X	W48180	X	W48180	X	W48180	X	W48180	X
118	CR77	W48180	X	W48180	X	W48180	X	W48180	X	W48180	X
119	CR78	W48180	X	W48180	X	W48180	X	W48180	X	W48180	X
120	CR79	W48180	X	W48180	X	W48180	X	W48180	X	W48180	X
121	CR80	W48180	X	W48180	X	W48180	X	W48180	X	W48180	X
122	CR81	W48180	X	W48180	X	W48180	X	W48180	X	W48180	X
123	CR82	W48180	X	W48180	X	W48180	X	W48180	X	W48180	X
124	CR83	W48180	X	W48180	X	W48180	X	W48180	X	W48180	X
125	CR84	W48180	X	W48180	X	W48180	X	W48180	X	W48180	X
126	CR85	W48180	X	W48180	X	W48180	X	W48180	X	W48180	X
127	CR86	W48180	X	W48180	X	W48180	X	W48180	X	W48180	X
128	CR87	W48180	X	W48180	X	W48180	X	W48180	X	W48180	X
129	CR88	W48180	X	W48180	X	W48180	X	W48180	X	W48180	X
130	CR89	W48180	X	W48180	X	W48180	X	W48180	X	W48180	X
131	CR90	W48180	X	W48180	X	W48180	X	W48180	X	W48180	X
132	CR91	W48180	X	W48180	X	W48180	X	W48180	X	W48180	X
133	CR92	W48180	X	W48180	X	W48180	X	W48180	X	W48180	X
134	CR93	W48180	X	W48180	X	W48180	X	W48180	X	W48180	X
135	CR94	W48180	X	W48180	X	W48180	X	W48180	X	W48180	X
136	CR95	W48180	X	W48180	X	W48180	X	W48180	X	W48180	X
137	CR96	W48180	X	W48180	X	W48180	X	W48180	X	W48180	X
138	CR97	W48180	X	W48180	X	W48180	X	W48180	X	W48180	X
139	CR98	W48180	X	W48180	X	W48180	X	W48180	X	W48180	X
140	CR99	W48180	X	W48180	X	W48180	X	W48180	X	W48180	X
141	CR100	W48180	X	W48180	X	W48180	X	W48180	X	W48180	X

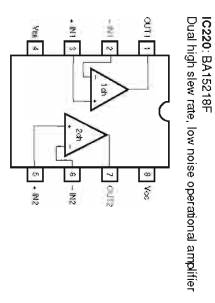

OPERATION

REMARKS	PARTS NAME
NO MARK	CARBON FILM RESISTOR (P-51)
△	METAL OXIDE FILM RESISTOR
▲	METAL FLAKE RESISTOR
□	FILM PROOF CARBON FILM RESISTOR
○	CERAMIC MOLDED RESISTOR
◎	SEMI VARIABLE RESISTOR
⊙	CHIP RESISTOR

REMARKS	PARTS NAME
○	ELECTROLYTIC CAPACITOR
○	TANTALUM CAPACITOR
(R)	CERAMIC TANTALUM CAPACITOR
(K)	POLYESTER FILM CAPACITOR
(A)	AUSTRIAN POLYESTER FILM CAPACITOR
(B)	POLYESTER FILM CAPACITOR
(E)	POLYPROPYLENE FILM CAPACITOR
(L)	POLYPROPYLENE FILM CAPACITOR
(V)	SOUTH EUROPE
(T)	TAIWAN
(F)	PURSIAN

NOTICE (model)

- (J)..... JAPAN
- (U)..... U.S.A
- (C)..... CANADA
- (R)..... GENERAL
- (Y)..... CHINA
- (K)..... KOREA
- (A)..... AUSTRALIA
- (B)..... BRITISH
- (E)..... EUROPE
- (L)..... SINGAPORE
- (V)..... SOUTH EUROPE
- (T)..... TAIWAN
- (F)..... PURSIAN

Destination Part List

LOC	REVISED	QTY	DESCRIPTION	REVISED	QTY	DESCRIPTION
4002	4002A	1	RESISTOR	4002	1	RESISTOR
4003	4003A	1	RESISTOR	4003	1	RESISTOR
4004	4004A	1	RESISTOR	4004	1	RESISTOR
4005	4005A	1	RESISTOR	4005	1	RESISTOR
4006	4006A	1	RESISTOR	4006	1	RESISTOR
4007	4007A	1	RESISTOR	4007	1	RESISTOR
4008	4008A	1	RESISTOR	4008	1	RESISTOR
4009	4009A	1	RESISTOR	4009	1	RESISTOR
4010	4010A	1	RESISTOR	4010	1	RESISTOR
4011	4011A	1	RESISTOR	4011	1	RESISTOR
4012	4012A	1	RESISTOR	4012	1	RESISTOR
4013	4013A	1	RESISTOR	4013	1	RESISTOR
4014	4014A	1	RESISTOR	4014	1	RESISTOR
4015	4015A	1	RESISTOR	4015	1	RESISTOR
4016	4016A	1	RESISTOR	4016	1	RESISTOR
4017	4017A	1	RESISTOR	4017	1	RESISTOR
4018	4018A	1	RESISTOR	4018	1	RESISTOR
4019	4019A	1	RESISTOR	4019	1	RESISTOR
4020	4020A	1	RESISTOR	4020	1	RESISTOR
4021	4021A	1	RESISTOR	4021	1	RESISTOR
4022	4022A	1	RESISTOR	4022	1	RESISTOR
4023	4023A	1	RESISTOR	4023	1	RESISTOR
4024	4024A	1	RESISTOR	4024	1	RESISTOR
4025	4025A	1	RESISTOR	4025	1	RESISTOR
4026	4026A	1	RESISTOR	4026	1	RESISTOR
4027	4027A	1	RESISTOR	4027	1	RESISTOR
4028	4028A	1	RESISTOR	4028	1	RESISTOR
4029	4029A	1	RESISTOR	4029	1	RESISTOR
4030	4030A	1	RESISTOR	4030	1	RESISTOR
4031	4031A	1	RESISTOR	4031	1	RESISTOR
4032	4032A	1	RESISTOR	4032	1	RESISTOR
4033	4033A	1	RESISTOR	4033	1	RESISTOR
4034	4034A	1	RESISTOR	4034	1	RESISTOR
4035	4035A	1	RESISTOR	4035	1	RESISTOR
4036	4036A	1	RESISTOR	4036	1	RESISTOR
4037	4037A	1	RESISTOR	4037	1	RESISTOR
4038	4038A	1	RESISTOR	4038	1	RESISTOR
4039	4039A	1	RESISTOR	4039	1	RESISTOR
4040	4040A	1	RESISTOR	4040	1	RESISTOR
4041	4041A	1	RESISTOR	4041	1	RESISTOR
4042	4042A	1	RESISTOR	4042	1	RESISTOR

Interchangeable Parts at Manufacture Stage

Part No.	Part Name	Part No.	Part Name
A1	03001-4004	03A	03001-4004
A2	03002-4008	03B	03002-4008
A3	03003-4008	03C	03003-4008
A4	03004-4008	03D	03004-4008
A5	03005-4018	03E	03005-4018
A6	03006-4018	03F	03006-4018
A7	03007-4018	03G	03007-4018

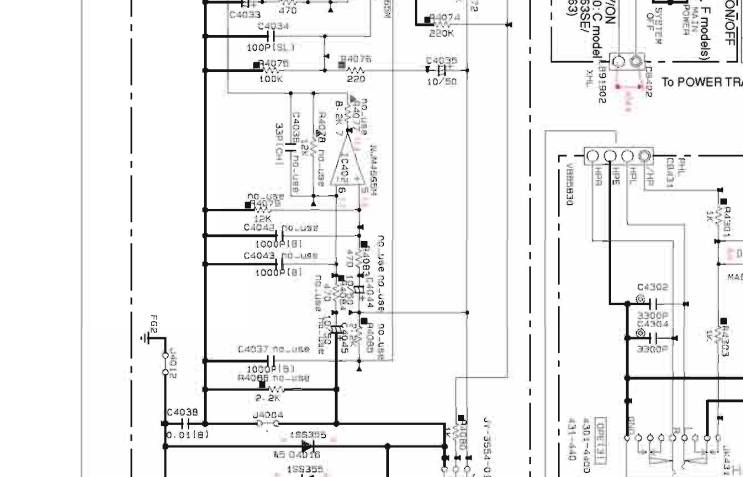
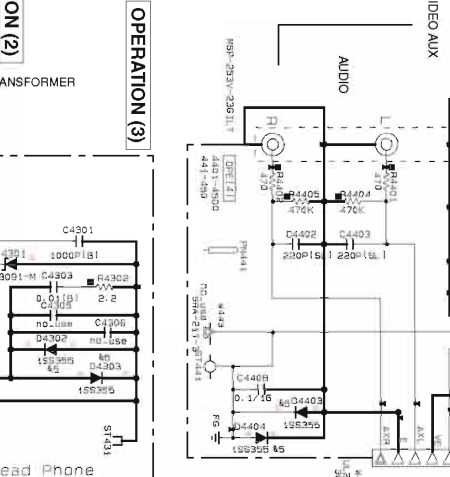
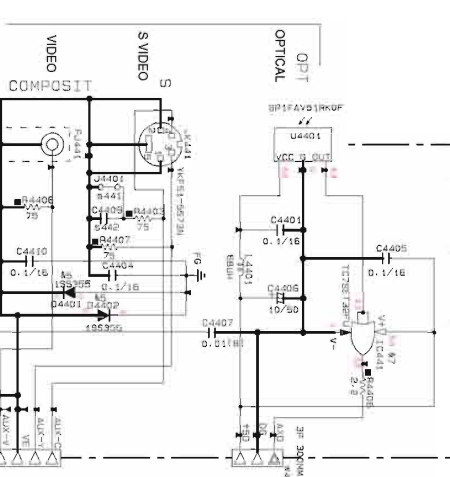
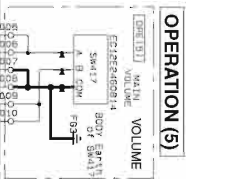
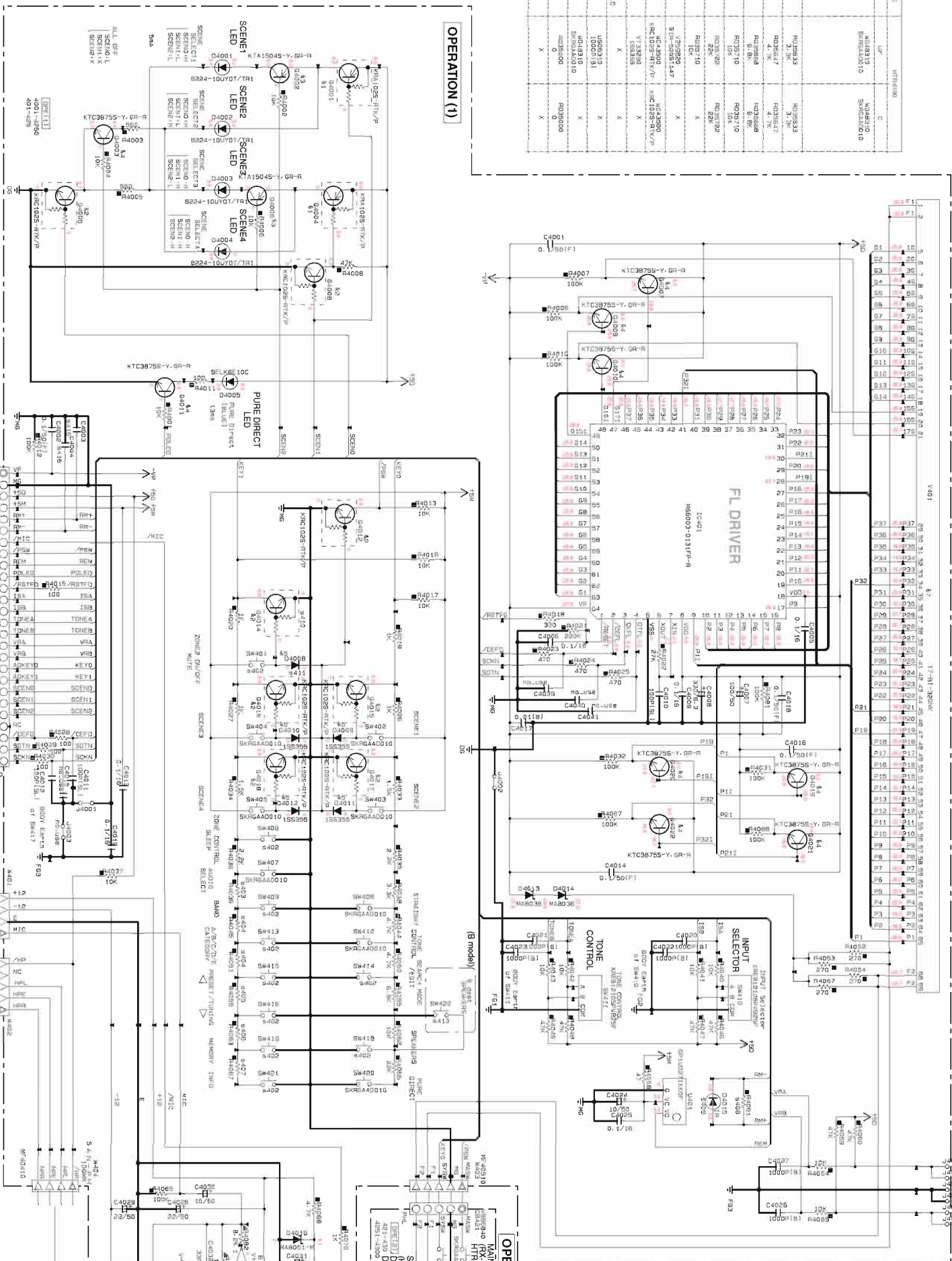

* All voltages are measured with a 10kΩV OC electronic voltmeter.
 * Components having special characteristics are marked A and must be replaced with parts having specifications equal to those originally installed.
 * Schematic diagram is subject to change without notice.

● 電圧は、内部抵抗10kΩの電圧計で測定したものです。
 ● A印のある部品は、安全性能部品を示しています。部品の交換が必要な場合、Aマークに記号されている部品を使用してください。
 ● 本回路図は機軸回路図です。改良のため予告なく変更することがあります。

Page 108 [B2] to DIGITAL_C930

Page 110 [F2] to DIGITAL_C963

Page 112 [G8] to FUNCTION (1)_CR221

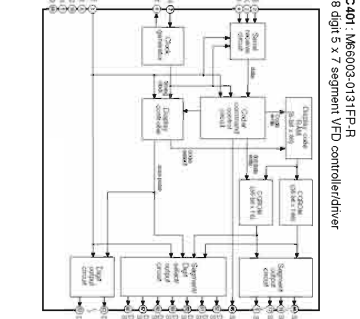
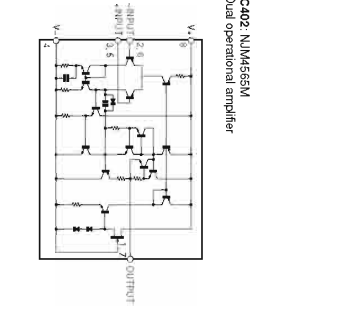
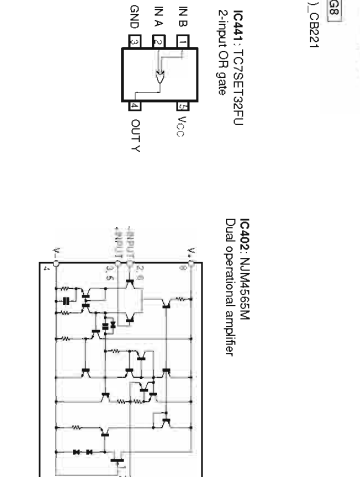

No replacement part available.
サービス部品供給なし

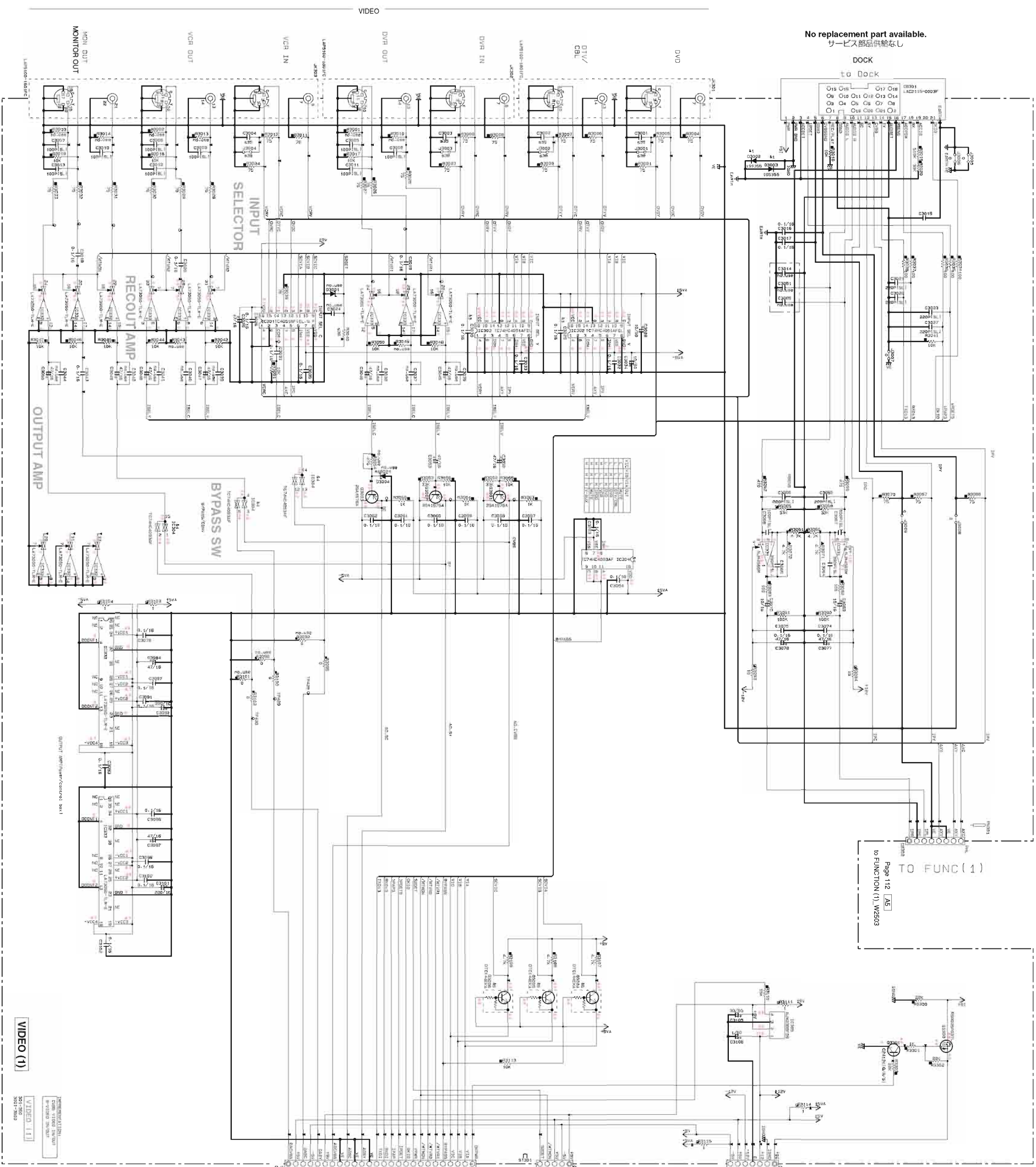

REPLACEMENT PARTS LIST

NO.	DESCRIPTION	PART NUMBER
1	RESISTOR	RESISTOR
2	CAPACITOR	CAPACITOR
3	IC	IC
4	TRANSISTOR	TRANSISTOR
5	DIODE	DIODE
6	RELAY	RELAY
7	CONNECTOR	CONNECTOR
8	SWITCH	SWITCH
9	MECHANICAL PART	MECHANICAL PART
10	OTHER	OTHER

NOTICE (continued)

(U) U.S.A.
(C) CANADA
(K) KOREA
(J) JAPAN
(E) EUROPE
(A) AUSTRALIA
(S) SOUTH AFRICA
(I) INDIA
(M) MALAYSIA
(P) PHILIPPINES
(T) THAILAND
(V) VIETNAM
(O) OCEANIA
(R) RUSSIA
(B) BRAZIL
(M) MEXICO
(C) CHINA
(I) INDIA
(S) SOUTH AFRICA
(J) JAPAN
(U) U.S.A.
(C) CANADA
(K) KOREA
(J) JAPAN
(E) EUROPE
(A) AUSTRALIA
(S) SOUTH AFRICA
(I) INDIA
(M) MALAYSIA
(P) PHILIPPINES
(T) THAILAND
(V) VIETNAM
(O) OCEANIA
(R) RUSSIA
(B) BRAZIL
(M) MEXICO
(C) CHINA

REVISIONS

NO.	DATE	DESCRIPTION
1	01/01/00	INITIAL RELEASE
2	01/01/00	REVISION 1
3	01/01/00	REVISION 2
4	01/01/00	REVISION 3
5	01/01/00	REVISION 4
6	01/01/00	REVISION 5
7	01/01/00	REVISION 6
8	01/01/00	REVISION 7
9	01/01/00	REVISION 8
10	01/01/00	REVISION 9
11	01/01/00	REVISION 10

CONTACTS

NO.	CONTACT	FUNCTION
1	1	POWER
2	2	GROUND
3	3	VIDEO
4	4	AUDIO
5	5	CONTROL
6	6	DATA
7	7	POWER
8	8	GROUND
9	9	VIDEO
10	10	AUDIO
11	11	CONTROL
12	12	DATA
13	13	POWER
14	14	GROUND
15	15	VIDEO
16	16	AUDIO
17	17	CONTROL
18	18	DATA
19	19	POWER
20	20	GROUND
21	21	VIDEO
22	22	AUDIO
23	23	CONTROL
24	24	DATA
25	25	POWER
26	26	GROUND
27	27	VIDEO
28	28	AUDIO
29	29	CONTROL
30	30	DATA

Page 115 [K]
to MAIN (2) W114

Page 111 [E]
to DIGITAL CB80

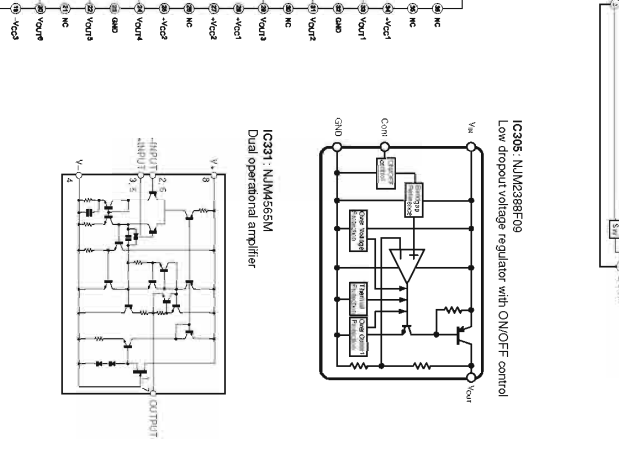
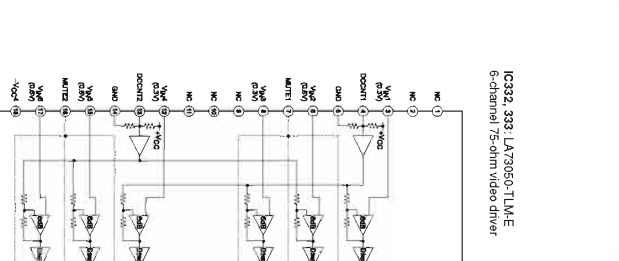
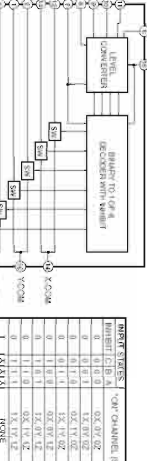
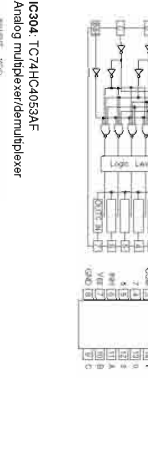
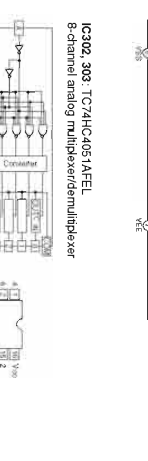
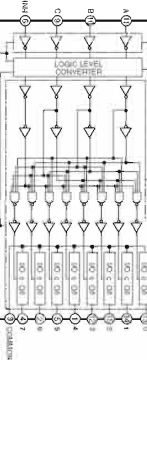

● 電圧は、内部抵抗10kΩの電圧計で測定したものです。
● 一部の部品は、安全性能部品を示しています。部品の交換が必要な場合、パーツには記載されている部品を使用してください。
● 本回路図は著作権関係です。改良のため予告なく変更することがあります。

* All voltages are measured with a 10kΩV DC electronic voltmeter.
* Components having special characteristics are marked Δ and must be replaced with parts having specifications equal to those originally installed.
* Schematic diagram is subject to change without notice.

■ REPLACEMENT PARTS LIST

• ELECTRICAL COMPONENT PARTS

WARNING

- Components having special characteristics are marked \triangle and must be replaced with parts having specifications equal to those originally installed.
- The chip resistor is not supplied as a replacement part.
 - * When a chip resistor is necessary, use the following part.
AAX60720: CHIP RESISTOR SAMPLE BOOK
- \triangle 印のある部分は、安全確保部品を示しています。部品の交換が必要な場合、パーツリストに記載されている部品を使用してください。
- 部品価格ランクは、予告なく変更することがあります。
- チップ抵抗はサービス部品として供給できません。
 - ※ チップ抵抗が必要な場合は、下記の部品をご利用ください。
AAX60720: CHIP RESISTOR SAMPLE BOOK

ABBREVIATIONS IN THIS LIST ARE AS FOLLOWS:

C.A.EL.CHP	: CHIP ALUMI.ELECTROLYTIC CAP	L.EMIT	: LIGHT EMITTING MODULE
C.CE	: CERAMIC CAP	LED.DSPLY	: LED DISPLAY
C.CE.ARRAY	: CERAMIC CAP ARRAY	LED.INFRD	: LED,INFRARED
C.CE.CHP	: CHIP CERAMIC CAP	MODUL.RF	: MODULATOR,RF
C.CE.ML	: MULTILAYER CERAMIC CAP	PHOT.CPL	: PHOTO COUPLER
C.CE.M.CHP	: CHIP MULTILAYER CERAMIC CAP	PHOT.INTR	: PHOTO INTERRUPTER
C.CE.SAFTY	: RECOGNIZED CERAMIC CAP	PHOT.RFLCT	: PHOTO REFLECTOR
C.CE.TUBLR	: CERAMIC TUBULAR CAP	PIN.TEST	: PIN,TEST POINT
C.CE.SMI	: SEMI CONDUCTIVE CERAMIC CAP	PLST.RIVET	: PLASTIC RIVET
C.EL	: ELECTROLYTIC CAP	R.ARRAY	: RESISTOR ARRAY
C.MICA	: MICA CAP	R.CAR.	: CARBON RESISTOR
C.ML.FLM	: MULTILAYER FILM CAP	R.CAR.CHP	: CHIP RESISTOR
C.MP	: METALLIZED PAPER CAP	R.CAR.FP	: FLAME PROOF CARBON RESISTOR
C.MYLAR	: MYLAR FILM CAP	R.FUS	: FUSABLE RESISTOR
C.MYLAR.ML	: MULTILAYER MYLAR FILM CAP	R.MTL.CHP	: CHIP METAL FILM RESISTOR
C.PAPER	: PAPER CAPACITOR	R.MTL.FLM	: METAL FILM RESISTOR
C.PLS	: POLYSTYRENE FILM CAP	R.MTL.OXD	: METAL OXIDE FILM RESISTOR
C.POL	: POLYESTER FILM CAP	R.MTL.PLAT	: METAL PLATE RESISTOR
C.POLY	: POLYETHYLENE FILM CAP	RSNR.CE	: CERAMIC RESONATOR
C.PP	: POLYPROPYLENE FILM CAP	RSNR.CRYS	: CRYSTAL RESONATOR
C.TNTL	: TANTALUM CAP	R.TW.CEM	: TWIN CEMENT FIXED RESISTOR
C.TNTL.CHP	: CHIP TANTALUM CAP	R.CEMENT	: CEMENT RESISTOR
C.TRIM	: TRIMMER CAP	SCR.BND.HD	: BIND HEAD B-TIGHT SCREW
CN	: CONNECTOR	SCR.BW.HD	: BW HEAD TAPPING SCREW
CN.BS.PIN	: CONNECTOR,BASE PIN	SCR.CUP	: CUP TIGHT SCREW
CN.CANNON	: CONNECTOR,CANNON	SCR.TERM	: SCREW TERMINAL
CN.DIN	: CONNECTOR,DIN	SCR.TR	: SCREW,TRANSISTOR
CN.FLAT	: CONNECTOR,FLAT CABLE	SUPRT.PCB	: SUPPORT,P.C.B.
CN.POST	: CONNECTOR,BASE POST	SURG.PRTCT	: SURGE PROTECTOR
COIL.MX.AM	: COIL,AM MIX	SW.TACT	: TACT SWITCH
COIL.AT.FM	: COIL,FM ANTENNA	SW.LEAF	: LEAF SWITCH
COIL.DT.FM	: COIL,FM DETECT	SW.LEVER	: LEVER SWITCH
COIL.MX.FM	: COIL,FM MIX	SW.MICRO	: MICRO SWITCH
COIL.OUTPT	: OUTPUT COIL	SW.PUSH	: PUSH SWITCH
DIOD.ARRAY	: DIODE ARRAY	SW.RT.ENC	: ROTARY ENCODER
DIODE.BRG	: DIODE BRIDGE	SW.RT.MTR	: ROTARY SWITCH WITH MOTOR
DIODE.CHP	: CHIP DIODE	SW.RT	: ROTARY SWITCH
DIODE.VAR	: VARACTOR DIODE	SW.SLIDE	: SLIDE SWITCH
DIOD.Z.CHP	: CHIP ZENER DIODE	TERM.SP	: SPEAKER TERMINAL
DIODE.ZENR	: ZENER DIODE	TERM.WRAP	: WRAPPING TERMINAL
DSCR.CE	: CERAMIC DISCRIMINATOR	THRMST.CHP	: CHIP THERMISTOR
FER.BEAD	: FERRITE BEADS	TR.CHP	: CHIP TRANSISTOR
FER.CORE	: FERRITE CORE	TR.DGT	: DIGITAL TRANSISTOR
FET.CHP	: CHIP FET	TR.DGT.CHP	: CHIP DIGITAL TRANSISTOR
FL.DSPLY	: FLUORESCENT DISPLAY	TRANS	: TRANSFORMER
FLTR.CE	: CERAMIC FILTER	TRANS.PULS	: PULSE TRANSFORMER
FLTR.COMB	: COMB FILTER MODULE	TRANS.PWR	: POWER TRANSFORMER ASS'Y
FLTR.LC.RF	: LC FILTER,EMI	TUNER.AM	: TUNER PACK,AM
GND.MTL	: GROUND PLATE	TUNER.FM	: TUNER PACK,FM
GND.TERM	: GROUND TERMINAL	TUNER.PK	: FRONT-ENDTUNER PACK
HOLDER.FUS	: FUSE HOLDER	VR	: ROTARY POTENTIOMETER
IC.PRTCT	: IC PROTECTOR	VR.MTR	: POTENTIOMETER WITH MOTOR
JUMPER.CN	: JUMPER CONNECTOR	VR.SW	: POTENTIOMETER WITH ROTARY SW
JUMPER.TST	: JUMPER,TEST POINT	VR.SLIDE	: SLIDE POTENTIOMETER
L.DTCT	: LIGHT DETECTING MODULE	VR.TRIM	: TRIMMER POTENTIOMETER

P.C.B. DIGITAL

Ref No.	Part No.	Description	Remarks	Markets	部 品 名	ランク	
*	WN250000	P. C. B.	DIGITAL		J	PCB DIGITAL	
*	WN250100	P. C. B.	DIGITAL	863	U	PCB DIGITAL	
*	WN252000	P. C. B.	DIGITAL	6180	U	PCB DIGITAL	
*	WN250200	P. C. B.	DIGITAL	863	C	PCB DIGITAL	
*	WN252100	P. C. B.	DIGITAL	6180	C	PCB DIGITAL	
*	WN250300	P. C. B.	DIGITAL		R	PCB DIGITAL	
*	WN250400	P. C. B.	DIGITAL		T	PCB DIGITAL	
*	WN251000	P. C. B.	DIGITAL		K	PCB DIGITAL	
*	WN251100	P. C. B.	DIGITAL		A	PCB DIGITAL	
*	WN251200	P. C. B.	DIGITAL		B	PCB DIGITAL	
*	WN251300	P. C. B.	DIGITAL	863	GEF	PCB DIGITAL	
*	WN252200	P. C. B.	DIGITAL	6180	F	PCB DIGITAL	
*	WN251400	P. C. B.	DIGITAL		L	PCB DIGITAL	
CB10-14	WM462600	CN. HDMI	19P SE			コネクタ HDMI	
CB14	WA014300	CN	7P SE FMN		J	FMNコネクター	01
CB30	VN520900	CN. BS. PIN	52045 26P TE			FFCコネクター	02
CB31	VB389600	CN. BS. PIN	11P			コネクタベースポスト	01
CB32	VB858400	CN. BS. PIN	5P			ベースピン	01
CB33	VB858500	CN. BS. PIN	6P			ベースピン	01
CB34	VP127700	CN	24P			コネクター	01
CB36	VQ044400	CN. BS. PIN	9P			FFCコネクター	01
CB38	VB389800	CN. BS. PIN	2P		J	ベースピン	01
CB39	VC014700	CN. BS. PIN	3P		U	コネクタベースポスト	01
CB41	WJ458700	CN. XM	4P, CAM-D96		UC	XMコネクター	
CB46	VB858200	CN. BS. PIN	3P			ベースピン	01
CB61	VP082900	CN. BS. PIN	25P			FFCコネクター	02
CB62	VB858800	CN. BS. PIN	9P			ベースピン	01
CB63	VB858300	CN. BS. PIN	4P			コネクタベースポスト	01
CB80	VN520900	CN. BS. PIN	52045 26P TE			FFCコネクター	02
CB81	VM859700	CN. BS. PIN	16P			FFCコネクター	01
CB82	LB919050	CN. BS. PIN	5P			ベース付ポスト	01
C100	WD758300	C. CE. CHP	10uF 10V			チップセラコン	01
C101-103	US135100	C. CE. CHP	0.1uF 16V			チップセラコン	01
C104-105	WD758300	C. CE. CHP	10uF 10V			チップセラコン	01
C106	US063100	C. CE. CHP	1000pF 50V B			チップセラコン	01
C107	WD758300	C. CE. CHP	10uF 10V			チップセラコン	01
C108-115	US135100	C. CE. CHP	0.1uF 16V			チップセラコン	01
C116	WD758300	C. CE. CHP	10uF 10V			チップセラコン	01
C117	US135100	C. CE. CHP	0.1uF 16V			チップセラコン	01
C118	WD758300	C. CE. CHP	10uF 10V			チップセラコン	01
C119	US135100	C. CE. CHP	0.1uF 16V			チップセラコン	01
C120	WD758300	C. CE. CHP	10uF 10V			チップセラコン	01
C121-122	US135100	C. CE. CHP	0.1uF 16V			チップセラコン	01
C124	US135100	C. CE. CHP	0.1uF 16V			チップセラコン	01
C125-126	US061150	C. CE. CHP	15pF 50V B			チップセラコン	01
C127-128	US135100	C. CE. CHP	0.1uF 16V			チップセラコン	01
C129	WD758300	C. CE. CHP	10uF 10V			チップセラコン	01
C130-134	US135100	C. CE. CHP	0.1uF 16V			チップセラコン	01
C135-138	US061100	C. CE. CHP	10pF 50V B			チップセラコン	01
C139-144	US135100	C. CE. CHP	0.1uF 16V			チップセラコン	01
C145	WD758300	C. CE. CHP	10uF 10V			チップセラコン	01
C146	US063100	C. CE. CHP	1000pF 50V B			チップセラコン	01
C147-149	US135100	C. CE. CHP	0.1uF 16V			チップセラコン	01
C150	US063100	C. CE. CHP	1000pF 50V B			チップセラコン	01
C151-157	US135100	C. CE. CHP	0.1uF 16V			チップセラコン	01

* New Parts * 新規部品

RX-V863/HTR-6180/
DSP-AX863SE/DSP-AX863

P.C.B. DIGITAL

Ref No.	Part No.	Description	Remarks	Markets	部 品 名	ランク	
C158	US063100	C.CE.CHP	1000pF	50V B		チップセラコン	01
C159-160	US135100	C.CE.CHP	0.1uF	16V		チップセラコン	01
C161-166	US061100	C.CE.CHP	10pF	50V B		チップセラコン	01
C167-168	US135100	C.CE.CHP	0.1uF	16V		チップセラコン	01
C169-170	US061100	C.CE.CHP	10pF	50V B		チップセラコン	01
C171	US063100	C.CE.CHP	1000pF	50V B		チップセラコン	01
C172	US061100	C.CE.CHP	10pF	50V B		チップセラコン	01
C173-175	US135100	C.CE.CHP	0.1uF	16V		チップセラコン	01
C176	WD758300	C.CE.CHP	10uF	10V		チップセラコン	01
C177-178	US135100	C.CE.CHP	0.1uF	16V		チップセラコン	01
C179-180	WD758300	C.CE.CHP	10uF	10V		チップセラコン	01
C181-182	US135100	C.CE.CHP	0.1uF	16V		チップセラコン	01
C183	WD758300	C.CE.CHP	10uF	10V		チップセラコン	01
C184-188	US135100	C.CE.CHP	0.1uF	16V		チップセラコン	01
C189	WD758300	C.CE.CHP	10uF	10V		チップセラコン	01
C190	US135100	C.CE.CHP	0.1uF	16V		チップセラコン	01
C191	US064100	C.CE.CHP	0.01uF	50V B		チップセラコン	01
C194	UR837220	C.EL	22uF	16V		ケミコン	01
C196	US135100	C.CE.CHP	0.1uF	16V		チップセラコン	01
C197-198	V5333500	C.CE.CHP	10uF	6.3V		チップセラコン	01
C199	US135100	C.CE.CHP	0.1uF	16V		チップセラコン	01
C200	UR837100	C.EL	10uF	16V		ケミコン	01
C202	UR837220	C.EL	22uF	16V		ケミコン	01
C204	US135100	C.CE.CHP	0.1uF	16V		チップセラコン	01
C206	US135100	C.CE.CHP	0.1uF	16V		チップセラコン	01
C208	UR837100	C.EL	10uF	16V		ケミコン	01
C211	UF037100	C.EL.CHP	10uF	16V	J	チップケミコン	01
C212	US064100	C.CE.CHP	0.01uF	50V B	J	チップセラコン	01
C214-215	US135100	C.CE.CHP	0.1uF	16V	J	チップセラコン	01
C216	US126100	C.CE.CHP	1uF	10V	J	チップセラコン	01
C217	US064100	C.CE.CHP	0.01uF	50V B	J	チップセラコン	01
C218	US126100	C.CE.CHP	1uF	10V	J	チップセラコン	01
C222-223	US135100	C.CE.CHP	0.1uF	16V	J	チップセラコン	01
C225-226	US135100	C.CE.CHP	0.1uF	16V	J	チップセラコン	01
C229-248	US135100	C.CE.CHP	0.1uF	16V	J	チップセラコン	01
C300	UR837330	C.EL	33uF	16V		ケミコン	01
C301	US135100	C.CE.CHP	0.1uF	16V		チップセラコン	01
C302-303	US064100	C.CE.CHP	0.01uF	50V B		チップセラコン	01
C306-311	US064100	C.CE.CHP	0.01uF	50V B		チップセラコン	01
C313	US064100	C.CE.CHP	0.01uF	50V B		チップセラコン	01
C314-315	US135100	C.CE.CHP	0.1uF	16V		チップセラコン	01
C316	US064100	C.CE.CHP	0.01uF	50V B		チップセラコン	01
C317-321	US135100	C.CE.CHP	0.1uF	16V		チップセラコン	01
C322-328	US063100	C.CE.CHP	1000pF	50V B		チップセラコン	01
C329	US062220	C.CE.CHP	220pF	50V B		チップセラコン	01
C330	US063100	C.CE.CHP	1000pF	50V B		チップセラコン	01
C331	US062220	C.CE.CHP	220pF	50V B		チップセラコン	01
C332	UR237470	C.EL	47uF	16V	JRTKABGEFL	ケミコン	01
C332	UR267100	C.EL	10uF	50V	UC	ケミコン	01
C333	UR237470	C.EL	47uF	16V		ケミコン	01
C334	US135100	C.CE.CHP	0.1uF	16V		チップセラコン	01
C335	UR218220	C.EL	220uF	6.3V		ケミコン	01
C336	WB165500	C.EL	0.33F	5.5V		ゴールドキャパシタ	04
C337	US135100	C.CE.CHP	0.1uF	16V		チップセラコン	01
C338	UR218330	C.EL	330uF	6.3V		ケミコン	01

* New Parts * 新規部品

P.C.B. DIGITAL

Ref No.	Part No.	Description	Remarks	Markets	部 品 名	ランク
C339	UR218220	C. EL	220uF 6.3V		ケミコン	
C340	US063100	C. CE. CHP	1000pF 50V B		チップセラコン	01
C341	US062220	C. CE. CHP	220pF 50V B		チップセラコン	01
C342	US063100	C. CE. CHP	1000pF 50V B		チップセラコン	01
C343	US062220	C. CE. CHP	220pF 50V B		チップセラコン	01
C344	US063100	C. CE. CHP	1000pF 50V B		チップセラコン	01
C345-347	US062100	C. CE. CHP	100pF 50V B		チップセラコン	01
C349	US046100	C. CE. CHP	1uF 25V	863	UCRTKAGEFL	01
C349	US046100	C. CE. CHP	1uF 25V	6180	UF	01
C350-355	US046100	C. CE. CHP	1uF 25V		チップセラコン	01
C356	US063100	C. CE. CHP	1000pF 50V B		チップセラコン	01
C357	US062100	C. CE. CHP	100pF 50V B		チップセラコン	01
C359-360	US064100	C. CE. CHP	0.01uF 50V B		チップセラコン	01
C361-368	US135100	C. CE. CHP	0.1uF 16V		チップセラコン	01
C369	US135100	C. CE. CHP	0.1uF 16V		チップセラコン	01
C401-402	US061220	C. CE. CHP	22pF 50V B		チップセラコン	01
C403-406	US135100	C. CE. CHP	0.1uF 16V		チップセラコン	01
C409-410	US135100	C. CE. CHP	0.1uF 16V		チップセラコン	01
C411-412	US062220	C. CE. CHP	220pF 50V B		チップセラコン	01
C413	UR067470	C. EL	47uF 50V		ケミコン	01
C416	US061100	C. CE. CHP	10pF 50V B		チップセラコン	01
C417-418	US035100	C. CE. CHP	0.1uF 16V B		チップセラコン	01
C419	US062220	C. CE. CHP	220pF 50V B		チップセラコン	01
C420	US061100	C. CE. CHP	10pF 50V B		チップセラコン	01
C421	US062220	C. CE. CHP	220pF 50V B		チップセラコン	01
C422	US063100	C. CE. CHP	1000pF 50V B		チップセラコン	01
C423	US035100	C. CE. CHP	0.1uF 16V B		チップセラコン	01
C424	US135100	C. CE. CHP	0.1uF 16V		チップセラコン	01
C425	US062220	C. CE. CHP	220pF 50V B		チップセラコン	01
C426	US135100	C. CE. CHP	0.1uF 16V		チップセラコン	01
C427	US062220	C. CE. CHP	220pF 50V B		チップセラコン	01
C428	UR238100	C. EL	100uF 16V		ケミコン	
C430	US062220	C. CE. CHP	220pF 50V B		チップセラコン	01
C431	US062220	C. CE. CHP	220pF 50V B		チップセラコン	01
C434-435	US135100	C. CE. CHP	0.1uF 16V		チップセラコン	01
C436	US035100	C. CE. CHP	0.1uF 16V B		チップセラコン	01
C437	US135100	C. CE. CHP	0.1uF 16V		チップセラコン	01
C438	WJ343900	C. CE. CHP	0.33uF 10V		チップセラコン	01
C439	UR837100	C. EL	10uF 16V		ケミコン	01
C440	US044220	C. CE. CHP	0.022uF 25V B		チップセラコン	01
C441	US135100	C. CE. CHP	0.1uF 16V		チップセラコン	01
C442-444	US135100	C. CE. CHP	0.1uF 16V		チップセラコン	01
C445	US062100	C. CE. CHP	100pF 50V B		チップセラコン	01
C446	UR067470	C. EL	47uF 50V		ケミコン	01
C447-448	US135100	C. CE. CHP	0.1uF 16V		チップセラコン	01
C449	US062100	C. CE. CHP	100pF 50V B		チップセラコン	01
C450	UR067470	C. EL	47uF 50V		ケミコン	01
C451-452	US135100	C. CE. CHP	0.1uF 16V		チップセラコン	01
C453-454	US060800	C. CE. CHP	8pF 50V B		チップセラコン	01
C455	US062100	C. CE. CHP	100pF 50V B		チップセラコン	01
C456	UU297220	C. EL	22uF 100V		ケミコン	01
C457	UR837100	C. EL	10uF 16V		ケミコン	01
C458	UU297220	C. EL	22uF 100V		ケミコン	01
C460	UR067100	C. EL	10uF 50V		ケミコン	01
C461	US126100	C. CE. CHP	1uF 10V		チップセラコン	01

* New Parts * 新規部品

RX-V863/HTR-6180/
DSP-AX863SE/DSP-AX863

P.C.B. DIGITAL

Ref No.	Part No.	Description	Remarks	Markets	部 品 名	ランク	
C462-470	US135100	C.CE.CHP	0.1uF 16V		チップセラコン	01	
C472-475	US135100	C.CE.CHP	0.1uF 16V		チップセラコン	01	
C477	US135100	C.CE.CHP	0.1uF 16V		チップセラコン	01	
C478	WG251600	C.CE.CHP	4.7uF 6.3V		チップセラコン	01	
C479-483	US135100	C.CE.CHP	0.1uF 16V		チップセラコン	01	
C484	WG251600	C.CE.CHP	4.7uF 6.3V		チップセラコン	01	
C485	UR219100	C.EL	1000uF 6.3V		ケミコン		
C486	US135100	C.CE.CHP	0.1uF 16V		チップセラコン	01	
C487	US062680	C.CE.CHP	680pF 50V B		チップセラコン	01	
C488	UR267470	C.EL	47uF 50V		ケミコン	01	
C489	WG251600	C.CE.CHP	4.7uF 6.3V		チップセラコン	01	
C490-493	US135100	C.CE.CHP	0.1uF 16V		チップセラコン	01	
C494	UR067470	C.EL	47uF 50V		ケミコン	01	
C495-502	US135100	C.CE.CHP	0.1uF 16V		チップセラコン	01	
C503	US135100	C.CE.CHP	0.1uF 16V	UC	チップセラコン	01	
C504-505	US064100	C.CE.CHP	0.01uF 50V B		チップセラコン	01	
C506	US135100	C.CE.CHP	0.1uF 16V	UC	チップセラコン	01	
C507-508	US135100	C.CE.CHP	0.1uF 16V		チップセラコン	01	
C509-510	US064100	C.CE.CHP	0.01uF 50V B		チップセラコン	01	
C516	US135100	C.CE.CHP	0.1uF 16V		チップセラコン	01	
C517	UR067470	C.EL	47uF 50V		ケミコン	01	
C518	US135100	C.CE.CHP	0.1uF 16V		チップセラコン	01	
C519	US063100	C.CE.CHP	1000pF 50V B		チップセラコン	01	
C520-521	US135100	C.CE.CHP	0.1uF 16V		チップセラコン	01	
C522-524	US063100	C.CE.CHP	1000pF 50V B		チップセラコン	01	
C525-526	US135100	C.CE.CHP	0.1uF 16V		チップセラコン	01	
C527-529	US063100	C.CE.CHP	1000pF 50V B		チップセラコン	01	
C530-532	US135100	C.CE.CHP	0.1uF 16V		チップセラコン	01	
C544-577	US135100	C.CE.CHP	0.1uF 16V		チップセラコン	01	
C579-584	US135100	C.CE.CHP	0.1uF 16V		チップセラコン	01	
C602	US064100	C.CE.CHP	0.01uF 50V B	863	UC	チップセラコン	01
C602	US064100	C.CE.CHP	0.01uF 50V B	6180	U	チップセラコン	01
C603-606	US061470	C.CE.CHP	47pF 50V B			チップセラコン	01
C607	UR237100	C.EL	10uF 16V	863	UC	ケミコン	
C607	UR237100	C.EL	10uF 16V	6180	U	ケミコン	
C608	US135100	C.CE.CHP	0.1uF 16V	863	UC	チップセラコン	01
C608	US135100	C.CE.CHP	0.1uF 16V	6180	U	チップセラコン	01
C609	UR218100	C.EL	100uF 6.3V	863	UC	ケミコン	
C609	UR218100	C.EL	100uF 6.3V	6180	U	ケミコン	
C610	UR067100	C.EL	10uF 50V			ケミコン	01
C611-612	US135100	C.CE.CHP	0.1uF 16V			チップセラコン	01
C613	UR837470	C.EL	47uF 16V	863	UC	ケミコン	01
C613	UR837470	C.EL	47uF 16V	6180	U	ケミコン	01
C614	UR837470	C.EL	47uF 16V	863	UC	ケミコン	01
C614	UR837470	C.EL	47uF 16V	6180	U	ケミコン	01
C615	US135100	C.CE.CHP	0.1uF 16V			チップセラコン	01
C616	US163100	C.CE.CHP	1000pF 50V	863	UC	チップセラコン	01
C616	US163100	C.CE.CHP	1000pF 50V	6180	U	チップセラコン	01
C617	US163100	C.CE.CHP	1000pF 50V	863	UC	チップセラコン	01
C617	US163100	C.CE.CHP	1000pF 50V	6180	U	チップセラコン	01
C618-621	US061470	C.CE.CHP	47pF 50V B			チップセラコン	01
C622	US163100	C.CE.CHP	1000pF 50V	863	UC	チップセラコン	01
C622	US163100	C.CE.CHP	1000pF 50V	6180	U	チップセラコン	01
C623	US163100	C.CE.CHP	1000pF 50V	863	UC	チップセラコン	01
C623	US163100	C.CE.CHP	1000pF 50V	6180	U	チップセラコン	01

* New Parts * 新規部品

P.C.B. DIGITAL

Ref No.	Part No.	Description	Remarks	Markets	部 品 名	ランク	
C624-627	US061470	C. CE. CHP	47pF 50V B		チップセラコン	01	
C628-630	US064100	C. CE. CHP	0.01uF 50V B		チップセラコン	01	
C632	UR067100	C. EL	10uF 50V		ケミコン	01	
C633	US135100	C. CE. CHP	0.1uF 16V		チップセラコン	01	
C634	US126100	C. CE. CHP	1uF 10V		チップセラコン	01	
C635-636	US062100	C. CE. CHP	100pF 50V B		チップセラコン	01	
C639	US135100	C. CE. CHP	0.1uF 16V	863	UC	チップセラコン	01
C639	US135100	C. CE. CHP	0.1uF 16V	6180	U	チップセラコン	01
C640	US135100	C. CE. CHP	0.1uF 16V	863	UC	チップセラコン	01
C640	US135100	C. CE. CHP	0.1uF 16V	6180	U	チップセラコン	01
C641	UR067100	C. EL	10uF 50V		ケミコン	01	
C642	US135100	C. CE. CHP	0.1uF 16V		チップセラコン	01	
C643	UR067100	C. EL	10uF 50V		ケミコン	01	
C644-645	US126100	C. CE. CHP	1uF 10V		チップセラコン	01	
C646-649	US135100	C. CE. CHP	0.1uF 16V		チップセラコン	01	
C650	UR348100	C. EL	100uF 25V		ケミコン	01	
C651	UR067100	C. EL	10uF 50V		ケミコン	01	
C652-654	US135100	C. CE. CHP	0.1uF 16V		チップセラコン	01	
C655	WK041800	C. EL	10uF 16V		ケミコン	01	
C656	US135100	C. CE. CHP	0.1uF 16V		チップセラコン	01	
C657	UR067100	C. EL	10uF 50V		ケミコン	01	
C658-659	US135100	C. CE. CHP	0.1uF 16V		チップセラコン	01	
C660-663	UR267100	C. EL	10uF 50V		ケミコン	01	
C664-665	UF037100	C. EL. CHP	10uF 16V		チップケミコン	01	
C666-667	UA654100	C. MYLAR	0.01uF 50V J		マイラーコン	01	
C668-669	UA652470	C. MYLAR	470pF 50V J		マイラーコン	01	
C670-671	US135100	C. CE. CHP	0.1uF 16V		チップセラコン	01	
C672	UA654470	C. MYLAR	0.047uF 50V J		マイラーコン	01	
C673-677	UA652680	C. MYLAR	680pF 50V J		マイラーコン	01	
C678-679	UR067100	C. EL	10uF 50V		ケミコン	01	
C680-683	UA652150	C. MYLAR	150pF 50V J		マイラーコン	01	
C684	UA652100	C. MYLAR	100pF 50V J		マイラーコン	01	
C685	UA653680	C. MYLAR	6800pF 50V J		マイラーコン	01	
C686-689	UA652100	C. MYLAR	100pF 50V J		マイラーコン	01	
C690-691	UR267100	C. EL	10uF 50V		ケミコン	01	
C692-707	US135100	C. CE. CHP	0.1uF 16V		チップセラコン	01	
C708-709	UR067470	C. EL	47uF 50V		ケミコン	01	
C710-711	UR267470	C. EL	47uF 50V		ケミコン	01	
C716-717	US135100	C. CE. CHP	0.1uF 16V		チップセラコン	01	
C800-801	UR237470	C. EL	47uF 16V		ケミコン	01	
C802-803	US135100	C. CE. CHP	0.1uF 16V		チップセラコン	01	
C804	US060800	C. CE. CHP	8pF 50V B		JUCRK	チップセラコン	01
C804	US060300	C. CE. CHP	3pF 50V B		TABGEFL	チップセラコン	01
C805	US061100	C. CE. CHP	10pF 50V B		JUCRK	チップセラコン	01
C805	US060400	C. CE. CHP	4pF 50V B		TABGEFL	チップセラコン	01
C806	US060500	C. CE. CHP	5pF 50V B		JUCRK	チップセラコン	01
C806	US060300	C. CE. CHP	3pF 50V B		TABGEFL	チップセラコン	01
C808-809	US061240	C. CE. CHP	24pF 50V B		チップセラコン	01	
C810	US135100	C. CE. CHP	0.1uF 16V		チップセラコン	01	
C812-814	US135100	C. CE. CHP	0.1uF 16V		チップセラコン	01	
C815-816	US064100	C. CE. CHP	0.01uF 50V B		チップセラコン	01	
C817	US135100	C. CE. CHP	0.1uF 16V		チップセラコン	01	
C818-819	WD758300	C. CE. CHP	10uF 10V		チップセラコン	01	
C820-821	UR837100	C. EL	10uF 16V		ケミコン	01	
C822-823	US135100	C. CE. CHP	0.1uF 16V		チップセラコン	01	

* New Parts * 新規部品

RX-V863/HTR-6180/DSP-AX863SE/DSP-AX863

P.C.B. DIGITAL

Ref No.	Part No.	Description	Remarks	Markets	部 品 名	ランク
C824-825	WD758300	C.CE.CHP	10uF 10V		チップセラコン	01
C826-827	US135100	C.CE.CHP	0.1uF 16V		チップセラコン	01
C828-829	US064100	C.CE.CHP	0.01uF 50V B		チップセラコン	01
C830-831	UR837470	C.EL	47uF 16V		ケミコン	01
C832	US062120	C.CE.CHP	120pF 50V B		チップセラコン	01
C833	US061220	C.CE.CHP	22pF 50V B		チップセラコン	01
C834-836	US135100	C.CE.CHP	0.1uF 16V		チップセラコン	01
C837	US062220	C.CE.CHP	220pF 50V B		チップセラコン	01
C838	US062560	C.CE.CHP	560pF 50V B		チップセラコン	01
C839	US034390	C.CE.CHP	0.039uF 16V B		チップセラコン	01
C840-841	US063100	C.CE.CHP	1000pF 50V B		チップセラコン	01
C842-847	US135100	C.CE.CHP	0.1uF 16V		チップセラコン	01
C848	US064100	C.CE.CHP	0.01uF 50V B		チップセラコン	01
C849	US135100	C.CE.CHP	0.1uF 16V		チップセラコン	01
C850	US064100	C.CE.CHP	0.01uF 50V B		チップセラコン	01
C851	US135100	C.CE.CHP	0.1uF 16V		チップセラコン	01
C852	VZ243400	C.CE.CHP	0.33uF 16V		チップセラコン	01
C853-854	US135100	C.CE.CHP	0.1uF 16V		チップセラコン	01
C855	UR218470	C.EL	470uF 6.3V		ケミコン	
C856	VZ281900	C.CE.CHP	0.47uF 16V K		チップセラ	01
C857	US034820	C.CE.CHP	0.082uF 16V K		チップセラコン	01
C858	US064100	C.CE.CHP	0.01uF 50V B		チップセラコン	01
C859	US135100	C.CE.CHP	0.1uF 16V		チップセラコン	01
C860	US060800	C.CE.CHP	8pF 50V B		チップセラコン	01
C862	US135100	C.CE.CHP	0.1uF 16V		チップセラコン	01
C863	US060700	C.CE.CHP	7pF 50V B		チップセラコン	01
C865-867	US135100	C.CE.CHP	0.1uF 16V		チップセラコン	01
C872-873	US135100	C.CE.CHP	0.1uF 16V		チップセラコン	01
C875-876	US135100	C.CE.CHP	0.1uF 16V		チップセラコン	01
C879	US135100	C.CE.CHP	0.1uF 16V		チップセラコン	01
C881	US135100	C.CE.CHP	0.1uF 16V		チップセラコン	01
C883	US135100	C.CE.CHP	0.1uF 16V		チップセラコン	01
C890	US062100	C.CE.CHP	100pF 50V B		チップセラコン	01
C891-894	US135100	C.CE.CHP	0.1uF 16V		チップセラコン	01
C895	US064100	C.CE.CHP	0.01uF 50V B		チップセラコン	01
C896	UR837220	C.EL	22uF 16V		ケミコン	01
C897	US064100	C.CE.CHP	0.01uF 50V B		チップセラコン	01
C898	US135100	C.CE.CHP	0.1uF 16V		チップセラコン	01
C899-900	US064100	C.CE.CHP	0.01uF 50V B		チップセラコン	01
C901	US135100	C.CE.CHP	0.1uF 16V		チップセラコン	01
C902	US064100	C.CE.CHP	0.01uF 50V B		チップセラコン	01
C903-904	US135100	C.CE.CHP	0.1uF 16V		チップセラコン	01
C905	US063100	C.CE.CHP	1000pF 50V B		チップセラコン	01
C906	UR837100	C.EL	10uF 16V		ケミコン	01
C907	US135100	C.CE.CHP	0.1uF 16V		チップセラコン	01
C908	US064100	C.CE.CHP	0.01uF 50V B		チップセラコン	01
C909	US135100	C.CE.CHP	0.1uF 16V		チップセラコン	01
C910	US064100	C.CE.CHP	0.01uF 50V B		チップセラコン	01
C911-912	US135100	C.CE.CHP	0.1uF 16V		チップセラコン	01
C913	US064100	C.CE.CHP	0.01uF 50V B		チップセラコン	01
C914-917	US135100	C.CE.CHP	0.1uF 16V		チップセラコン	01
C918-923	UR237220	C.EL	22uF 16V		ケミコン	
C924-928	US135100	C.CE.CHP	0.1uF 16V		チップセラコン	01
C929	US063100	C.CE.CHP	1000pF 50V B		チップセラコン	01
C930	UR837100	C.EL	10uF 16V		ケミコン	01

* New Parts * 新規部品

P.C.B. DIGITAL

Ref No.	Part No.	Description	Remarks	Markets	部 品 名	ランク
C931	UR837220	C. EL	22uF 16V		ケミコン	01
C933	US135100	C. CE. CHP	0.1uF 16V		チップセラコン	01
C934	V5333500	C. CE. CHP	10uF 6.3V		チップセラコン	01
C935	US135100	C. CE. CHP	0.1uF 16V		チップセラコン	01
C936	V5333500	C. CE. CHP	10uF 6.3V		チップセラコン	01
C937	UR837100	C. EL	10uF 16V		ケミコン	01
C940	US135100	C. CE. CHP	0.1uF 16V		チップセラコン	01
C942-944	US135100	C. CE. CHP	0.1uF 16V		チップセラコン	01
C946-974	US135100	C. CE. CHP	0.1uF 16V		チップセラコン	01
C976-992	US135100	C. CE. CHP	0.1uF 16V		チップセラコン	01
D108-110	WE674800	DIODE	AVRL161A1RINTB		チップバリスタ	01
D111	VV220700	DIODE. SHOT	RB501V-40		ショットキーダイオード	01
D112	VT332900	DIODE	1SS355		ダイオード	01
D113-114	WE674800	DIODE	AVRL161A1RINTB		チップバリスタ	01
D115-122	WH641900	ESD	PESD0603-140		ポリマーESD	01
D123-124	WE674800	DIODE	AVRL161A1RINTB		チップバリスタ	01
D126	WE674800	DIODE	AVRL161A1RINTB		チップバリスタ	01
D127-134	WH641900	ESD	PESD0603-140		ポリマーESD	01
D135-138	WE674800	DIODE	AVRL161A1RINTB		チップバリスタ	01
D139-146	WH641900	ESD	PESD0603-140		ポリマーESD	01
D147-149	WE674800	DIODE	AVRL161A1RINTB		チップバリスタ	01
D150	VT332900	DIODE	1SS355		ダイオード	01
D152-154	VT332900	DIODE	1SS355		ダイオード	01
D156	VT332900	DIODE	1SS355		ダイオード	01
D159	VV307700	DIODE	1N4002S		ダイオード	01
D160	V2376600	DIODE. SHOT	RB500V-40		ショットキーダイオード	01
D162	VT332900	DIODE	1SS355		ダイオード	01
D300	VT332900	DIODE	1SS355	6180	ダイオード	01
D301-305	VU992600	DIODE. ZENR	MA8051-M 5.1V		ツェナーダイオード	01
D306	V8960900	DIODE. ZENR	MA8024-(TX) 2.4V		ツェナーダイオード	01
D307	VT332900	DIODE	1SS355		ダイオード	01
D308	VT332900	DIODE	1SS355		ダイオード	01
D309-310	VT332900	DIODE	1SS355		ダイオード	01
D311	VV833200	DIODE	1SS380		ダイオード	01
D312-314	VT332900	DIODE	1SS355		ダイオード	01
D316	VT332900	DIODE	1SS355		ダイオード	01
D317-318	VV220700	DIODE. SHOT	RB501V-40		ショットキーダイオード	01
D401-403	WE674800	DIODE	AVRL161A1RINTB		チップバリスタ	01
D409	VT332900	DIODE	1SS355		ダイオード	01
D411	VT332900	DIODE	1SS355		ダイオード	01
D601	VT332900	DIODE	1SS355		ダイオード	01
D603-606	VT332900	DIODE	1SS355		ダイオード	01
D607-610	WB081800	DIODE. SHOT	SB01-05Q		ショットキーダイオード	01
D800-806	VT332900	DIODE	1SS355		ダイオード	01
D807	VU990500	DIODE. ZENR	MA8030-L 2.9V		ツェナーダイオード	01
D811	VT332900	DIODE	1SS355		ダイオード	01
D813-814	VT332900	DIODE	1SS355		ダイオード	01
D816	VT332900	DIODE	1SS355		ダイオード	01
D820	VT332900	DIODE	1SS355		ダイオード	01
F100	V2997600	SW. POLY	SMDC050-02		ポリスイッチ	01
IC11	X7741A00	IC	NJM2867F3-05(Te1)		電源IC	02
IC12	X0199B00	IC	TC74VHC157FT(EL, K)		ロジックIC	01
IC13	XZ287A00	IC	SN74LVC245APWR		ロジックIC	02
IC14	XS775A00	IC	TC7SH04FU		ロジックICフラット	01
IC19	X9460A00	IC	R1172H181B-T1-F		電源IC	01

*

* New Parts * 新規部品

P.C.B. DIGITAL

Ref No.	Part No.	Description	Remarks	Markets	部 品 名	ランク
*	IC20	X8986A00 IC	R1232D181A-TR-F		DC-DCコンバータ	
	IC21	X8194A00 IC	R1172H331D-T1-F		電源IC	03
*	IC24	X9370D00 IC.CEC	MN103SFD7GYAC	written	J IC CEC	
	IC30	X8328A00 IC.CPU	M30878FJBG	boot only	IC CPU	10
*	IC32	X9428A00 IC	R1154H058B-T1-F		電源IC	
	IC41	X7746A00 IC	LC89057W-VF4AD-E		IC	07
	IC42	X8192A00 IC	F2621E-01-TR		IC	
	IC45-46	XV894A00 IC	TC74VHC153FT MULTI		ロジックIC	03
	IC47	X7195A00 IC	R1172S121D-E2-F		電源IC	04
	IC48	X8194A00 IC	R1172H331D-T1-F		電源IC	03
*	IC49	X9625A00 IC	M12L64164A-5TG		メモリIC 64M	
	IC50	X4964B00 IC	TC74VHC541FT (EL, K)		ロジックIC	02
*	IC51	X9627A00 IC	EN29LV160AB-70TCP	written	メモリIC 16M	
	IC52	XZ509A00 IC	TC74VHC04FT INVER		ロジックIC	01
*	IC54	XZ744B00 IC	TC74VHCT541AFT		ロジックIC	
	IC55	X0199B00 IC	TC74VHC157FT (EL, K)		ロジックIC	01
	IC56	XV891B00 IC	TC74VHC08FT (EL, K)		ロジックIC	01
	IC57	X7378A00 IC	NJM4565M(Te1)		アンプIC	01
	IC61	X7375A00 IC	PCM1781DBQR	863	UC IC	04
	IC61	X7375A00 IC	PCM1781DBQR	6180	U IC	04
	IC62	X0199B00 IC	TC74VHC157FT (EL, K)		ロジックIC	01
	IC63	XS534A00 IC	NJM78M05DL1A		電源IC	02
	IC64	X7356A00 IC	PCM1780DBQR		IC	04
	IC65	X7355A00 IC	PCM1680DBQR		IC	07
	IC66	X7357A00 IC	PCM1803DBR		IC	04
	IC67	X7378A00 IC	NJM4565M(Te1)		アンプIC	01
	IC68-70	X5482A00 IC	NE5532DR OP AMP		アンプIC	
	IC71	X7378A00 IC	NJM4565M(Te1)		アンプIC	01
	IC72	X7378A00 IC	NJM4565M(Te1)	863	UC アンプIC	01
	IC72	X7378A00 IC	NJM4565M(Te1)	6180	U アンプIC	01
	IC80	X8897A00 IC	R1172S331B-E2-F		電源IC	03
*	IC81	X8986A00 IC	R1232D181A-TR-F		DC-DCコンバータ	
*	IC82	X9393A00 IC	ADV7800BSTZ-80		ICビデオデコーダ	
	IC83	X7762A00 IC	ABT1010		IC	14
	IC84	X6671A00 IC	ADV7172KSTZ		IC	09
	IC85	X7818A00 IC	LC74782JM-8A16-TLM		IC	07
	IC86-87	XZ509A00 IC	TC74VHC04FT INVER		ロジックIC	01
	IC89	X8531A00 IC	TC7WZ32FK		ロジックIC	
	IC91-93	XZ283A00 IC	SN74LVTH245APW BUS		ロジックIC	04
	JK41	VV269500 CN	8P DIN		UC 複合コネクタ	03
	PJ41	V5715300 JACK.PIN	2P OR/OR		ピンジャック	02
	Q100-104	VQ986700 TR	2SC4081 T106		トランジスタ	01
	Q105	WE834500 FET	UPA672T-T1-A		FET	01
	Q106	VQ986700 TR	2SC4081 T106		トランジスタ	01
	Q107	WE834500 FET	UPA672T-T1-A		FET	01
	Q108-109	VV655700 TR.DGT	DTC144EKA		J デジタルトランジスタ	01
	Q110-111	VV655700 TR.DGT	DTC144EKA		デジタルトランジスタ	01
	Q300	VP872600 TR	2SA1708 S, T		トランジスタ	01
	Q301	VV655700 TR.DGT	DTC144EKA		デジタルトランジスタ	01
	Q304	VV655300 TR.DGT	DTA144EKA		デジタルトランジスタ	01
	Q305	VR936300 TR	2SA1576A T106	863	UCRTKAGEFL トランジスタ	01
	Q305	VR936300 TR	2SA1576A T106	6180	UF トランジスタ	01
	Q306-311	VR936300 TR	2SA1576A T106		トランジスタ	01
	Q312	WH445000 FET	3LN01C-TB-E		U FET	01
	Q313	WH445000 FET	3LN01C-TB-E		FET	01

* New Parts * 新規部品

P.C.B. DIGITAL and P.C.B. FUNCTION

Ref No.	Part No.	Description	Remarks	Markets	部 品 名	ランク
Q401	VV655400	TR. DGT	DTC114EKA		デジタルトランジスタ	01
Q402	VD303700	TR	2SC3326 A,B		トランジスタ	01
Q403	VV655200	TR. DGT	DTA143EKA		デジタルトランジスタ	01
Q800	VR936300	TR	2SA1576A T106		トランジスタ	01
Q806	WH445000	FET	3LN01C-TB-E		F E T	01
R413	HV753100	R. CAR. FP	1Ω 1/4W	863	不燃化カーボン抵抗	
R413	HF353100	R. CAR	1Ω 1/2W	6180	カーボン抵抗	
R476	HV753100	R. CAR. FP	1Ω 1/4W		不燃化カーボン抵抗	
R509	V8070000	R. MTL. FLM	1Ω 1W		金属被膜抵抗	01
R521	V8070000	R. MTL. FLM	1Ω 1W		金属被膜抵抗	01
R609	V8070400	R. MTL. FLM	15Ω 1W		金属被膜抵抗	
R626	HV753100	R. CAR. FP	1Ω 1/4W		不燃化カーボン抵抗	01
R637-638	HV753220	R. CAR. FP	2.2Ω 1/4W		不燃化カーボン抵抗	01
R800-801	HV753100	R. CAR. FP	1Ω 1/4W		不燃化カーボン抵抗	01
R840	HV753220	R. CAR. FP	2.2Ω 1/4W		不燃化カーボン抵抗	01
R941	V8070000	R. MTL. FLM	1Ω 1W		金属被膜抵抗	
ST100	V4040500	SCR. TERM	M3		スクリュー/ターミナル	01
* U41	WN333300	CN. PHOTO. T	1P JST1165		光ファイバー送信器	
* U42-44	WN333200	CN. PHOTO. R	1P JSR1165		光ファイバー受信器	
XL10	WH625000	RSNR. CRY	27MHz		水晶振動子	03
XL12	WM227900	RSNR. CE	10MHz		セラミック振動子	03
XL30	WF997400	RSNR. CE	20MHz		セラミック振動子	02
XL41	WH455300	RSNR. CRY	45.1584MHz		水晶振動子	
XL42	V3625700	RSNR. CRY	24.576MHz		水晶振動子	03
XL80	WD280800	RSNR. CRY	14.31818MHz		水晶振動子	03
XL80	WD280900	RSNR. CRY	17.734475MHz		水晶振動子	
XL81	VZ772700	RSNR. CRY	28.63636MHz		水晶振動子	03
* WN373100	P. C. B.	FUNCTION		863	J PCB FUNCTION	
* WN373200	P. C. B.	FUNCTION		6180	U PCB FUNCTION	
* WN373300	P. C. B.	FUNCTION			C PCB FUNCTION	
* WN374100	P. C. B.	FUNCTION			C PCB FUNCTION	
* WN373400	P. C. B.	FUNCTION			R PCB FUNCTION	
* WN373500	P. C. B.	FUNCTION			T PCB FUNCTION	
* WN373600	P. C. B.	FUNCTION			K PCB FUNCTION	
* WN373700	P. C. B.	FUNCTION			A PCB FUNCTION	
* WN373800	P. C. B.	FUNCTION			B PCB FUNCTION	
* WN373900	P. C. B.	FUNCTION			GEF PCB FUNCTION	
* WN374000	P. C. B.	FUNCTION			L PCB FUNCTION	
CB201	VB858700	CN. BS. PIN	8P		ベースピン	01
CB205	VP082900	CN. BS. PIN	25P		FFCコネクタ	02
CB206	VP798200	CN. BS. PIN	24P		FFCコネクタ	01
CB221	VB858400	CN. BS. PIN	5P		ベースピン	01
CB231	VB858600	CN. BS. PIN	7P		ベースピン	01
CB232	VB858900	CN. BS. PIN	10P		ベースピン	01
CB242	VM923600	CN. BS. PIN	13P		JCRKAGEFL FFCコネクタ	01
CB243	VB389900	CN. BS. PIN	3P		ベースピン	01
* CB244	WK835300	CN. BS. PIN	16P YDW200-16		U コネクタ	
CB245	LB918030	CN. BS. PIN	3P		U ベース付ポスト	01
CB246	V7825700	CN	7P TE TUC SERIES		コネクタプラグ	
CB247	V7827400	SOCKET	7P TE TUC SERIES		コネクタソケット	
CB251	LB918040	CN. BS. PIN	4P		ベース付ポスト	01
CB252	LB918030	CN. BS. PIN	3P		ベース付ポスト	01

* New Parts * 新規部品

RX-V863/HTR-6180/
DSP-AX863SE/DSP-AX863

P.C.B. FUNCTION

Ref No.	Part No.	Description	Remarks	Markets	部 品 名	ランク	
△	CB253	VG879900 CN. BS. PIN	2P			ベースピン	01
*	CB254-255	WN103000 CLIP. FUSE	TP00351-31		UCRTABGEFL	ヒューズクリップ	
*	CB256-257	WN103000 CLIP. FUSE	TP00351-31			ヒューズクリップ	
△	CB258	VG879900 CN. BS. PIN	2P			ベースピン	01
	CB261	V9377800 CN. BS. PIN	3P		RL	ベース付ポスト	
	CB262	V9377900 CN. BS. PIN	4P		RL	ベース付ポスト	
*	CB263-264	WN103000 CLIP. FUSE	TP00351-31		R	ヒューズクリップ	
	CB296-297	V7825500 CN	5P TE TUC SERIES			コネクタープラグ	01
	C2001	UR267100 C. EL	10uF 50V			ケミコン	
	C2002	UR218220 C. EL	220uF 6.3V			ケミコン	
	C2003-2004	UR267470 C. EL	47uF 50V			ケミコン	01
	C2005	UR218220 C. EL	220uF 6.3V			ケミコン	
	C2006	UR267100 C. EL	10uF 50V			ケミコン	
	C2007-2012	UR837100 C. EL	10uF 16V			ケミコン	01
	C2013	UR837100 C. EL	10uF 16V	863	UCRTKAGEFL	ケミコン	01
	C2013	UR837100 C. EL	10uF 16V	6180	UF	ケミコン	01
	C2014	UR837100 C. EL	10uF 16V	863	UCRTKAGEFL	ケミコン	01
	C2014	UR837100 C. EL	10uF 16V	6180	UF	ケミコン	01
	C2015-2016	UR238100 C. EL	100uF 16V			ケミコン	
	C2017-2018	UR838100 C. EL	100uF 16V			ケミコン	01
	C2019-2022	UR238100 C. EL	100uF 16V			ケミコン	
	C2023	UR267100 C. EL	10uF 50V	863	UCRTKAGEFL	ケミコン	
	C2023	UR267100 C. EL	10uF 50V	6180	UF	ケミコン	
	C2024	UR267100 C. EL	10uF 50V	863	UCRTKAGEFL	ケミコン	
	C2024	UR267100 C. EL	10uF 50V	6180	UF	ケミコン	
	C2025-2026	UR267470 C. EL	47uF 50V			ケミコン	01
	C2027-2028	UR267100 C. EL	10uF 50V			ケミコン	
	C2030	WK041800 C. EL	10uF 16V		JUCBGEF	ケミコン	01
	C2030	UR237100 C. EL	10uF 16V		RTKAL	ケミコン	
	C2031	UR267100 C. EL	10uF 50V			ケミコン	
	C2032	WK041800 C. EL	10uF 16V		JUCBGEF	ケミコン	01
	C2032	UR237100 C. EL	10uF 16V		RTKAL	ケミコン	
	C2033	WK041800 C. EL	10uF 16V		JUCBGEF	ケミコン	01
	C2033	UR237100 C. EL	10uF 16V		RTKAL	ケミコン	
	C2034	UR837100 C. EL	10uF 16V		UC	ケミコン	01
	C2036	WK041800 C. EL	10uF 16V		JUCBGEF	ケミコン	01
	C2036	UR237100 C. EL	10uF 16V		RTKAL	ケミコン	
	C2037	WK041800 C. EL	10uF 16V		JUCBGEF	ケミコン	01
	C2037	UR237100 C. EL	10uF 16V		RTKAL	ケミコン	
	C2038	WK041800 C. EL	10uF 16V		JUCBGEF	ケミコン	01
	C2038	UR237100 C. EL	10uF 16V		RTKAL	ケミコン	
	C2039	WK041800 C. EL	10uF 16V		JUCBGEF	ケミコン	01
	C2039	UR237100 C. EL	10uF 16V		RTKAL	ケミコン	
	C2040	UR837100 C. EL	10uF 16V		UC	ケミコン	01
	C2041	UA653100 C. MYLAR	1000pF 50V J			マイラーコン	03
	C2042	UA652220 C. MYLAR	220pF 50V J		KABGEFL	マイラーコン	01
	C2043	UA652220 C. MYLAR	220pF 50V J			マイラーコン	01
	C2044	UA653910 C. MYLAR	9100pF 50V J			マイラーコン	01
	C2045	UA654330 C. MYLAR	0.033uF 50V J			マイラーコン	01
	C2046	UA653910 C. MYLAR	9100pF 50V J			マイラーコン	01
	C2047	UA654330 C. MYLAR	0.033uF 50V J			マイラーコン	01
	C2048	UA652220 C. MYLAR	220pF 50V J		KABGEFL	マイラーコン	01
	C2049	UA652220 C. MYLAR	220pF 50V J			マイラーコン	01
	C2050	UA653100 C. MYLAR	1000pF 50V J			マイラーコン	03
	C2051	US064100 C. CE. CHP	0.01uF 50V B			チップセラコン	01

* New Parts * 新規部品

P.C.B. FUNCTION

Ref No.	Part No.	Description	Remarks	Markets	部 品 名	ランク
C2052-2055	US062220	C. CE. CHP	220pF 50V B		チップセラコン	01
C2056-2057	US061470	C. CE. CHP	47pF 50V B		チップセラコン	01
C2058-2063	US062220	C. CE. CHP	220pF 50V B		チップセラコン	01
C2064-2065	US061470	C. CE. CHP	47pF 50V B		チップセラコン	01
C2066-2067	US062220	C. CE. CHP	220pF 50V B		チップセラコン	01
C2068-2069	US061470	C. CE. CHP	47pF 50V B		チップセラコン	01
C2071	US061470	C. CE. CHP	47pF 50V B	863	UCRTKAGEFL	01
C2071	US061470	C. CE. CHP	47pF 50V B	6180	UF	01
C2072	US061470	C. CE. CHP	47pF 50V B	863	UCRTKAGEFL	01
C2072	US061470	C. CE. CHP	47pF 50V B	6180	UF	01
C2073-2074	US062220	C. CE. CHP	220pF 50V B		チップセラコン	01
C2076-2077	US062220	C. CE. CHP	220pF 50V B		チップセラコン	01
C2079-2080	US062220	C. CE. CHP	220pF 50V B		チップセラコン	01
C2081-2082	US062470	C. CE. CHP	470pF 50V B		チップセラコン	01
C2083	US064100	C. CE. CHP	0.01uF 50V B		チップセラコン	01
C2084-2085	US062470	C. CE. CHP	470pF 50V B		チップセラコン	01
C2086	US061470	C. CE. CHP	47pF 50V B		B チップセラコン	01
C2087	US064100	C. CE. CHP	0.01uF 50V B		チップセラコン	01
C2088-2090	US062470	C. CE. CHP	470pF 50V B		チップセラコン	01
C2091	UA654330	C. MYLAR	0.033uF 50V J		マイラーコン	01
C2092	VR169000	C. MYLAR	0.33uF 50V		マイラーコン	01
C2093	UA653820	C. MYLAR	8200pF 50V J		マイラーコン	01
C2094-2095	US135100	C. CE. CHP	0.1uF 16V		チップセラコン	01
C2096	UA653820	C. MYLAR	8200pF 50V J		マイラーコン	01
C2097	UA654330	C. MYLAR	0.033uF 50V J		マイラーコン	01
C2098	VR169000	C. MYLAR	0.33uF 50V		マイラーコン	01
C2099-2100	US135100	C. CE. CHP	0.1uF 16V		チップセラコン	01
C2101	US061470	C. CE. CHP	47pF 50V B		B チップセラコン	01
C2103	US064100	C. CE. CHP	0.01uF 50V B		チップセラコン	01
C2105-2106	US135100	C. CE. CHP	0.1uF 16V		UC チップセラコン	01
C2201-2202	UR267100	C. EL	10uF 50V		ケミコン	
C2203-2204	US135100	C. CE. CHP	0.1uF 16V		チップセラコン	01
C2205-2206	UR267100	C. EL	10uF 50V		ケミコン	
C2207-2210	US062100	C. CE. CHP	100pF 50V B		チップセラコン	01
C2211-2212	UR267100	C. EL	10uF 50V		ケミコン	
C2213-2214	US061100	C. CE. CHP	10pF 50V B		チップセラコン	01
C2217-2218	UR239100	C. EL	1000uF 16V		ケミコン	
C2251-2252	UR266220	C. EL	2.2uF 50V		ケミコン	
C2253-2254	UR267100	C. EL	10uF 50V		ケミコン	
C2255	UR837100	C. EL	10uF 16V		ケミコン	01
C2256	UR267100	C. EL	10uF 50V		ケミコン	
C2257	UR837100	C. EL	10uF 16V		ケミコン	01
C2258	UR267100	C. EL	10uF 50V		ケミコン	
C2259	US062100	C. CE. CHP	100pF 50V B		チップセラコン	01
C2260-2263	UR267100	C. EL	10uF 50V		ケミコン	
C2264-2265	UR267470	C. EL	47uF 50V		ケミコン	01
C2266-2269	UR267100	C. EL	10uF 50V		ケミコン	
C2270	VR169200	C. MYLAR	0.47uF 50V		マイラーコン	01
C2301	WK041800	C. EL	10uF 16V		JUCBGEF RTKAL	01
C2301	UR237100	C. EL	10uF 16V		ケミコン	
C2302	WK041800	C. EL	10uF 16V		JUCBGEF	01
C2302	UR237100	C. EL	10uF 16V		RTKAL ケミコン	
C2303	UA652120	C. MYLAR	120pF 50V J		マイラーコン	
C2304	WE100900	C. PP	220pF 630V		P P コン	
C2305	UA652120	C. MYLAR	120pF 50V J		マイラーコン	

* New Parts * 新規部品

RX-V863/HTR-6180/DSP-AX863SE/DSP-AX863

P.C.B. FUNCTION

Ref No.	Part No.	Description	Remarks	Markets	部 品 名	ランク
C2306	WE100900	C.PP	220pF 630V		PPコン	
* C2307	WN164900	C.PP	3300pF 100V		PPコン	
C2308	UR068100	C.EL	100uF 50V		ケミコン	01
* C2309	WN164900	C.PP	3300pF 100V		PPコン	
C2310	UR068100	C.EL	100uF 50V		ケミコン	01
C2311	WE100200	C.PP	22pF 630V	JUCBGEF	PPコン	01
C2311	WG211700	C.CE	22pF 500V	RTKAL	セラコン	01
C2312	WE100200	C.PP	22pF 630V	JUCBGEF	PPコン	01
C2312	WG211700	C.CE	22pF 500V	RTKAL	セラコン	01
C2313	WK041800	C.EL	10uF 16V	JUCBGEF	ケミコン	01
C2313	UR237100	C.EL	10uF 16V	RTKAL	ケミコン	
C2314	UA652120	C.MYLAR	120pF 50V J		マイラーコン	
C2315	WE100900	C.PP	220pF 630V		PPコン	
* C2316	WE102300	C.PP	3300pF 100V		PPコン	
C2317	UR067470	C.EL	47uF 50V		ケミコン	01
C2318	WE100200	C.PP	22pF 630V	JUCBGEF	PPコン	01
C2318	WG211700	C.CE	22pF 500V	RTKAL	セラコン	01
C2319	WK041800	C.EL	10uF 16V	JUCBGEF	ケミコン	01
C2319	UR237100	C.EL	10uF 16V	RTKAL	ケミコン	
C2320	WK041800	C.EL	10uF 16V	JUCBGEF	ケミコン	01
C2320	UR237100	C.EL	10uF 16V	RTKAL	ケミコン	
C2321	UA652120	C.MYLAR	120pF 50V J		マイラーコン	
* C2322	WN164200	C.PP	220pF 100V		PPコン	
C2323	UA652120	C.MYLAR	120pF 50V J		マイラーコン	
* C2324	WN164200	C.PP	220pF 100V		PPコン	
* C2325	WN164900	C.PP	3300pF 100V		PPコン	
C2326	UR067470	C.EL	47uF 50V		ケミコン	01
* C2327	WN164900	C.PP	3300pF 100V		PPコン	
C2328	UR067470	C.EL	47uF 50V		ケミコン	01
C2329	WE100200	C.PP	22pF 630V	JUCBGEF	PPコン	01
C2329	WG211700	C.CE	22pF 500V	RTKAL	セラコン	01
C2330	WE100200	C.PP	22pF 630V	JUCBGEF	PPコン	01
C2330	WG211700	C.CE	22pF 500V	RTKAL	セラコン	01
C2331	WK041800	C.EL	10uF 16V	JUCBGEF	ケミコン	01
C2331	UR237100	C.EL	10uF 16V	RTKAL	ケミコン	
C2332	WK041800	C.EL	10uF 16V	JUCBGEF	ケミコン	01
C2332	UR237100	C.EL	10uF 16V	RTKAL	ケミコン	
C2333	UA652120	C.MYLAR	120pF 50V J		マイラーコン	
* C2334	WN164200	C.PP	220pF 100V		PPコン	
C2335	UA652120	C.MYLAR	120pF 50V J		マイラーコン	
* C2336	WN164200	C.PP	220pF 100V		PPコン	
* C2337	WN164900	C.PP	3300pF 100V		PPコン	
C2338	UR067470	C.EL	47uF 50V		ケミコン	01
* C2339	WN164900	C.PP	3300pF 100V		PPコン	
C2340	UR067470	C.EL	47uF 50V		ケミコン	01
C2341	WE100200	C.PP	22pF 630V	JUCBGEF	PPコン	01
C2341	WG211700	C.CE	22pF 500V	RTKAL	セラコン	01
C2342	WE100200	C.PP	22pF 630V	JUCBGEF	PPコン	01
C2342	WG211700	C.CE	22pF 500V	RTKAL	セラコン	01
C2343	WK041800	C.EL	10uF 16V		ケミコン	01
C2344	WE100900	C.PP	220pF 630V		PPコン	
C2401	US061270	C.CE.CHP	27pF 50V B	GEF	チップセラコン	01
C2402	UR237100	C.EL	10uF 16V	GEF	ケミコン	
C2403	US061270	C.CE.CHP	27pF 50V B	GEF	チップセラコン	01
C2404-2405	US135100	C.CE.CHP	0.1uF 16V	GEF	チップセラコン	01

* New Parts * 新規部品

P.C.B. FUNCTION

Ref No.	Part No.	Description	Remarks	Markets	部 品 名	ランク
C2406	US062560	C. CE. CHP	560pF 50V B		チップセラコン	01
C2408-2409	US062330	C. CE. CHP	330pF 50V B		チップセラコン	01
C2410	US135100	C. CE. CHP	0.1uF 16V		チップセラコン	01
C2411	UR237470	C. EL	47uF 16V		ケミコン	01
C2412-2413	UR237470	C. EL	47uF 16V		ケミコン	01
C2414-2415	US062100	C. CE. CHP	100pF 50V B		チップセラコン	01
C2416	US063100	C. CE. CHP	1000pF 50V B		チップセラコン	01
C2417	US062100	C. CE. CHP	100pF 50V B		チップセラコン	01
C2418	US064100	C. CE. CHP	0.01uF 50V B		チップセラコン	01
C2419	US062100	C. CE. CHP	100pF 50V B		チップセラコン	01
C2421-2422	UR237470	C. EL	47uF 16V		ケミコン	01
C2501	US064100	C. CE. CHP	0.01uF 50V B		チップセラコン	01
C2502-2503	UR03A100	C. EL	10000uF 16V		ケミコン	
C2504	WJ335500	C. EL	2.2uF 50V		ケミコン	
C2505	VR324900	C. MYLAR	0.1uF 100V		マイラーコン	01
C2506	WJ335500	C. EL	2.2uF 50V	JRTKABGEFL	ケミコン	
C2506	UR866100	C. EL	1uF 50V	UC	ケミコン	01
C2506	UR866100	C. EL	1uF 50V	UC	ケミコン	01
C2507	US064100	C. CE. CHP	0.01uF 50V B		チップセラコン	01
C2508	WJ361200	C. POL. MTL	0.047uF 400V	J	メタライズドポリコン	
C2508	WJ361800	C. POL. MTL	0.022uF 630V	RTKABGEFL	メタライズドポリコン	
C2509	UR866100	C. EL	1uF 50V	JRTKABGEFL	ケミコン	01
C2510	UA653470	C. MYLAR	4700pF 50V J	JRTKABGEFL	マイラーコン	01
C2511	UA653100	C. MYLAR	1000pF 50V J		マイラーコン	03
C2512	WB696300	C. POL. MTL	0.1uF 400V	J	メタライズドポリコン	
C2512	WD257600	C. PP	0.047uF 800V	RTKABGEFL	PPコン	
△ C2513	V6185300	C. CE. SAFTY	0.01uF 275V		規格認定コンデンサ	01
C2514	UU249330	C. EL	3300uF 25V	JUCTKABGEFL	ケミコン FW	04
C2514	WD047300	C. EL	3300uF 50V	R	ケミコン KMQ	
C2515	WE102900	C. PP	0.01uF 100V		PPコン	
C2525-2527	US062100	C. CE. CHP	100pF 50V B	U	チップセラコン	01
C2528-2529	US064100	C. CE. CHP	0.01uF 50V B	U	チップセラコン	01
C2534	US064100	C. CE. CHP	0.01uF 50V B		チップセラコン	01
D2001-2002	VU994300	DIODE. ZENR	MA8075-H 7.7V		ツェナーダイオード	01
D2003-2004	VV659300	DIODE. ZENR	RLZ7.5B 7.5V		ツェナーダイオード	01
D2201-2202	VT332900	DIODE	1SS355		ダイオード	01
D2301-2302	VT332900	DIODE	1SS355		ダイオード	01
D2401	VU993000	DIODE. ZENR	MA8056-M 5.6V	GEF	ツェナーダイオード	01
D2402	VU995500	DIODE. ZENR	MA8100-H 10.3V	JCRTKAGEFL	ツェナーダイオード	02
D2501	VT332900	DIODE	1SS355		ダイオード	01
D2502	WJ286700	DIODE. BRG	RS403M 4A 140V		ダイオードブリッジ	03
D2503-2505	VT332900	DIODE	1SS355		ダイオード	01
D2506	VU993800	DIODE. ZENR	MA8068-M 6.8V	JRTKABGEFL	ツェナーダイオード	01
D2507	VU995400	DIODE. ZENR	MA8100-M 10V	JRTKABGEFL	ツェナーダイオード	
D2508	VT332900	DIODE	1SS355	JRTKABGEFL	ダイオード	01
D2509	VT332900	DIODE	1SS355		ダイオード	01
D2511	VU994900	DIODE. ZENR	MA8091-L 8.8V	JRTKABGEFL	ツェナーダイオード	
△ D2512	WH471700	DIODE. BRG	DB105 1A 600V		ダイオードブリッジ	02
△ D2512	WH471700	DIODE. BRG	DB105 1A 600V	JRTKABGEFL	ダイオードブリッジ	02
D2513	VT332900	DIODE	1SS355		ダイオード	01
D2514	WH471700	DIODE. BRG	DB105 1A 600V		ダイオードブリッジ	02
D2515-2516	VT332900	DIODE	1SS355	UC	ダイオード	01
△ F2501	WG410800	FUSE	10A 125V	UC	ヒューズ	01
△ F2501	VT942900	FUSE	T2.5A 250V	RTABGEFL	ヒューズ	01
△ F2502	WG410800	FUSE	10A 125V	JUCR	ヒューズ	01

* New Parts * 新規部品

RX-V863/HTR-6180/
DSP-AX863SE/DSP-AX863

P.C.B. FUNCTION

Ref No.	Part No.	Description	Remarks	Markets	部 品 名	ランク	
△ F2502	KB000780	FUSE	T5A 250V		TKABGEFL	ヒューズ	02
△ F2601	KB000780	FUSE	T5A 250V		R	ヒューズ	02
IC201	X3505A00	IC	NJM2068MD-TE2			アンプIC	02
IC202	X8155B00	IC	R2A15218FP			IC	
IC203	X3547A00	IC	BD3841FS		UC	IC	06
IC220	XS377A00	IC	BA15218F OP AMP			アンプIC	01
IC225-227	X7378A00	IC	NJM4565M(TE1)			アンプIC	01
* IC241	X8235A00	IC	LC72725KM		GEF	IC	
△ IC251	V8100500	PHOT.CPL	TLP421 GR		JRTKABGEFL	フォトカプラ	01
△ IC252	iG001180	IC	TC4013BP FF		JRTKABGEFL	ロジックIC	05
△ IC253	V8100500	PHOT.CPL	TLP421 GR		JRTKABGEFL	フォトカプラ	01
* PJ201	WN303900	JACK.PIN	RJ-1074+09-0H54A			ピンジャック 6 P	
PJ203	V7046800	JACK.PIN	6P MSP-246V1-01NI			ピンジャック	04
PJ204-205	V7046700	JACK.PIN	4P MSP-244V1-01NI			ピンジャック	03
PJ207	V7190400	JACK.PIN	6P			ピンジャック	03
PJ208	V7046800	JACK.PIN	6P MSP-246V1-01NI	863	UCRTKAGEFL	ピンジャック	04
PJ208	V7046800	JACK.PIN	6P MSP-246V1-01NI	6180	UF	ピンジャック	04
PJ209	V7046700	JACK.PIN	4P MSP-244V1-01NI	863	JB	ピンジャック	03
PJ209	V7046700	JACK.PIN	4P MSP-244V1-01NI	6180	C	ピンジャック	03
PJ210	WG674900	JACK.PIN	4P			ピンジャック 4 P	02
PJ293	WC612700	JACK.PIN	2P		B	ピンジャック	
PJ294	V7189700	JACK.PIN	1P			ピンジャック	01
Q2001	VZ725900	TR	2SD1938F S,T	863	UCRTKAGEFL	トランジスタ	01
Q2001	VZ725900	TR	2SD1938F S,T	6180	UF	トランジスタ	01
Q2002	VZ725900	TR	2SD1938F S,T	863	UCRTKAGEFL	トランジスタ	01
Q2002	VZ725900	TR	2SD1938F S,T	6180	UF	トランジスタ	01
Q2003	VZ725900	TR	2SD1938F S,T	863	UCRTKAGEFL	トランジスタ	01
Q2003	VZ725900	TR	2SD1938F S,T	6180	UF	トランジスタ	01
Q2004	VZ725900	TR	2SD1938F S,T	863	UCRTKAGEFL	トランジスタ	01
Q2004	VZ725900	TR	2SD1938F S,T	6180	UF	トランジスタ	01
Q2005	iC181510	TR	2SC1815 Y			トランジスタ	01
Q2006	iA101510	TR	2SA1015 Y			トランジスタ	01
Q2007-2010	VZ725900	TR	2SD1938F S,T			トランジスタ	01
Q2201-2202	VD303700	TR	2SC3326 A,B			トランジスタ	01
Q2251-2264	VZ725900	TR	2SD1938F S,T			トランジスタ	01
Q2301-2304	iC224030	TR	2SC2240 GR,BL			トランジスタ	01
Q2305-2306	V3966800	TR	2SA949 O,Y			トランジスタ	02
Q2307-2308	iC224030	TR	2SC2240 GR,BL			トランジスタ	01
Q2309	V3966800	TR	2SA949 O,Y			トランジスタ	02
Q2310-2313	iC224030	TR	2SC2240 GR,BL			トランジスタ	01
Q2314-2315	V3966800	TR	2SA949 O,Y			トランジスタ	02
Q2316-2319	iC224030	TR	2SC2240 GR,BL			トランジスタ	01
Q2320-2321	V3966800	TR	2SA949 O,Y			トランジスタ	02
Q2401	iC174020	TR	2SC1740S QRS		GEF	トランジスタ	01
Q2402	iC181510	TR	2SC1815 Y		GEF	トランジスタ	01
Q2403	iC181510	TR	2SC1815 Y		JCRTKAGEFL	トランジスタ	01
Q2501	VV655700	TR.DGT	DTC144EKA			デジタルトランジスタ	01
Q2502-2503	iC181510	TR	2SC1815 Y			トランジスタ	01
△ Q2504	WC741200	FET	2SK3850		JRTKABGEFL	F E T	03
Q2507-2508	VZ725900	TR	2SD1938F S,T			トランジスタ	01
Q2509	VV655700	TR.DGT	DTC144EKA		UC	デジタルトランジスタ	01
Q2510	WC435100	TR.DGT	KRC104S-RTK		JTKABGEFL	デジタルトランジスタ	01
R2001	HV755470	R.CAR.FP	470Ω 1/4W			不燃化カーボン抵抗	01
R2019	HV755470	R.CAR.FP	470Ω 1/4W			不燃化カーボン抵抗	01
R2098-2099	HV754470	R.CAR.FP	47Ω 1/4W			不燃化カーボン抵抗	01

* New Parts * 新規部品

P.C.B. FUNCTION

Ref No.	Part No.	Description	Remarks	Markets	部 品 名	ランク
R2207-2208	HV755120	R. CAR. FP	120Ω 1/4W		不燃化カーボン抵抗	01
R2217-2218	HF355100	R. CAR	100Ω 1/2W		カーボン抵抗	
R2289-2290	HV755100	R. CAR. FP	100Ω 1/4W		不燃化カーボン抵抗	01
R2301	HF353220	R. CAR	2.2Ω 1/2W		カーボン抵抗	
R2303-2304	HF356100	R. CAR	1KΩ 1/2W		カーボン抵抗	
R2307	HF356180	R. CAR	1.8KΩ 1/2W		カーボン抵抗	
R2309	HF356180	R. CAR	1.8KΩ 1/2W		カーボン抵抗	
R2313	HF355330	R. CAR	330Ω 1/2W		カーボン抵抗	
R2314	HF356120	R. CAR	1.2KΩ 1/2W		カーボン抵抗	
R2315	HF355330	R. CAR	330Ω 1/2W		カーボン抵抗	
R2316	HF356120	R. CAR	1.2KΩ 1/2W		カーボン抵抗	
R2317-2318	HF357330	R. CAR	33KΩ 1/2W		カーボン抵抗	
R2319-2320	HV755100	R. CAR. FP	100Ω 1/4W		不燃化カーボン抵抗	01
R2324	HF356100	R. CAR	1KΩ 1/2W		カーボン抵抗	
R2326	HF356180	R. CAR	1.8KΩ 1/2W		カーボン抵抗	
R2329	HF355330	R. CAR	330Ω 1/2W		カーボン抵抗	
R2330	HF356120	R. CAR	1.2KΩ 1/2W		カーボン抵抗	
R2331	HF357330	R. CAR	33KΩ 1/2W		カーボン抵抗	
R2332	HV755100	R. CAR. FP	100Ω 1/4W		不燃化カーボン抵抗	01
R2336-2337	HF356100	R. CAR	1KΩ 1/2W		カーボン抵抗	
R2346	HF355330	R. CAR	330Ω 1/2W		カーボン抵抗	
R2347	HF356120	R. CAR	1.2KΩ 1/2W		カーボン抵抗	
R2348	HF355330	R. CAR	330Ω 1/2W		カーボン抵抗	
R2349	HF356120	R. CAR	1.2KΩ 1/2W		カーボン抵抗	
R2350-2351	HF357330	R. CAR	33KΩ 1/2W		カーボン抵抗	
R2352-2353	HV755100	R. CAR. FP	100Ω 1/4W		不燃化カーボン抵抗	01
R2358-2359	HF356100	R. CAR	1KΩ 1/2W		カーボン抵抗	
R2368	HF355330	R. CAR	330Ω 1/2W		カーボン抵抗	
R2369	HF356120	R. CAR	1.2KΩ 1/2W		カーボン抵抗	
R2370	HF355330	R. CAR	330Ω 1/2W		カーボン抵抗	
R2371	HF356120	R. CAR	1.2KΩ 1/2W		カーボン抵抗	
R2372-2373	HF357330	R. CAR	33KΩ 1/2W		カーボン抵抗	
R2374-2375	HV755100	R. CAR. FP	100Ω 1/4W		不燃化カーボン抵抗	01
R2509	V6730000	R. CAR.	2.2MΩ 1/2W	UC	放電抵抗	01
R2511	HF356220	R. CAR	2.2KΩ 1/2W	JRTKABGEFL	カーボン抵抗	
△ R2518	WJ787400	R. MTL. FLM	0.15Ω 1W		金属被膜抵抗	
△ RY251	WJ446600	RELAY	DC ALKT321 M01	JUCTKABGEFL	電源リレー TV-8	04
△ RY251	V9366900	RELAY	DLS9D1-0(M)0.25W	R	リレー 9V TV-8	05
ST251	V4040500	SCR. TERM	M3		スクリュー/ターミナル	01
ST252	V4040500	SCR. TERM	M3	K	スクリュー/ターミナル	01
△ SW261	WB493700	VOLT. SELCT	R8140246	R	電圧切替器	
△ SW261	WD073700	VOLT. SELCT	R8140254	L	電圧切替器	
△ T2501	XW605A00	TRANS. PWR		J	電源トランス	04
△ T2501	XW606A00	TRANS. PWR		UC	電源トランス	04
△ T2501	X6351A00	TRANS. PWR		R	電源トランス	
△ T2501	XW608A00	TRANS. PWR		TKABGEFL	電源トランス	
TE251	VU543100	OUTLET. AC	2P	JUC	ACアウトレット	03
TE251	V5867400	OUTLET. AC	2P	RT	ACアウトレット	03
TE251	VT915000	OUTLET. AC	1P	A	ACアウトレット	06
TE251	VU543300	OUTLET. AC	1P	B	ACアウトレット	05
TE251	VU543400	OUTLET. AC	2P	GEFL	ACアウトレット	05
TE255	WB782600	AC INLET	R-30190(26)	J	ACインレット 2P	
XL241	V2731100	RSNR. CRYST	4.332M HC-49/U	GEF	水晶振動子	

* New Parts * 新規部品

RX-V863/HTR-6180/DSP-AX863SE/DSP-AX863

P.C.B. OPERATION

Ref No.	Part No.	Description	Remarks	Markets	部 品 名	ランク	
* 3-1	WN378100	P.C.B.	OPERATION		J	PCB OPERATION	
* 3-1	WN378200	P.C.B.	OPERATION		URTKAGEFL	PCB OPERATION	
* 3-1	WN378200	P.C.B.	OPERATION	863	C	PCB OPERATION	
* 3-1	WN378400	P.C.B.	OPERATION	6180	C	PCB OPERATION	
* 3-1	WN378300	P.C.B.	OPERATION		B	PCB OPERATION	
CB401	VQ045500	CN. BS. PIN	26P			F F Cコネクター	02
CB421	VB858400	CN. BS. PIN	5P			ベースピン	01
CB422	LB919020	CN. BS. PIN	2P			ベース付ポスト	01
CB431	VB858300	CN. BS. PIN	4P			コネクタベースポスト	01
C4001-4002	US065100	C.CE.CHP	0.1uF 50V B			チップセラコン	01
C4003	US063100	C.CE.CHP	1000pF 50V B	863	UCRTKAGEFL	チップセラコン	01
C4003	US063100	C.CE.CHP	1000pF 50V B	6180	UF	チップセラコン	01
C4004	US063100	C.CE.CHP	1000pF 50V B	863	UCRTKAGEFL	チップセラコン	01
C4004	US063100	C.CE.CHP	1000pF 50V B	6180	UF	チップセラコン	01
C4005-4006	US135100	C.CE.CHP	0.1uF 16V			チップセラコン	01
C4007	UR068100	C.EL	100uF 50V			ケミコン	01
C4008	UR218330	C.EL	330uF 6.3V			ケミコン	
C4009	US135100	C.CE.CHP	0.1uF 16V			チップセラコン	01
C4010-4012	US062100	C.CE.CHP	100pF 50V B			チップセラコン	01
C4013	US135100	C.CE.CHP	0.1uF 16V			チップセラコン	01
C4014	US065100	C.CE.CHP	0.1uF 50V B			チップセラコン	01
C4016	US065100	C.CE.CHP	0.1uF 50V B			チップセラコン	01
C4017	US064100	C.CE.CHP	0.01uF 50V B			チップセラコン	01
C4018	US065100	C.CE.CHP	0.1uF 50V B			チップセラコン	01
C4019	US135100	C.CE.CHP	0.1uF 16V			チップセラコン	01
C4020-4023	US063100	C.CE.CHP	1000pF 50V B			チップセラコン	01
C4024	UR267100	C.EL	10uF 50V			ケミコン	
C4025	US135100	C.CE.CHP	0.1uF 16V			チップセラコン	01
C4026-4027	US063100	C.CE.CHP	1000pF 50V B			チップセラコン	01
C4028-4029	UR267220	C.EL	22uF 50V			ケミコン	01
C4030	UR867100	C.EL	10uF 50V			ケミコン	01
C4031	UR867220	C.EL	22uF 50V			ケミコン	01
C4032	US061330	C.CE.CHP	33pF 50V B			チップセラコン	01
C4033	UR257470	C.EL	47uF 35V			ケミコン	01
C4034	US062100	C.CE.CHP	100pF 50V B			チップセラコン	01
C4035	UR867100	C.EL	10uF 50V			ケミコン	01
C4038	US064100	C.CE.CHP	0.01uF 50V B			チップセラコン	01
C4301	US063100	C.CE.CHP	1000pF 50V B			チップセラコン	01
C4302	UA653330	C.MYLAR	3300pF 50V J			マイラーコン	01
C4303	US064100	C.CE.CHP	0.01uF 50V B			チップセラコン	01
C4304	UA653330	C.MYLAR	3300pF 50V J			マイラーコン	01
C4401	US135100	C.CE.CHP	0.1uF 16V			チップセラコン	01
C4402-4403	US062220	C.CE.CHP	220pF 50V B			チップセラコン	01
C4404-4405	US135100	C.CE.CHP	0.1uF 16V			チップセラコン	01
C4406	UR067100	C.EL	10uF 50V			ケミコン	01
C4407	US064100	C.CE.CHP	0.01uF 50V B			チップセラコン	01
C4408	US135100	C.CE.CHP	0.1uF 16V			チップセラコン	01
C4409	US135100	C.CE.CHP	0.1uF 16V		J	チップセラコン	01
C4410	US135100	C.CE.CHP	0.1uF 16V			チップセラコン	01
D4001-4004	WJ249600	LED	ORANGE			L E D	01
D4005	WG760400	LED	SELK6E10C BLUE			L E D	04
D4008	VT332900	DIODE	1SS355	863	UCRTKAGEFL	ダイオード	01
D4008	VT332900	DIODE	1SS355	6180	UF	ダイオード	01
D4009-4012	VT332900	DIODE	1SS355			ダイオード	01
D4013-4014	VU991000	DIODE. ZENR	MA8036 3.6V			ツェナーダイオード	01

* New Parts * 新規部品

P.C.B. OPERATION

Ref No.	Part No.	Description	Remarks	Markets	部 品 名	ランク	
D4015	V2598200	LED	SIR-505ST	863	UCRTKAGEFL	L E D	01
D4015	V2598200	LED	SIR-505ST	6180	UF	L E D	01
D4016-4017	VT332900	DIODE	1SS355			ダイオード	01
D4018	VU992600	DIODE. ZENR	MA8051-M 5.1V			ツェナーダイオード	01
D4301	VU995000	DIODE. ZENR	MA8091-M 9.1V			ツェナーダイオード	
D4302-4303	VT332900	DIODE	1SS355			ダイオード	01
D4401-4404	VT332900	DIODE	1SS355			ダイオード	01
IC401	X6386A00	IC	M66003-0131FP			I C	07
IC402	X7378A00	IC	NJM4565M(TE1)			アンプ I C	01
IC441	XW814A00	IC	TC7SET32FU			ロジック I C	01
JK401	WC814400	JACK. MNI	JY-3554-01-130			ミニジャック	02
JK431	V9408200	JACK. PHONE	MSJ-064-05B GR			ホーンジャック	03
JK441	V2589500	CN. DIN	1P			ミニD I Nコネクタ	02
PJ441	V7190100	JACK. PIN	3P			ピンジャック	04
Q4001	WC434800	TR. DGT	KRA102S-RTK/P			デジタルトランジスタ	01
Q4002	WC529500	TR	KTA1504S Y GR RTK			トランジスタ	
Q4003	WC529400	TR	KTC3875S Y GR RTK			トランジスタ	01
Q4004	WC434800	TR. DGT	KRA102S-RTK/P			デジタルトランジスタ	01
Q4005	WC435000	TR. DGT	KRC102S-RTK			デジタルトランジスタ	01
Q4006	WC529500	TR	KTA1504S Y GR RTK			トランジスタ	
Q4007	WC529400	TR	KTC3875S Y GR RTK			トランジスタ	01
Q4008	WC435000	TR. DGT	KRC102S-RTK			デジタルトランジスタ	01
Q4009-4011	WC529400	TR	KTC3875S Y GR RTK			トランジスタ	01
Q4012	WC435000	TR. DGT	KRC102S-RTK			デジタルトランジスタ	01
Q4014	WC435000	TR. DGT	KRC102S-RTK		JUCRTKAGEFL	デジタルトランジスタ	01
Q4015-4018	WC435000	TR. DGT	KRC102S-RTK			デジタルトランジスタ	01
Q4019-4022	WC529400	TR	KTC3875S Y GR RTK			トランジスタ	01
ST431	V4040500	SCR. TERM	M3			スクリュー/ターミナル	01
ST441	WA246200	SCR. TERM	3.5			スクリューターミナル	
SW401	WD483100	SW. TACT	SKRGAAD010		JUCRTKAGEFL	タクト SW	01
SW402-405	WD483100	SW. TACT	SKRGAAD010			タクト SW	01
SW406	WD483100	SW. TACT	SKRGAAD010		JUCRTKAGEFL	タクト SW	01
SW407-408	WD483100	SW. TACT	SKRGAAD010			タクト SW	01
SW409	WD483100	SW. TACT	SKRGAAD010		JUCRTKAGEFL	タクト SW	01
SW410-411	V9266400	SW. RT. ENC	XREB12105PVB25F			ロータリーエンコーダ	02
SW412	WD483100	SW. TACT	SKRGAAD010			タクト SW	01
SW413-416	WD483100	SW. TACT	SKRGAAD010		JUCRTKAGEFL	タクト SW	01
SW417	V9597100	SW. RT. ENC	EC12E2460802			ロータリーエンコーダ	04
SW418-419	WD483100	SW. TACT	SKRGAAD010		JUCRTKAGEFL	タクト SW	01
SW420	WD483100	SW. TACT	SKRGAAD010			タクト SW	01
SW421	WD483100	SW. TACT	SKRGAAD010		JUCRTKAGEFL	タクト SW	01
SW422	WD483100	SW. TACT	SKRGAAD010			タクト SW	01
SW423	WD483100	SW. TACT	SKRGAAD010		B	タクト SW	01
SW424	WD483100	SW. TACT	SKRGAAD010	863	UCRTKAGEFL	タクト SW	01
SW424	WD483100	SW. TACT	SKRGAAD010	6180	UF	タクト SW	01
U401	V8210200	L. DTCT	GP1UD271XK			リモコン受光ユニット	03
U4401	WH169900	CN. PHOTO. R	1P GP1FAV51RK0F			光ファイバー受信器	04
* V401	WN049000	FL. DSPLY	17-BT-32GNK			蛍光表示管	
	V6880300	SHEET				シート/ F L	
	V6007100	SPACER. FL	4.6/10/32			スペーサ F L	

* New Parts * 新規部品

RX-V863/HTR-6180/DSP-AX863SE/DSP-AX863

P.C.B. MAIN

Ref No.	Part No.	Description	Remarks	Markets	部 品 名	ランク		
*	WN371600	P.C.B.	MAIN		J	P C B M A I N		
*	WN371700	P.C.B.	MAIN		U	P C B M A I N		
*	WN371800	P.C.B.	MAIN	863	C	P C B M A I N		
*	WN372200	P.C.B.	MAIN	6180	C	P C B M A I N		
*	WN371900	P.C.B.	MAIN		RTA	P C B M A I N		
*	WN372000	P.C.B.	MAIN		KGEFL	P C B M A I N		
*	WN372100	P.C.B.	MAIN		B	P C B M A I N		
	CB100	LB932060	CN. BS. PIN	6P		ベースポスト	01	
	CB101	LB918100	CN. BS. PIN	10P		ベース付ポスト	02	
	C1000-1001	UR058220	C.EL	220uF 35V		ケミコン	01	
	C1002-1003	UR268220	C.EL	220uF 50V		ケミコン	01	
	C1007-1008	UR267330	C.EL	33uF 50V		ケミコン	01	
	C1040-1041	UR297100	C.EL	10uF 100V		ケミコン		
*	C1042	WN164300	C.PP	330pF 100V		PPコン		
	C1043	UR397100	C.EL	10uF 100V		ケミコン	03	
*	C1045	WN164300	C.PP	330pF 100V		PPコン		
	C1046	UR397100	C.EL	10uF 100V		ケミコン	03	
*	C1048	WN164300	C.PP	330pF 100V		PPコン		
	C1049	UR397100	C.EL	10uF 100V		ケミコン	03	
*	C1051	WN164300	C.PP	330pF 100V		PPコン		
	C1052	UR397100	C.EL	10uF 100V		ケミコン	03	
*	C1053-1054	WN164300	C.PP	330pF 100V		PPコン		
	C1055-1056	UR397100	C.EL	10uF 100V		ケミコン	03	
*	C1057	WN164300	C.PP	330pF 100V		PPコン		
	C1058	UR397100	C.EL	10uF 100V		ケミコン	03	
*	C1059	WN165500	C.PP	0.022uF 100V		PPコン		
	C1060	UR297100	C.EL	10uF 100V		ケミコン		
*	C1061-1066	WN165500	C.PP	0.022uF 100V		PPコン		
	C1067	UR838100	C.EL	100uF 16V		ケミコン	01	
*	C1068-1069	WN156000	C.PP	1000pF 250V		PPコン		
	C1070	UR866470	C.EL	4.7uF 50V		ケミコン	01	
	C1071	UR03A100	C.EL	10000uF 16V		ケミコン		
	C1073	UA653100	C.MYLAR	1000pF 50V J	863	UCRTKAGEFL	マイラーコン	03
	C1073	UA653100	C.MYLAR	1000pF 50V J	6180	UF	マイラーコン	03
	C1074	UR058100	C.EL	100uF 35V		ケミコン	01	
	C1075	UR049470	C.EL	4700uF 25V		ケミコン		
	C1076	UR049100	C.EL	1000uF 25V		ケミコン		
	C1077	UR03A100	C.EL	10000uF 16V		ケミコン		
	C1078	UR039470	C.EL	4700uF 16V		ケミコン	03	
	C1079	UA653100	C.MYLAR	1000pF 50V J		マイラーコン	03	
	C1080	UA654100	C.MYLAR	0.01uF 50V J		マイラーコン	01	
	C1081	UR267100	C.EL	10uF 50V		ケミコン		
*	C1082-1083	WN165500	C.PP	0.022uF 100V		PPコン		
	C1084-1085	WJ788600	C.EL	12000uF 71V		ケミコン		
	C1087-1088	VR324900	C.MYLAR	0.1uF 100V		マイラーコン	01	
	C1089	UA654100	C.MYLAR	0.01uF 50V J	863	UCRTKAGEFL	マイラーコン	01
	C1089	UA654100	C.MYLAR	0.01uF 50V J	6180	UF	マイラーコン	01
	C1090	UR048470	C.EL	470uF 25V		ケミコン		
	C1092-1093	UA654220	C.MYLAR	0.022uF 50V J		マイラーコン	01	
	C1094-1095	VR324900	C.MYLAR	0.1uF 100V		マイラーコン	01	
	C1097	UA654100	C.MYLAR	0.01uF 50V J		マイラーコン	01	
	C1098	WG601900	C.EL	10000uF 16V		ケミコン	04	
	C1099	UA654100	C.MYLAR	0.01uF 50V J		マイラーコン	01	
	C1102-1103	UA654100	C.MYLAR	0.01uF 50V J		マイラーコン	01	
	C1108	UA654150	C.MYLAR	0.015uF 50V J		マイラーコン	01	

* New Parts * 新規部品

P.C.B. MAIN

Ref No.	Part No.	Description	Remarks	Markets	部 品 名	ランク
C1110	UA654100	C. MYLAR	0.01uF 50V J		マイラーコン	01
C1111	UA654150	C. MYLAR	0.015uF 50V J		マイラーコン	01
△ C1112	VR324900	C. MYLAR	0.1uF 100V		マイラーコン	01
C1113	UA654100	C. MYLAR	0.01uF 50V J		マイラーコン	01
C1114	UA654150	C. MYLAR	0.015uF 50V J		マイラーコン	01
C1115-1116	UA653470	C. MYLAR	4700pF 50V J		マイラーコン	01
C1117-1118	UA654100	C. MYLAR	0.01uF 50V J		マイラーコン	01
C1119	UA654150	C. MYLAR	0.015uF 50V J		マイラーコン	01
C1120	UR266100	C. EL	1uF 50V	UC	ケミコン	01
C1121	UR237470	C. EL	47uF 16V	UC	ケミコン	01
C1122-1123	UR266100	C. EL	1uF 50V		ケミコン	01
C1124	UA654470	C. MYLAR	0.047uF 50V J		マイラーコン	01
C1126-1127	UR266100	C. EL	1uF 50V		ケミコン	01
C1129-1130	UR266100	C. EL	1uF 50V		ケミコン	01
C1131	WN896900	C. EL	1uF 100V	J	ケミコン	
C1131	UU296100	C. EL	1uF 100V	UCRTKABGEFL	ケミコン	01
C1132	WN896800	C. EL	33uF 50V	J	ケミコン	
C1132	UR267330	C. EL	33uF 50V	UCRTKABGEFL	ケミコン	01
C1136	WN951300	C. EL	10uF 16V	J	ケミコン	
C1136	WK041800	C. EL	10uF 16V	UCRTKABGEFL	ケミコン	01
C1137	WN951300	C. EL	10uF 16V	J	ケミコン	
C1137	WK041800	C. EL	10uF 16V	UCRTKABGEFL	ケミコン	01
C1138	WN896800	C. EL	33uF 50V	J	ケミコン	
C1138	UR267330	C. EL	33uF 50V	UCRTKABGEFL	ケミコン	01
C1141	WN896900	C. EL	1uF 100V	J	ケミコン	
C1141	UU296100	C. EL	1uF 100V	UCRTKABGEFL	ケミコン	01
C1144	UR266100	C. EL	1uF 50V		ケミコン	01
C1147	WN951300	C. EL	10uF 16V	J	ケミコン	
C1147	WK041800	C. EL	10uF 16V	UCRTKABGEFL	ケミコン	01
C1153	UA654150	C. MYLAR	0.015uF 50V J		マイラーコン	01
C1154	UA654100	C. MYLAR	0.01uF 50V J		マイラーコン	01
C1155	UR297100	C. EL	10uF 100V		ケミコン	
C1156	UR266100	C. EL	1uF 50V		ケミコン	01
D1000	VG440500	DIODE. ZENR	MTZJ13B 13V		ツェナーダイオード	01
D1001-1002	VV307700	DIODE	1N4002S		ダイオード	01
D1003-1016	VD631600	DIODE	1SS133, 176		ダイオード	01
D1017-1018	VG435500	DIODE. ZENR	MTZJ2. 4B 2. 4V		ツェナーダイオード	01
D1019-1030	VN008700	DIODE	1SS270A		ダイオード	01
D1031	VD631600	DIODE	1SS133, 176	863	UCRTKAGEFL	ダイオード
D1031	VD631600	DIODE	1SS133, 176	6180	UF	ダイオード
D1032	VG443200	DIODE. ZENR	MTZJ30A 30V		ツェナーダイオード	01
D1033	VD631600	DIODE	1SS133, 176	863	UCRTKAGEFL	ダイオード
D1033	VD631600	DIODE	1SS133, 176	6180	UF	ダイオード
D1034	VD631600	DIODE	1SS133, 176	863	UCRTKAGEFL	ダイオード
D1034	VD631600	DIODE	1SS133, 176	6180	UF	ダイオード
△ D1035	WB121700	DIODE. BRG	RS103 1.0A 200V		ダイオードブリッジ	01
△ D1036	WJ286700	DIODE. BRG	RS403M 4A 140V		ダイオードブリッジ	03
D1037-1039	VD631600	DIODE	1SS133, 176		ダイオード	01
△ D1040	WK611100	DIODE. BRG	D6SBN20 6A 200V		ダイオードブリッジ	
D1043	VD631600	DIODE	1SS133, 176		ダイオード	01
D1044-1045	VV307700	DIODE	1N4002S		ダイオード	01
D1047	VD631600	DIODE	1SS133, 176		ダイオード	01
△ D1048	WH487300	DIODE. BRG	RS203M 2.0A 200V		ダイオードブリッジ	02
D1049	VD631600	DIODE	1SS133, 176		ダイオード	01
D1050	VG440800	DIODE. ZENR	MTZJ15B 15V		ツェナーダイオード	01

* New Parts * 新規部品

RX-V863/HTR-6180/
DSP-AX863SE/DSP-AX863

P.C.B. MAIN

Ref No.	Part No.	Description	Remarks	Markets	部 品 名	ランク
D1051	VU647200	DIODE. SHOT	RB441Q-40 T-77		ショットキーダイオード	01
D1052	VU647200	DIODE. SHOT	RB441Q-40 T-77		ショットキーダイオード	01
D1053-1058	VG437500	DIODE. ZENR	MTZJ5.1C 5.1V		ツェナーダイオード	01
D1061	VG437500	DIODE. ZENR	MTZJ5.1C 5.1V		ツェナーダイオード	01
D1062-1063	VD631600	DIODE	1SS133,176		ダイオード	01
D1064	VN008700	DIODE	1SS270A		ダイオード	01
D1065	VD631600	DIODE	1SS133,176		ダイオード	01
D1066	VN008700	DIODE	1SS270A		ダイオード	01
D1067-1069	VD631600	DIODE	1SS133,176		ダイオード	01
D1070	VG438000	DIODE. ZENR	MTZJ6.2B 6.2V		ツェナーダイオード	01
G100	V5995800	PLATE. GND			アースプレート	
IC100	X6143A00	IC	NJM2388F05 5.0V		電源IC	04
IC101	X0515A00	IC	LM61C1Z THERMAL		電源IC	03
IC102	X6143A00	IC	NJM2388F05 5.0V		電源IC	04
IC104	XJ608A00	IC	NJM7812FA		IC	02
IC105	X4154A00	IC	K1A7912PI		電源IC	
IC106	X6143A00	IC	NJM2388F05 5.0V		電源IC	04
IC107	X4419A00	IC	NJM2396F33 3.3V		電源IC	03
IC110	XJ607A00	IC	NJM7805FA 5V		IC	02
JK100	V9435700	JACK. MNI	MSJ-035-12APC	863	UCRTKAGEFL	モノラル ミニジャック
JK100	V9435700	JACK. MNI	MSJ-035-12APC	6180	UF	モノラル ミニジャック
JK102	V9435700	JACK. MNI	MSJ-035-12APC	863	UCRTKAGEFL	モノラル ミニジャック
JK102	V9435700	JACK. MNI	MSJ-035-12APC	6180	UF	モノラル ミニジャック
JK201	V9435700	JACK. MNI	MSJ-035-12APC			モノラル ミニジャック
△ Q1000	VP872600	TR	2SA1708 S, T			トランジスタ
Q1001-1006	WC529200	TR. DGT	KRC102M-AT			デジタルトランジスタ
Q1007-1013	WC398500	TR. DGT	KRA102M-AT			デジタルトランジスタ
Q1014-1015	WC529200	TR. DGT	KRC102M-AT			デジタルトランジスタ
Q1016	WC397700	TR	2N5401C-AT			トランジスタ
△ Q1019-1024	VK432900	TR	2SD1915F S, T			トランジスタ
Q1025-1030	VR325600	TR	2SC2229 O, Y			トランジスタ
Q1031	WC398400	TR	2N5551C-AT			トランジスタ
Q1032	WC397700	TR	2N5401C-AT			トランジスタ
△ Q1033	V4096100	TR	2SC4614 S, T			トランジスタ
△ Q1034	V4096000	TR	2SA1770 S, T			トランジスタ
△ Q1035	V4096100	TR	2SC4614 S, T			トランジスタ
△ Q1036	V4096000	TR	2SA1770 S, T			トランジスタ
△ Q1037	V4096100	TR	2SC4614 S, T			トランジスタ
△ Q1038	V4096000	TR	2SA1770 S, T			トランジスタ
△ Q1039	V4096100	TR	2SC4614 S, T			トランジスタ
△ Q1040	V4096000	TR	2SA1770 S, T			トランジスタ
△ Q1041	V4096100	TR	2SC4614 S, T			トランジスタ
△ Q1042	V4096000	TR	2SA1770 S, T			トランジスタ
△ Q1043	V4096100	TR	2SC4614 S, T			トランジスタ
△ Q1044	V4096000	TR	2SA1770 S, T			トランジスタ
△ Q1045-1046	WG538600	TR	KTA1046-Y-U/P			トランジスタ
Q1047	WC398400	TR	2N5551C-AT			トランジスタ
△ Q1048-1053	VR355900	TR. PAIR	A1695/C4468 OPY	IX630850, IX630860		ペアトランジスタ
Q1060-1065	WC398400	TR	2N5551C-AT			トランジスタ
Q1066	WC397700	TR	2N5401C-AT			トランジスタ
Q1067	iC181510	TR	2SC1815 Y			トランジスタ
△ Q1068	WC397700	TR	2N5401C-AT			トランジスタ
Q1069	VP872600	TR	2SA1708 S, T	863	UCRTKAGEFL	トランジスタ
Q1069	VP872600	TR	2SA1708 S, T	6180	UF	トランジスタ
Q1070	WC529200	TR. DGT	KRC102M-AT	863	UCRTKAGEFL	デジタルトランジスタ

* New Parts * 新規部品

P.C.B. MAIN

Ref No.	Part No.	Description	Remarks	Markets	部 品 名	ランク	
Q1070	WC529200	TR. DGT	KRC102M-AT	6180	UF	デジタルトランジスタ	01
△ Q1077	VK432900	TR	2SD1915F S,T			トランジスタ	01
Q1078	VR325600	TR	2SC2229 O,Y			トランジスタ	01
△ Q1079	V4096100	TR	2SC4614 S,T			トランジスタ	02
△ Q1080	V4096000	TR	2SA1770 S,T			トランジスタ	03
△ Q1081	VR355900	TR. PAIR	A1695/C4468 OPY	IX630850, IX630860		ペアトランジスタ	07
Q1083	WC398400	TR	2N5551C-AT			トランジスタ	01
Q1100	WG538600	TR	KTA1046-Y-U/P			トランジスタ	02
Q1101	iA101510	TR	2SA1015 Y			トランジスタ	01
Q1102	iC181510	TR	2SC1815 Y			トランジスタ	01
Q1103	iA101510	TR	2SA1015 Y			トランジスタ	01
Q1104	WF691400	TR	2SD2014			トランジスタ	03
Q1105	iE102620	FET	2SK246 Y			F E T	01
R1002-1003	WG728000	R. MTL. FLM	4.7KΩ 1/4W			金属被膜抵抗	01
△ R1012	HV753100	R. CAR. FP	1Ω 1/4W			不燃化カーボン抵抗	01
R1019	HV756100	R. CAR. FP	1KΩ 1/4W			不燃化カーボン抵抗	01
R1063	HF355470	R. CAR	470Ω 1/2W			カーボン抵抗	
R1065-1069	HF355470	R. CAR	470Ω 1/2W			カーボン抵抗	
R1084	WG727400	R. MTL. FLM	2.7KΩ 1/4W			金属被膜抵抗	01
R1085	WG725600	R. MTL. FLM	470Ω 1/4W			金属被膜抵抗	01
R1086	WG726200	R. MTL. FLM	820Ω 1/4W			金属被膜抵抗	01
R1087	WG727400	R. MTL. FLM	2.7KΩ 1/4W			金属被膜抵抗	01
R1088	WG725600	R. MTL. FLM	470Ω 1/4W			金属被膜抵抗	01
R1089	WG726200	R. MTL. FLM	820Ω 1/4W			金属被膜抵抗	01
R1090	WG727400	R. MTL. FLM	2.7KΩ 1/4W			金属被膜抵抗	01
R1091	WG725600	R. MTL. FLM	470Ω 1/4W			金属被膜抵抗	01
R1092	WG726200	R. MTL. FLM	820Ω 1/4W			金属被膜抵抗	01
R1093	WG727400	R. MTL. FLM	2.7KΩ 1/4W			金属被膜抵抗	01
R1094	WG725600	R. MTL. FLM	470Ω 1/4W			金属被膜抵抗	01
R1095	WG726200	R. MTL. FLM	820Ω 1/4W			金属被膜抵抗	01
R1096	WG727400	R. MTL. FLM	2.7KΩ 1/4W			金属被膜抵抗	01
R1097	WG725600	R. MTL. FLM	470Ω 1/4W			金属被膜抵抗	01
R1098	WG726200	R. MTL. FLM	820Ω 1/4W			金属被膜抵抗	01
R1099	WG727400	R. MTL. FLM	2.7KΩ 1/4W			金属被膜抵抗	01
R1100	WG725600	R. MTL. FLM	470Ω 1/4W			金属被膜抵抗	01
R1101	WG726200	R. MTL. FLM	820Ω 1/4W			金属被膜抵抗	01
* R1104	WG726400	R. MTL. FLM	1KΩ 1/4W			金属被膜抵抗	
R1105	HV755120	R. CAR. FP	120Ω 1/4W			不燃化カーボン抵抗	01
* R1106	WG726400	R. MTL. FLM	1KΩ 1/4W			金属被膜抵抗	
R1107	HV755120	R. CAR. FP	120Ω 1/4W			不燃化カーボン抵抗	01
* R1108	WG726400	R. MTL. FLM	1KΩ 1/4W			金属被膜抵抗	
R1109	HV755120	R. CAR. FP	120Ω 1/4W			不燃化カーボン抵抗	01
* R1110	WG726400	R. MTL. FLM	1KΩ 1/4W			金属被膜抵抗	
R1111	HV755120	R. CAR. FP	120Ω 1/4W			不燃化カーボン抵抗	01
* R1112	WG726400	R. MTL. FLM	1KΩ 1/4W			金属被膜抵抗	
R1113	HV755120	R. CAR. FP	120Ω 1/4W			不燃化カーボン抵抗	01
* R1114	WG726400	R. MTL. FLM	1KΩ 1/4W			金属被膜抵抗	
R1115	HV755120	R. CAR. FP	120Ω 1/4W			不燃化カーボン抵抗	01
R1116	V8072100	R. MTL. OXD	5.6KΩ 1W			酸化金属被膜抵抗	
R1117	HV755560	R. CAR. FP	560Ω 1/4W			不燃化カーボン抵抗	01
△ R1119-1130	HV755120	R. CAR. FP	120Ω 1/4W			不燃化カーボン抵抗	01
R1132	V8072000	R. MTL. OXD	4.7KΩ 1W			酸化金属被膜抵抗	
△ R1133-1145	HV754100	R. CAR. FP	10Ω 1/4W			不燃化カーボン抵抗	01
R1147-1148	HV754100	R. CAR. FP	10Ω 1/4W			不燃化カーボン抵抗	01
R1149-1150	WG471300	R. WW	0.22Ωx2 5W	RF-5EGKR22		セメント抵抗	

* New Parts * 新規部品

RX-V863/HTR-6180/
DSP-AX863SE/DSP-AX863

P.C.B. MAIN and P.C.B. VIDEO

Ref No.	Part No.	Description	Remarks	Markets	部 品 名	ランク
*	R1151	WM216400 R.WW	0.22Ω 3W		セメント抵抗	
	R1152	WG471300 R.WW	0.22Ωx2 5W	RF-5EGKR22	セメント抵抗	
*	R1153	WM216400 R.WW	0.22Ω 3W		セメント抵抗	
	R1154	WG471300 R.WW	0.22Ωx2 5W	RF-5EGKR22	セメント抵抗	
△	R1173-1178	V8070300 R.MTL.FLM	10Ω 1W		金属被膜抵抗	
△	R1202-1203	V8070200 R.MTL.FLM	4.7Ω 1W		金属被膜抵抗	
△	R1214	HV754100 R.CAR.FP	10Ω 1/4W		不燃化カーボン抵抗	01
△	R1215	HV756150 R.CAR.FP	1.5KΩ 1/4W		不燃化カーボン抵抗	01
	R1232	HV753470 R.CAR.FP	4.7Ω 1/4W		不燃化カーボン抵抗	01
	R1238	HV753470 R.CAR.FP	4.7Ω 1/4W		不燃化カーボン抵抗	01
	R1245	WG727400 R.MTL.FLM	2.7KΩ 1/4W		金属被膜抵抗	01
	R1249	WG725600 R.MTL.FLM	470Ω 1/4W		金属被膜抵抗	01
*	R1252	WG726400 R.MTL.FLM	1KΩ 1/4W		金属被膜抵抗	
	R1254	WG726200 R.MTL.FLM	820Ω 1/4W		金属被膜抵抗	01
	R1294	HF355470 R.CAR	470Ω 1/2W		カーボン抵抗	
△	R1296-1298	HV755120 R.CAR.FP	120Ω 1/4W		不燃化カーボン抵抗	01
	R1301-1302	HV754100 R.CAR.FP	10Ω 1/4W		不燃化カーボン抵抗	01
△	R1303	WG471300 R.WW	0.22Ωx2 5W	RF-5EGKR22	セメント抵抗	
△	R1307	V8070300 R.MTL.FLM	10Ω 1W		金属被膜抵抗	
	R1311	HL002220 R.MTL.OXD	0.22Ω 1/2W		酸化金属被膜抵抗	01
	R1319-1320	V8072400 R.MTL.OXD	15KΩ 1W		酸化金属被膜抵抗	
	RY100-104	WJ122400 RELAY	981-2A-24DS-SP7		リレー 24V	04
	RY105	WE648700 RELAY	DC DH24D2-0-0		リレー 24V	06
	RY106	WJ122400 RELAY	981-2A-24DS-SP7		リレー 24V	04
	ST100	V4040500 SCR.TERM	M3		スクリュー/ターミナル	01
	TE100	WH963400 TERM.SP	8P LTS0810-0020FM	JUCRTA	スピーカーターミナル	07
	TE100	WH963500 TERM.SP	8P LTS0810-0021FM	KBGEFL	スピーカーターミナル	
	TE101	WH963200 TERM.SP	6P LTS0610-0014FM	JUCRTA	スピーカーターミナル	07
	TE101	WH963300 TERM.SP	6P LTS0610-0015FM	KBGEFL	スピーカーターミナル	
	TE102	WH963000 TERM.SP	4P LTS0410-0015FM	JUCRTA	スピーカーターミナル	05
	TE102	WH963100 TERM.SP	4P LTS0410-0016FM	KBGEFL	スピーカーターミナル	
		WE774200 SCR.BND.HD	3x10 MFZN2W3		バインドBタイトネジ	01
*		WN374400 P.C.B.	VIDEO	J	PCB VIDEO	
*		WN374500 P.C.B.	VIDEO	UCRTKABGEF	PCB VIDEO	
	CB302	VB858700 CN.BS.PIN	8P		ベースピン	01
	CB303	VB858600 CN.BS.PIN	7P		ベースピン	01
	CB304	V7827200 SOCKET	5P TE TUC SERIES		コネクタソケット	
	CB305	VQ045500 CN.BS.PIN	26P		FFCコネクタ	02
	CB351-354	WD398400 CN.DIN	14P YKF45-3011	J	DINコネクタ	05
	CB355	V7827200 SOCKET	5P TE TUC SERIES		コネクタソケット	
	CB356	VQ044700 CN.BS.PIN	16P		FFCコネクタ	01
	C3001-3004	US135100 C.CE.CHP	0.1uF 16V	J	チップセラコン	01
	C3005-3013	US062100 C.CE.CHP	100pF 50V B		チップセラコン	01
	C3015-3020	US135100 C.CE.CHP	0.1uF 16V		チップセラコン	01
	C3021-3023	US062220 C.CE.CHP	220pF 50V B		チップセラコン	01
	C3025	UR237470 C.EL	47uF 16V		ケミコン	01
	C3026	US135100 C.CE.CHP	0.1uF 16V		チップセラコン	01
	C3027	US062220 C.CE.CHP	220pF 50V B		チップセラコン	01
	C3028	UR267100 C.EL	10uF 50V		ケミコン	
	C3029-3033	US135100 C.CE.CHP	0.1uF 16V		チップセラコン	01
	C3034	UR267100 C.EL	10uF 50V		ケミコン	
	C3035	US135100 C.CE.CHP	0.1uF 16V		チップセラコン	01

* New Parts * 新規部品

P.C.B. VIDEO

Ref No.	Part No.	Description	Remarks	Markets	部 品 名	ランク
C3043	US135100	C. CE. CHP	0.1uF 16V		チップセラコン	01
C3045-3050	UR837470	C. EL	47uF 16V		ケミコン	01
C3052-3053	UR837470	C. EL	47uF 16V		ケミコン	01
C3054	US135100	C. CE. CHP	0.1uF 16V		チップセラコン	01
C3055-3056	US062220	C. CE. CHP	220pF 50V B		チップセラコン	01
C3057-3063	US135100	C. CE. CHP	0.1uF 16V		チップセラコン	01
C3064-3065	US062390	C. CE. CHP	390pF 50V B		チップセラコン	01
C3067-3068	US062100	C. CE. CHP	100pF 50V B		チップセラコン	01
C3069-3070	UR837100	C. EL	10uF 16V		ケミコン	01
C3074-3076	US135100	C. CE. CHP	0.1uF 16V		チップセラコン	01
C3077-3078	UR237470	C. EL	47uF 16V		ケミコン	01
C3084	UR237470	C. EL	47uF 16V		ケミコン	01
C3087	US135100	C. CE. CHP	0.1uF 16V		チップセラコン	01
C3091	US135100	C. CE. CHP	0.1uF 16V		チップセラコン	01
C3092	UR238220	C. EL	220uF 16V		ケミコン	01
C3093	US135100	C. CE. CHP	0.1uF 16V		チップセラコン	01
C3096	US135100	C. CE. CHP	0.1uF 16V		チップセラコン	01
C3097	UR237470	C. EL	47uF 16V		ケミコン	01
C3098	US135100	C. CE. CHP	0.1uF 16V		チップセラコン	01
C3100	US135100	C. CE. CHP	0.1uF 16V		チップセラコン	01
C3101	UR238220	C. EL	220uF 16V		ケミコン	01
C3102	US135100	C. CE. CHP	0.1uF 16V		チップセラコン	01
C3105	UR267330	C. EL	33uF 50V		ケミコン	01
C3106	UR266100	C. EL	1uF 50V		ケミコン	01
C3501-3503	US060800	C. CE. CHP	8pF 50V B		チップセラコン	01
C3504-3515	US064100	C. CE. CHP	0.01uF 50V B	J	チップセラコン	01
C3516-3518	US060800	C. CE. CHP	8pF 50V B	J	チップセラコン	01
C3519	UR237470	C. EL	47uF 16V		ケミコン	01
C3520-3521	US135100	C. CE. CHP	0.1uF 16V		チップセラコン	01
C3522	UR837470	C. EL	47uF 16V		ケミコン	01
C3523	US135100	C. CE. CHP	0.1uF 16V		チップセラコン	01
C3524	UR837470	C. EL	47uF 16V		ケミコン	01
C3525	US135100	C. CE. CHP	0.1uF 16V		チップセラコン	01
C3526	UR837470	C. EL	47uF 16V		ケミコン	01
C3527	US135100	C. CE. CHP	0.1uF 16V		チップセラコン	01
C3528-3530	UR837470	C. EL	47uF 16V		ケミコン	01
C3531-3532	US135100	C. CE. CHP	0.1uF 16V		チップセラコン	01
C3534	US135100	C. CE. CHP	0.1uF 16V	J	チップセラコン	01
C3535	US135100	C. CE. CHP	0.1uF 16V		チップセラコン	01
C3536	UR837470	C. EL	47uF 16V		ケミコン	01
C3537	US135100	C. CE. CHP	0.1uF 16V		チップセラコン	01
C3538	UR837470	C. EL	47uF 16V		ケミコン	01
C3539	US135100	C. CE. CHP	0.1uF 16V		チップセラコン	01
C3540	UR837470	C. EL	47uF 16V		ケミコン	01
C3541	US135100	C. CE. CHP	0.1uF 16V		チップセラコン	01
C3542-3544	UR837470	C. EL	47uF 16V		ケミコン	01
C3545-3547	US135100	C. CE. CHP	0.1uF 16V		チップセラコン	01
C3548	US135100	C. CE. CHP	0.1uF 16V	J	チップセラコン	01
C3550	UR237470	C. EL	47uF 16V		ケミコン	01
C3551-3553	US060300	C. CE. CHP	3pF 50V B		チップセラコン	01
C3554	US135100	C. CE. CHP	0.1uF 16V		チップセラコン	01
C3555	UR837470	C. EL	47uF 16V		ケミコン	01
C3556	UR238330	C. EL	330uF 16V		ケミコン	01
C3558	US135100	C. CE. CHP	0.1uF 16V		チップセラコン	01
C3559	UR837470	C. EL	47uF 16V		ケミコン	01

* New Parts * 新規部品

P.C.B. VIDEO

Ref No.	Part No.	Description	Remarks	Markets	部 品 名	ラック
C3560	US135100	C.CE. CHP			チップセラコン	01
C3561	UR837470	C. EL			ケミコン	01
C3562	US135100	C.CE. CHP			チップセラコン	01
C3563	UR837470	C. EL			ケミコン	01
C3564	US135100	C.CE. CHP			チップセラコン	01
C3565-3566	UR837470	C. EL			ケミコン	01
C3567	US135100	C.CE. CHP			チップセラコン	01
C3568	UR866100	C. EL			ケミコン	01
C3573	US135100	C.CE. CHP			チップセラコン	01
D3002-3003	VT332900	D100E			ダイオード	01
D3502	VT332900	D100E			ダイオード	01
D3504	VT332900	D100E			ダイオード	01
D3506	VT332900	D100E			ダイオード	01
D3510	VT332900	D100E			ダイオード	01
IC301	X8083A00	IC			ロジックIC	02
IC302-303	XY519A00	IC			ロジックIC	02
IC304	XY8719A00	IC			ロジックIC	03
IC305	X8274A00	IC			電源IC	01
IC331	X7378A00	IC			アンプIC	04
IC332-333	X6742A00	IC			アンプIC	04
IC351	X2904A00	IC			アンプIC	06
IC383	XS790A00	IC			ロジックIC	02
IC392	X6757A00	IC			IC	08
JK301-302	WD396100	JACK. PIN			ピンジャック	04
JK303	WD396300	JACK. PIN			ピンジャック	04
PJ351-352	W6471900	JACK. PIN			ピンジャック 6P	03
PN301	WN515200	PIN			スタイルピン	01
03001-3003	VR936300	TR			トランジスタ	01
03004-3006	VV65700	TR. DGT			トランジスタ	01
03300	WH628700	FET			FET	01
03301	VV556400	TR			トランジスタ	01
03501	WC435000	TR. DGT			デジタルトランジスタ	01
R3093-3094	HW754150	R. CAR. FP			不燃化カーボン抵抗	01
R3103-3104	HW753100	R. CAR. FP			不燃化カーボン抵抗	01
R3111	HW753100	R. CAR. FP			不燃化カーボン抵抗	01
R3114-3115	HW753100	R. CAR. FP			不燃化カーボン抵抗	01
R3534	HW753100	R. CAR. FP			不燃化カーボン抵抗	01
R3541	HW753100	R. CAR. FP			不燃化カーボン抵抗	01
R3542	HW753100	R. CAR. FP			不燃化カーボン抵抗	01
R3546	HW753100	R. CAR. FP			不燃化カーボン抵抗	01
R3559	HW753100	R. CAR. FP			不燃化カーボン抵抗	01
ST301	V4040500	SCR. TERM			スタリューターミナル	01
ST351	V4040500	SCR. TERM			スタリューターミナル	01
ST352	V4040500	SCR. TERM			スタリューターミナル	01

* New Parts * 新規部品

Chip Resistors

Value	1/4W Type Part No.	1/6W Type Part No.	Value	1/4W Type Part No.	1/6W Type Part No.
1.0 Ω	HJ35 3100	HF85 3100	10 KΩ	HF45 7100	HF45 7100
1.8 Ω	HJ35 3180	*	11 KΩ	HF45 7110	HF45 7110
2.2 Ω	HJ35 3220	HF85 3220	12 KΩ	HJ35 7120	HF85 7120
3.3 Ω	HJ35 3330	HF85 3330	13 KΩ	HF45 7130	HF45 7130
4.7 Ω	HJ35 3470	HF85 3470	15 KΩ	HF45 7150	HF45 7150
5.6 Ω	HJ35 3560	HF85 3560	18 KΩ	HF45 7180	HF45 7180
10 Ω	HF45 4100	HF45 4100	22 KΩ	HF45 7220	HF45 7220
15 Ω	HJ35 4150	HF85 4150	24 KΩ	HF45 7240	HF45 7240
22 Ω	HF45 4220	HF45 4220	27 KΩ	HJ35 7270	HF85 7270
27 Ω	HJ35 4270	HF85 4270	30 KΩ	HF45 7300	HF45 7300
33 Ω	HF45 4330	HF45 4330	33 KΩ	HF45 7330	HF45 7330
39 Ω	HJ35 4470	HF85 4390	36 KΩ	HF45 7360	HF45 7360
47 Ω	HF45 4470	HF45 4470	39 KΩ	HF45 7390	HF45 7390
56 Ω	HF45 4560	HF45 4560	47 KΩ	HF45 7470	HF45 7470
68 Ω	HF45 4680	HF45 4680	51 KΩ	HF45 7510	HF45 7510
75 Ω	HF45 4750	HF45 4750	56 KΩ	HF45 7560	HF45 7560
82 Ω	HF45 4820	HF45 4820	62 KΩ	HF45 7620	HF45 7620
91 Ω	HF45 4910	HF45 4910	68 KΩ	HF45 7680	HF45 7680
100 Ω	HF45 5100	HF45 5100	82 KΩ	HF45 7820	HF45 7820
110 Ω	HJ35 5110	HF85 5110	91 KΩ	HF45 7910	HF45 7910
120 Ω	HF45 5120	HF45 5120	100 KΩ	HF45 8100	HF45 8100
150 Ω	HF45 5150	HF45 5150	110 KΩ	HF45 8110	HF45 8110
160 Ω	HJ35 5160	*	120 KΩ	HF45 8120	HF45 8120
180 Ω	HF45 5180	HF45 5180	150 KΩ	HF45 8150	HF45 8150
200 Ω	HF45 5200	HF45 5200	180 KΩ	HF45 8180	HF45 8180
220 Ω	HF45 5220	HF45 5220	220 KΩ	HJ35 8220	HF85 8220
270 Ω	HF45 5270	HF45 5270	270 KΩ	HF45 8270	HF45 8270
330 Ω	HF45 5330	HF45 5330	300 KΩ	HF45 8300	HF45 8300
390 Ω	HF45 5390	HF45 5390	330 KΩ	HF45 8330	HF45 8330
430 Ω	HF45 5430	HF45 5430	390 KΩ	HJ35 8390	HF85 8390
470 Ω	HF45 5470	HF45 5470	470 KΩ	HF45 8470	HF45 8470
510 Ω	HF45 5510	HF45 5510	560 KΩ	HJ35 8560	HF85 8560
560 Ω	HF45 5560	HF45 5560	680 KΩ	HJ35 8680	HF85 8680
680 Ω	HF45 5680	HF45 5680	820 KΩ	HJ35 8820	HF85 8820
820 Ω	HF45 5820	HF45 5820	1.0 MΩ	HF45 9100	HF45 9100
910 Ω	HF45 5910	HF45 5910	1.2 MΩ	HJ35 9120	*
1.0 KΩ	HF45 6100	HF45 6100	1.5 MΩ	HJ35 9150	HF85 9150
1.2 KΩ	HF45 6120	HF45 6120	1.8 MΩ	HJ35 9180	HF85 9180
1.5 KΩ	HF45 6150	HF45 6150	2.2 MΩ	HJ35 9220	HF85 9220
1.8 KΩ	HF45 6180	HF45 6180	3.3 MΩ	HJ35 9330	HF85 9330
2.0 KΩ	HJ35 6200	HF85 6200	3.9 MΩ	HJ35 9390	*
2.2 KΩ	HF45 6220	HF45 6220	4.7 MΩ	HJ35 9470	HF85 9470
2.4 KΩ	HJ35 6240	HF85 6240			
2.7 KΩ	HF45 6270	HF45 6270			
3.0 KΩ	HF45 6300	HF45 6300			
3.3 KΩ	HF45 6330	HF45 6330			
3.6 KΩ	HJ35 6360	HF85 6360			
3.9 KΩ	HF45 6390	HF45 6390			
4.7 KΩ	HF45 6470	HF45 6470			
5.1 KΩ	HF45 6510	HF45 6510			
5.6 KΩ	HF45 6560	HF45 6560			
6.8 KΩ	HF45 6680	HF45 6680			
8.2 KΩ	HF45 6820	HF45 6820			
9.1 KΩ	HF45 6910	HF45 6910			

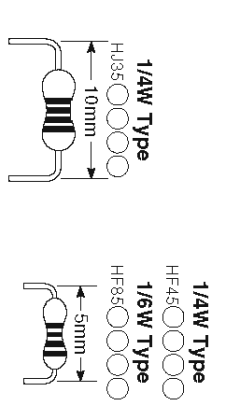

* : Not available

RefNo.	Part No.	Description	Remarks	Markets	部 品 名	ユニット
* 5	WM373100	P.C.B. ASS'Y		J	P C B F U N C T I O N	
* 5	WM373200	P.C.B. ASS'Y		U	P C B F U N C T I O N	
* 5	WM373300	P.C.B. ASS'Y	V863	C	P C B F U N C T I O N	
* 5	WM374100	P.C.B. ASS'Y	6180	C	P C B F U N C T I O N	
* 5	WM373400	P.C.B. ASS'Y		R	P C B F U N C T I O N	
* 5	WM373500	P.C.B. ASS'Y		T	P C B F U N C T I O N	
* 5	WM373600	P.C.B. ASS'Y		K	P C B F U N C T I O N	
* 5	WM373700	P.C.B. ASS'Y		A	P C B F U N C T I O N	
* 5	WM373800	P.C.B. ASS'Y		B	P C B F U N C T I O N	
* 5	WM373900	P.C.B. ASS'Y		GEF	P C B F U N C T I O N	
* 5	WM374000	P.C.B. ASS'Y		L	P C B F U N C T I O N	
* 6	WM250000	P.C.B. ASS'Y	V863	J	P C B D I G I T A L	
* 6	WM250100	P.C.B. ASS'Y		J	P C B D I G I T A L	
* 6	WM252000	P.C.B. ASS'Y	6180	U	P C B D I G I T A L	
* 6	WM250200	P.C.B. ASS'Y	V863	C	P C B D I G I T A L	
* 6	WM252100	P.C.B. ASS'Y	6180	C	P C B D I G I T A L	
* 6	WM250300	P.C.B. ASS'Y		R	P C B D I G I T A L	
* 6	WM250400	P.C.B. ASS'Y		T	P C B D I G I T A L	
* 6	WM251000	P.C.B. ASS'Y		K	P C B D I G I T A L	
* 6	WM251100	P.C.B. ASS'Y		A	P C B D I G I T A L	
* 6	WM251200	P.C.B. ASS'Y		B	P C B D I G I T A L	
* 6	WM251300	P.C.B. ASS'Y	V863	GEF	P C B D I G I T A L	
* 6	WM252200	P.C.B. ASS'Y	6180	F	P C B D I G I T A L	
* 6	WM251400	P.C.B. ASS'Y		L	P C B D I G I T A L	
* 7	WM374500	P.C.B. ASS'Y		J	P C B V I D E O	
* 7	WM374500	P.C.B. ASS'Y		U	P C B V I D E O	
11	WK971200	HD RADIO TUNER		U	H D チ ュ ー ナ ー	
12	WB877200	AM/FM TUNER		J	A M / F M チ ュ ー ナ ー	12
12	WB877300	AM/FM TUNER		J	A M / F M チ ュ ー ナ ー	
12	WB877400	AM/FM TUNER		CRTL	A M / F M チ ュ ー ナ ー	
15	X9625A00	POWER TRANSFORMER		KAGEF	A M / F M チ ュ ー ナ ー	
* 15	X9629A00	POWER TRANSFORMER		J	電 源 ト ラ ン ス	
* 15	X9630A00	POWER TRANSFORMER		UC	電 源 ト ラ ン ス	
* 15	X9668A00	POWER TRANSFORMER		RL	電 源 ト ラ ン ス	
* 15	X9669A00	POWER TRANSFORMER		TK	電 源 ト ラ ン ス	
* 15	X9628A00	POWER TRANSFORMER		A	電 源 ト ラ ン ス	
* 16	V9293500	POWER CABLE		BGEF	電 源 ト ラ ン ス	
* 16	WC992700	POWER CABLE		UC	電 源 コ ー ド	
* 16	WB120600	POWER CABLE		R	電 源 コ ー ド	
* 16	WC753000	POWER CABLE		T	電 源 コ ー ド	
* 16	WC743700	POWER CABLE		K	電 源 コ ー ド	
* 16	WB212200	POWER CABLE		A	電 源 コ ー ド	
* 16	V9293600	POWER CABLE		B	電 源 コ ー ド	
17	V2438700	CORD STOPPER		GEFL	電 源 コ ー ド	
26	ME113120	FLEXIBLE FLAT CABLE		UCRTKABGEFL	コ ー ド ス ト ッ パ ー	02
27	WP241800	FLEXIBLE FLAT CABLE		JCRTKAGEFL	カ ー ド 電 線 C & C	01
* 28	ME124070	FLEXIBLE FLAT CABLE		U	カ ー ド 電 線 C & C	
* 29	ME124070	FLEXIBLE FLAT CABLE		C	カ ー ド 電 線 C & C	
* 30	WP242000	FLEXIBLE FLAT CABLE		R	カ ー ド 電 線 C & C	
101	W3364700	TOP COVER		GD	カ ー ド 電 線 C & C	11
101	W3364600	TOP COVER		BL	カ ー ド 電 線 C & C	
101	W3364800	TOP COVER		TI	カ ー ド 電 線 C & C	
103	WM734900	REAR PANEL	AX863	J	カ ー ド 電 線 C & C	
103	WM734000	REAR PANEL	V863	U	カ ー ド 電 線 C & C	
103	WM734100	REAR PANEL	V863	C	カ ー ド 電 線 C & C	
103	WM734200	REAR PANEL	V863	R	カ ー ド 電 線 C & C	
103	WM734300	REAR PANEL	V863	T	カ ー ド 電 線 C & C	
103	WM734400	REAR PANEL	V863	K	カ ー ド 電 線 C & C	
103	WM734500	REAR PANEL	V863	A	カ ー ド 電 線 C & C	
103	WM734600	REAR PANEL	AX863SE	B	カ ー ド 電 線 C & C	

* New Parts * 新規部品

RefNo.	Part No.	Description	Remarks	Markets	部 品 名	ユニット
* 103	WM734700	REAR PANEL		GEF	リヤパネル	
* 103	WM734800	REAR PANEL	V863	L	リヤパネル	
* 103	WM735000	REAR PANEL	6180	U	リヤパネル	
* 103	WM735100	REAR PANEL	6180	C	リヤパネル	
* 103	WM735200	REAR PANEL	6180	F	リヤパネル	
105	WK437600	PLATE SIDE		GD	プレートサイド	
105	WK437500	PLATE SIDE		BL	プレートサイド	
105	WK437700	PLATE SIDE		TI	プレートサイド	
112	WM738000	SUPPORT PCB/F		GD	サポート PCB/F	
120	V0042500	LEG		BL, TI	レッグ	03
120	V5025000	LEG		GD	レッグ	02
121	WJ181400	KNOB D50		GD	ノブ D 5 0	
121	WJ181300	KNOB D50		BL	ノブ D 5 0	
121	WJ181500	KNOB D50		TI	ノブ D 5 0	
122	WJ182100	KNOB D20		GD	ノブ D 2 0	02
122	WJ182000	KNOB D20		BL	ノブ D 2 0	
122	WJ182200	KNOB D20		TI	ノブ D 2 0	
131	WK667900	SHEET TOP		RTKABGEF	シート トップ	
133	V6742300	DAMPER		RTKABGEF	ダンパー	
135	WE812900	DAMPER		RTKABGEF	ダンパー	
139	WC879000	DAMPER		RTKABGEF	ダンパー	
155	V0368600	PUSH RIVET		RTKABGEF	押しリベット	01
156	WJ053800	RIVET TOP		RTKABGEF	リベット トップ	
160	WE74100	BIND HEAD BONDING B-T. SCREW		RTKABGEF	ボンドヘッド B タイトネジ	01
163	WE74300	BIND HEAD B-TIGHT SCREW		RTKABGEF	ボンドヘッド B タイトネジ	01
167	WE02600	PM HEAD B-TIGHT SCREW		RTKABGEF	PWヘッド B タイトネジ	01
168	WH010900	SCREW IC		RTKABGEF	スクルー IC	01
170	WE74700	BIND HEAD S-TIGHT SCREW		GD, TI	ボンドヘッド S タイトネジ	01
171	V0069600	PM HEAD S-TIGHT SCREW		BL	PWヘッド S タイトネジ	01
171	VH313200	DISH HEAD S-TIGHT SCREW		GD, TI	DISH B タイトネジ	01
172	WE200400	DISH HEAD B-TIGHT SCREW		BL	DISH B タイトネジ	01
172	WE200500	DISH HEAD B-TIGHT SCREW		BL	DISH B タイトネジ	01
173	WE74800	BIND HEAD P-TIGHT SCREW		BL	ボンドヘッド P タイトネジ	01
176	AA627310	GROUND TERMINAL		GD	GNDターミナル	01
200	WM873900	ACCESSORIES		JRTAL	付属品	
200	WM873800	REMOTE CONTROL		UC	リモコン	
200-1	AA776600	BATTERY COVER		JCRTAL	電池蓋	04
201	AA85300	REMOTE CONTROL		KBGEF	リモコン	
201-1	AA859640	BATTERY COVER		KBGEF	電池蓋	02
202	V6267000	INDOOR FM ANTENNA		JUCRTL	FM簡易アンテナ	03
202	V0147100	AM LOOP ANTENNA		KAGEF	FM簡易アンテナ	02
203	VE248500	AM LOOP ANTENNA		JCRTKAGEFL	AMループアンテナ	03
203	WE746800	OPTIMIZER MICROPHONE		U	オプティマイザーマイク	08
204	WJ264300	POWER CABLE		J	電源コード	07
205	WA642300	BATTERY		KBGEF	単 4 乾電池	
	AA777610	SERVICE TOOLS			サービス用品	
	ME116400	RS232C CONVERSION ADAPTER			RS 2 3 2 C 変換アダプタ	
	ME125400	FLEXIBLE FLAT CABLE			カー ド電線 C & C	
	ME126500	FLEXIBLE FLAT CABLE			カー ド電線 C & C	

* New Parts * 新規部品

• FRONT PANEL and SUB CHASSIS UNIT

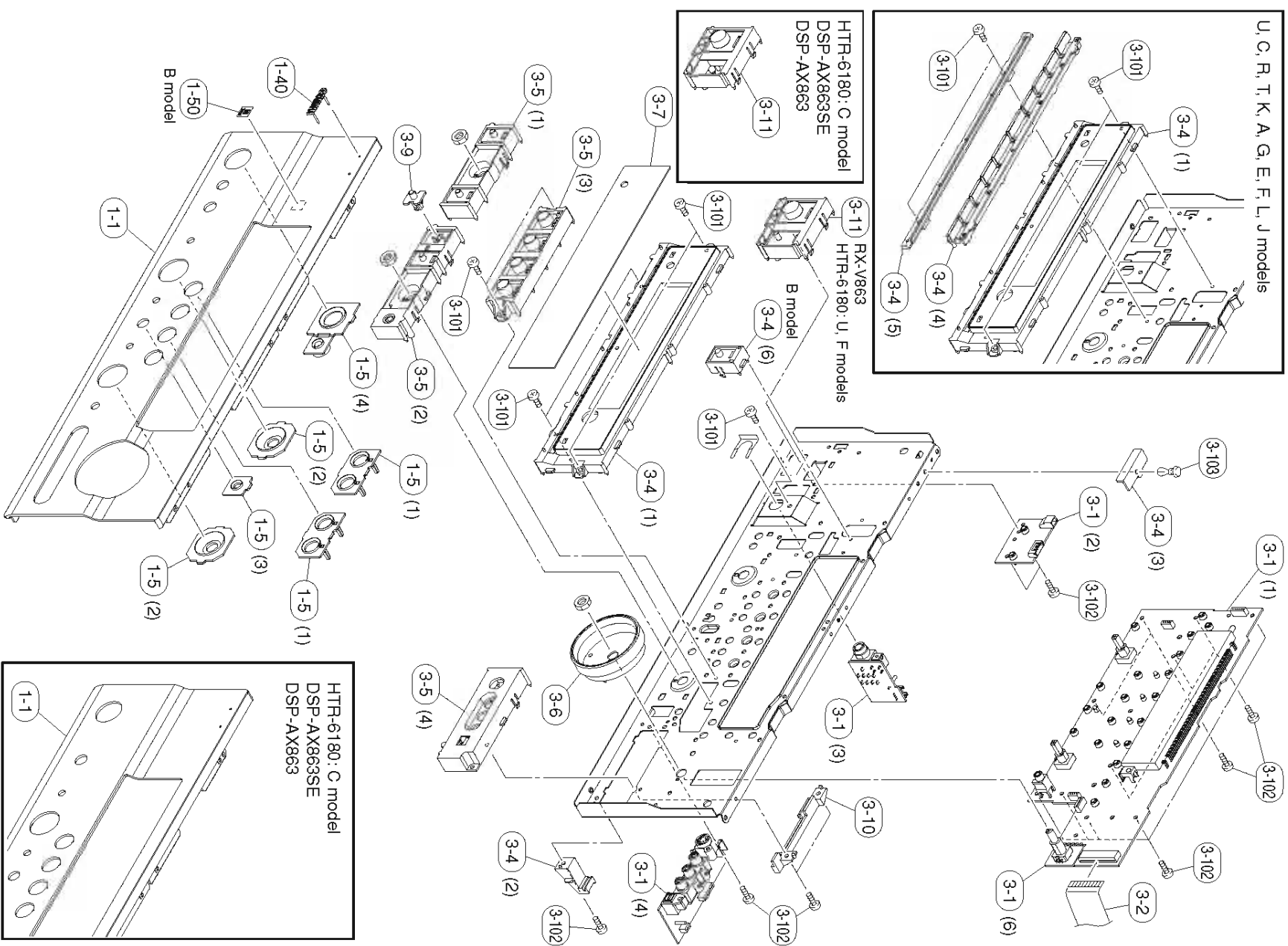

RefNo.	Part No.	Description	Remarks	Markets	部 品 名	ラック
1-1	NM739100	FRONT PANEL	AX863GD	J	フロントパネル	
1-1	NM739000	FRONT PANEL	V863GD	RTK	フロントパネル	
1-1	NM958500	FRONT PANEL	AX863BL	J	フロントパネル	
1-1	NM738200	FRONT PANEL	V863BL	UC	フロントパネル	
1-1	NM738300	FRONT PANEL	V863BL	RAGEF	フロントパネル	
1-1	NM958400	FRONT PANEL	AX863SERL	B	フロントパネル	
1-1	NM739600	FRONT PANEL	AX863SETI	B	フロントパネル	
1-1	NM739500	FRONT PANEL	V863TI	GEFL	フロントパネル	
1-1	NM738400	FRONT PANEL	6180BL	U	フロントパネル	
1-1	NM958600	FRONT PANEL	6180BL	C	フロントパネル	
1-1	NM738500	FRONT PANEL	6180BL	F	フロントパネル	
1-5	NM740600	ESCUTCHEON ASS'Y	GD		エスカッションASSY	
1-5	NM740500	ESCUTCHEON ASS'Y	BL		エスカッションASSY	
1-5	NM740700	ESCUTCHEON ASS'Y	TI		エスカッションASSY	
1-40	V6034200	EMBLEM	GD		エンブレム	
1-40	V6034100	EMBLEM	BL, TI		エンブレム	
1-50	WE765700	BADGE		B	バッジ	
3-1	NM378100	P.C.B. ASS'Y		J	PCB OPERATION	
3-1	NM378200	P.C.B. ASS'Y		URTKAGEFL	PCB OPERATION	
3-1	NM378200	P.C.B. ASS'Y	V863	C	PCB OPERATION	
3-1	NM378400	P.C.B. ASS'Y	6180	C	PCB OPERATION	
3-1	NM378300	P.C.B. ASS'Y		B	PCB OPERATION	
3-2	NP242200	FLEXIBLE FLAT CABLE			カーダ電線 C&C	
3-4	KJ183200	SUBPANEL		JUCRTKAGEFL	サブパネル	
3-4	KJ183300	SUBPANEL		B	サブパネル	
3-5	NM741300	BUTTON CASE 863	GD		ボタンスケース863	
3-5	NM741100	BUTTON CASE 863	BL		ボタンスケース863	
3-5	NM741400	BUTTON CASE 863	TI		ボタンスケース863	
3-6	NM737500	ESCUTCHEON VOL	GD		エスカッションVOL	
3-6	NM737400	ESCUTCHEON VOL	BL		エスカッションVOL	
3-6	NM737600	ESCUTCHEON VOL	TI		エスカッションVOL	
3-7	NM741800	SHEET WINDOW	V863		シートウインドウ	
3-7	NM741500	SHEET WINDOW	6180		シートウインドウ	
3-7	NM081600	SHEET WINDOW		C	シートウインドウ	
3-7	NM741900	SHEET WINDOW		C	シートウインドウ	
3-7	NM741600	SHEET WINDOW		RTKAGEFL	シートウインドウ	
3-7	NM741700	SHEET WINDOW		B	シートウインドウ	
3-9	KJ184100	LENS BUTTON			ボタンスレンズ	
3-10	KJ917000	SUPPORT AUX	GD		サポーターAUX	
3-10	KJ916900	SUPPORT AUX	BL		サポーターAUX	
3-10	KJ917100	SUPPORT AUX	TI		サポーターAUX	
3-11	NM736900	BUTTON STANDBY	AX863GD		ボタンスタンドバイ	
3-11	NM736700	BUTTON STANDBY	AX863BL		ボタンスタンドバイ	
3-11	NM737100	BUTTON STANDBY	AX863TI		ボタンスタンドバイ	
3-11	NM736800	BUTTON MAIN	6180BL	C	ボタンスタンドバイ	
3-11	NM736600	BUTTON MAIN	V863GD		ボタンスタンドバイ	
3-11	NM737000	BUTTON MAIN	V863BL		ボタンスタンドバイ	
3-11	NM736600	BUTTON MAIN	V863TI		ボタンスタンドバイ	
3-11	NM737000	BUTTON MAIN	6180BL	UF	ボタンスタンドバイ	
3-25	WE74200	BLIND HEAD B-TIGHT SCREW			バインドヘッドボタントネジ	
3-101	WE774300	BLIND HEAD B-TIGHT SCREW			バインドヘッドボタントネジ	
3-102	WE774800	BLIND HEAD P-TIGHT SCREW			バインドヘッドボタントネジ	
3-103	V0368600	PUSH RIVET			プッシュエリベット	

• AMP UNIT

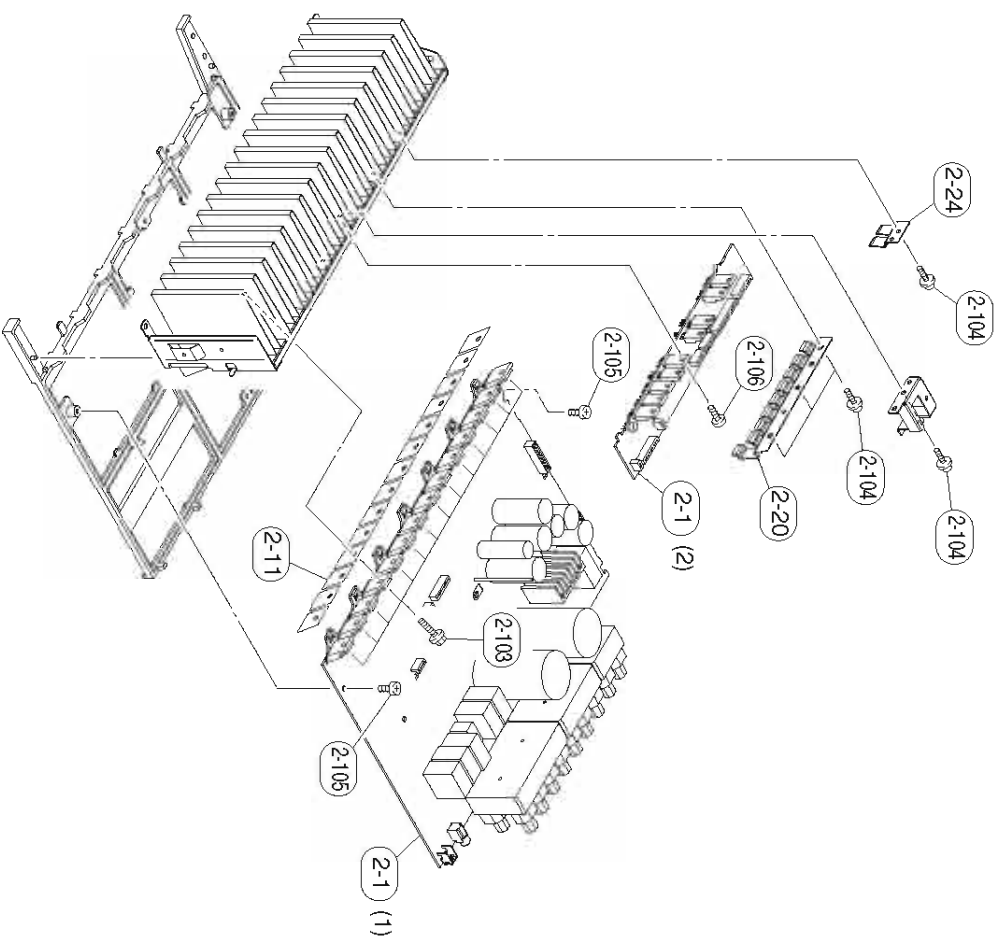

Ref No.	Part No.	Description	Remarks	Markets	部 品 名	ラック
2-1	WN371600	P.C.B. ASS'Y		J	P CB MAIN	
2-1	WN371700	P.C.B. ASS'Y		U	P CB MAIN	
2-1	WN371800	P.C.B. ASS'Y		C	P CB MAIN	
2-1	WN372200	P.C.B. ASS'Y	V863 6180	C	P CB MAIN	
2-1	WN371900	P.C.B. ASS'Y		RTA	P CB MAIN	
2-1	WN372000	P.C.B. ASS'Y		KSEFL	P CB MAIN	
2-1	WN372100	P.C.B. ASS'Y		B	P CB MAIN	
2-11	WM280900	MICA SHEET			マイカシート	
2-20	WG440600	SUPPORT TR-8P			サポートTR-8P	04
2-24	WJ402000	SUPPORT TR-2P			サポートTR-2P	01
2-103	WM220800	HEXAGONAL HEAD B-TIGHT SCREW			六角Bタイトネジ	01
2-104	WE002600	PH HEAD B-TIGHT SCREW			PWヘッドBタイトネジ	01
2-105	WE774800	PH HEAD P-TIGHT SCREW			パインドPタイトネジ	01
2-106	WE774300	PH HEAD B-TIGHT SCREW			パインドBタイトネジ	01

* New Parts * 新規部品

REMOTE CONTROL
RAV329 (U, C models), RAV330 (R, T, A, L, J models)
 • SCHEMATIC DIAGRAM

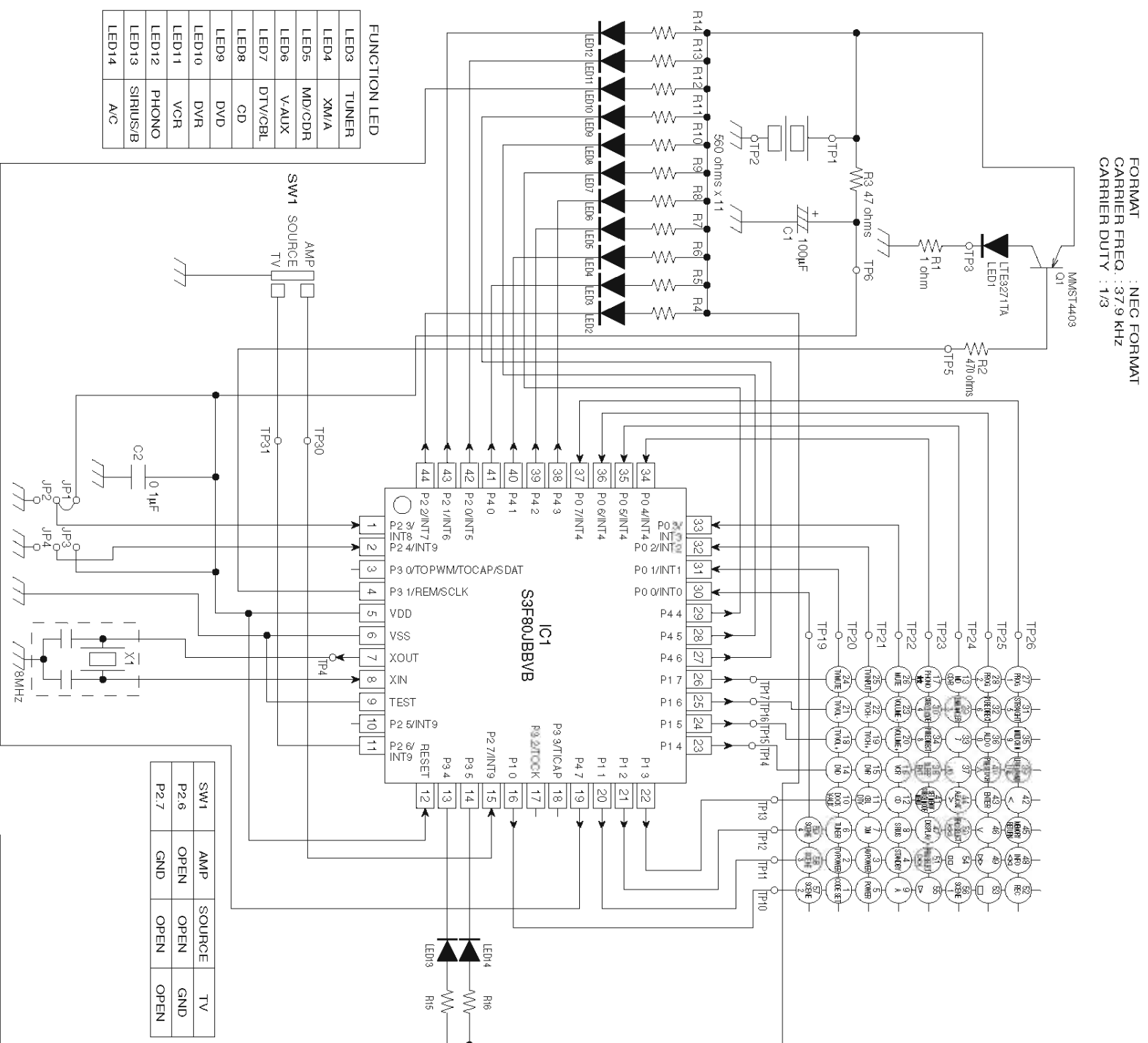

• PANELS

RAV329 (U, C models)

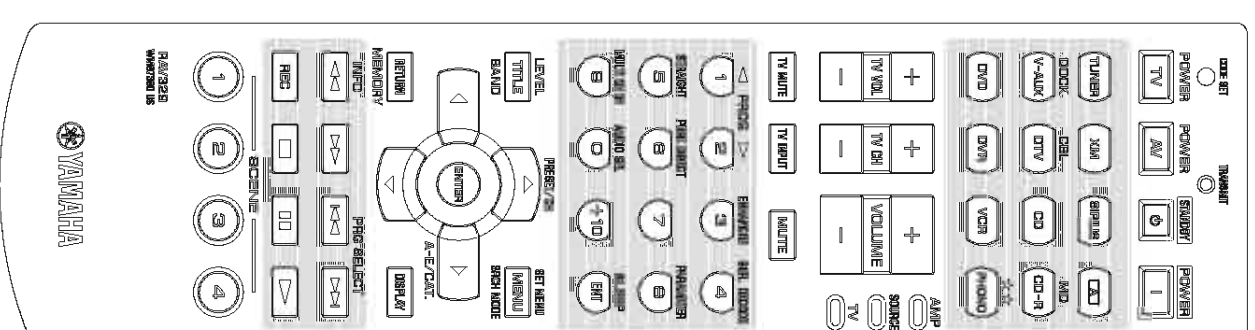

RAV330 (R, T, A, L, J models)

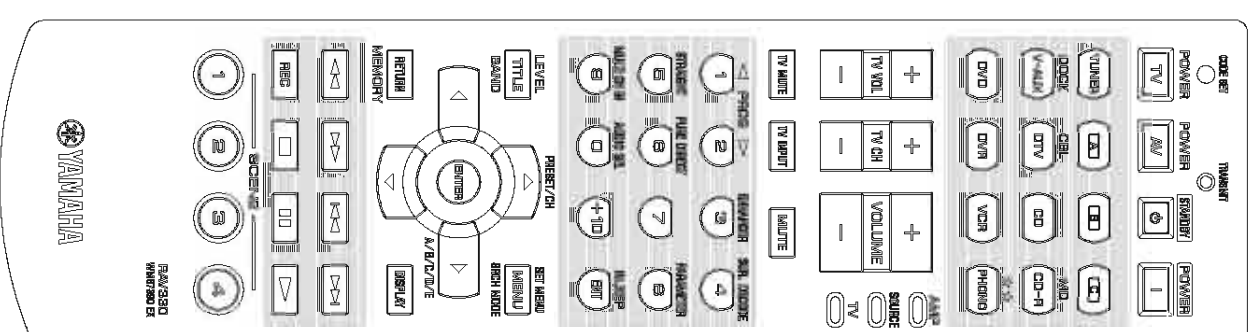

FUNCTION LED

LED3	TUNER
LED4	XM/A
LED5	MD/CDR
LED6	V-AUX
LED7	DTV/GBL
LED8	CD
LED9	DVD
LED10	DVR
LED11	VCR
LED12	PHONO
LED13	SIRIUS/B
LED14	A/C

SW1	AMP	SOURCE	TV
P2.6	OPEN	OPEN	GND
P2.7	GND	OPEN	OPEN

JP1	AMP	SOURCE	TV
JP2	ON	OFF	OFF
JP3	OFF	OFF	OFF
JP4	OFF	OFF	OFF

RAV329, 330	ON	OFF	OFF	OFF
P2.3	VDD	GND
P2.4				

A B C D E F G H I J

1 • KEY LAYOUT

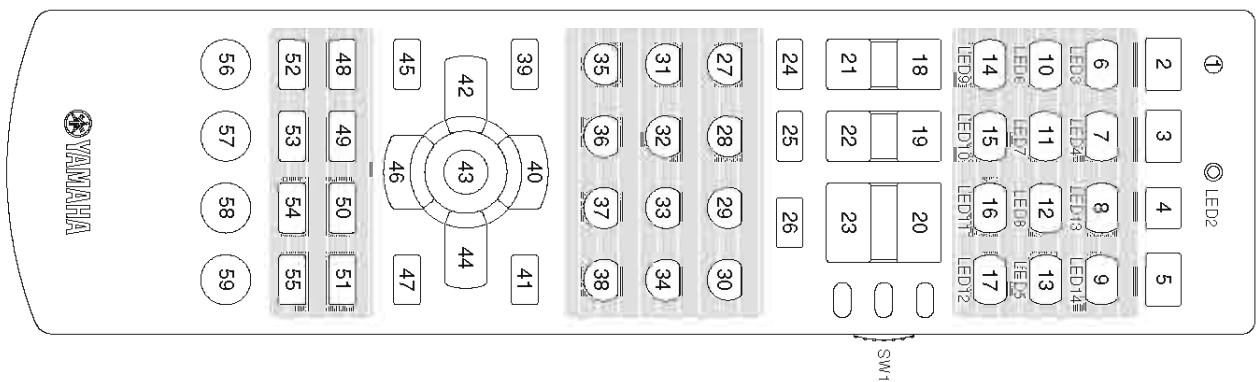

• KEY CODE

No.	Label	Yamaha receiver				Yamaha LD	Yamaha D-tuner		Yamaha Misc Audio		Yamaha DVD	Yamaha DVD-R	Yamaha Tape	Universal CD-R	Yamaha CD
		ID1	ZONE2	MAIN	ZONE2		ID1	ID2	ID1	ID2					
1	TRANSMIT (LED2)	-	-	-	-	140127	829151	829181	821761	829611	425431	525441	[70542]	[71292]	629071
2	CODE SET	-	-	-	-	N-1	-	N-2	-	-	N-1	-	-	-	
3	STANDBY	7E-7F	7E-B8	7E-7F81	7E-BB45	-	-	-	-	-	-	-	-	-	
4	POWER	7E-7E	7E-BA	7E-7E80	7E-BA44	-	-	-	-	-	-	-	-	-	
5	TUNER	7A-16	7A-D2	7A-16E8	7A-D22C	-	-	-	-	-	-	-	-	-	
6	XM (RAV329)	7A-B4	7A-B8	7A-B44A	7A-B846	-	-	-	-	-	-	-	-	-	
7	A (RAV330)	-	-	-	-	-	-	-	-	-	-	-	-	-	
8	SIRIUS (RAV329)	7A-39	7A-3A	7A-39C7	7A-3AC4	-	-	-	-	-	-	-	-	-	
9	B (RAV330)	7F01-3F	7F01-40	7F01-3FC1	7F01-40BE	-	-	-	-	-	-	-	-	-	
10	V-AUX/DOCK	7A-55	7A-D8	7A-55AB	7A-D826	-	-	-	-	-	-	-	-	-	
11	D1/VCBL	7A-54	7A-D9	7A-54AA	7A-D927	-	-	-	-	-	-	-	-	-	
12	CD	7A-15	7A-D1	7A-15EB	7A-D12F	-	-	-	-	-	-	-	-	-	
13	MD/CD-R	7A-C9	7A-CF	7A-C937	7A-CF31	-	-	-	-	-	-	-	-	-	
14	DVD	7A-C1	7A-CD	7A-C13E	7A-CD33	-	-	-	-	-	-	-	-	-	
15	DVR	7A-13	7A-D7	7A-13ED	7A-D729	-	-	-	-	-	-	-	-	-	
16	VCR	7A-0F	7A-D6	7A-0FF1	7A-D628	-	-	-	-	-	-	-	-	-	
17	PHONO	7A-14	7A-D0	7A-14EA	7A-D02E	-	-	-	-	-	-	-	-	-	
18	AV POWER	-	-	-	-	-	-	-	-	-	-	-	-	-	
19	TV VOL. up	-	-	-	-	-	-	-	-	-	-	-	-	-	
20	TV CH up	7A-1A	7A-DA	7A-1AE4	7A-DA24	-	-	-	-	-	-	-	-	-	
21	TV VOL. down	-	-	-	-	-	-	-	-	-	-	-	-	-	
22	TV CH down	-	-	-	-	-	-	-	-	-	-	-	-	-	
23	VOL. down	7A-1B	7A-DB	7A-1BE5	7A-DB25	-	-	-	-	-	-	-	-	-	
24	TV MUTE	-	-	-	-	-	-	-	-	-	-	-	-	-	
25	TV INPUT	-	-	-	-	-	-	-	-	-	-	-	-	-	
26	MUTE	7A-1C	7A-DC	7A-1CE2	7A-DC22	-	-	-	-	-	-	-	-	-	
27	PHOG +	7A-59	7A-5A	7A-59AF	7A-5A27	-	-	-	-	-	-	-	-	-	
28	PHOG -	7A-58	7A-59	7A-58AF	7A-5927	-	-	-	-	-	-	-	-	-	
29	ENHANCER	7A-94	7A-9A	7A-946A	7A-9A29	-	-	-	-	-	-	-	-	-	
30	SUR DECODE	7A-8D	7A-8D	7A-8D03	7A-8D03	-	-	-	-	-	-	-	-	-	
31	STRAIGHT	7A-56	7A-56	7A-5668	7A-5668	-	-	-	-	-	-	-	-	-	
32	PURE DIRECT	7A-DD	7A-DD	7A-DD23	7A-DD23	-	-	-	-	-	-	-	-	-	
33	-	7A-95	7A-95	7A-956B	7A-956B	-	-	-	-	-	-	-	-	-	
34	PARAMETER	7A-C4	7A-C4	7A-C42A	7A-C42A	-	-	-	-	-	-	-	-	-	
35	MULTI CH IN	7A-87	7A-87	7A-8719	7A-8719	-	-	-	-	-	-	-	-	-	
36	AUDIO SEL	7A-C3	7A-C3	7A-C33D	7A-C33D	-	-	-	-	-	-	-	-	-	
37	-	-	-	-	-	-	-	-	-	-	-	-	-	-	
38	SLEEP	7A-57	7A-57	7A-57A9	7A-57A9	-	-	-	-	-	-	-	-	-	
39	LEVEL	7A-86	7A-86	7A-8673	7A-8673	-	-	-	-	-	-	-	-	-	
40	UP	7A-9D	7A-9D	7A-9D63	7A-9D63	-	-	-	-	-	-	-	-	-	
41	SET MENU	7A-84	7A-84	7A-847A	7A-847A	-	-	-	-	-	-	-	-	-	
42	Left	7A-9F	7A-9F	7A-9F61	7A-9F61	-	-	-	-	-	-	-	-	-	
43	ENTER	7A-DE	7A-DE	7A-DE20	7A-DE20	-	-	-	-	-	-	-	-	-	
44	Right	7A-9E	7A-9E	7A-9E60	7A-9E60	-	-	-	-	-	-	-	-	-	
45	RETURN	7A-AA	7A-AA	7A-AA64	7A-AA64	-	-	-	-	-	-	-	-	-	
46	Down	7A-9C	7A-9C	7A-9C62	7A-9C62	-	-	-	-	-	-	-	-	-	
47	DISPLAY	7A-C2	7A-C2	7A-C23C	7A-C23C	-	-	-	-	-	-	-	-	-	
48	REW (Search)	-	-	-	-	-	-	-	-	-	-	-	-	-	
49	FF (Search)	-	-	-	-	-	-	-	-	-	-	-	-	-	
50	CHP/Skip	-	-	-	-	-	-	-	-	-	-	-	-	-	
51	CHP/Skip+	-	-	-	-	-	-	-	-	-	-	-	-	-	
52	REC	-	-	-	-	-	-	-	-	-	-	-	-	-	
53	Stop	-	-	-	-	-	-	-	-	-	-	-	-	-	
54	Pause	-	-	-	-	-	-	-	-	-	-	-	-	-	
55	Play	-	-	-	-	-	-	-	-	-	-	-	-	-	
56	SCENE1	7A-007F	7A-017E	7A-007E	7A-017F	-	-	-	-	-	-	-	-	-	
57	SCENE2	7A-037C	7A-047B	7A-037D	7A-047A	-	-	-	-	-	-	-	-	-	
58	SCENE3	7A-0679	7A-0778	7A-0678	7A-0779	-	-	-	-	-	-	-	-	-	
59	SCENE4	7A-0976	7A-0A75	7A-0977	7A-0A74	-	-	-	-	-	-	-	-	-	

Mode	Default Device
Receiver (Slide switch-AMP)	00001: Yamaha Receiver
CD (Default: slide switch-Source)	62907: Yamaha CD
MD/CD	71292: Yamaha CD-R
XM	82918: Yamaha Digital Tuner *1
SIRIUS	82176: Yamaha Digital Tuner *1
DVD	42543: Yamaha DVD
DVD	52544: Yamaha DVD-R
D1/VCBL	None (can be set as a DVD, DVD-R, VCR, PVR, TV, GBL, SAT, LD, CD, CD-R, MD, Tape and Tuner)
TUNER	82915: Yamaha Tuner
VCR	None (can be set as a DVD, DVD-R, VCR, PVR, TV, GBL, SAT, LD, CD, CD-R, MD, Tape and Tuner)
V-AUX/DOCK	52544: Yamaha DVD-R
NET	82981: Yamaha MISC Audio
PHONO	82982: Yamaha MISC Audio
TV (slide switch-TV)	None (can be set as a DVD, DVD-R, VCR, PVR, TV, GBL, SAT, LD, CD, CD-R, MD, Tape and Tuner)

Note *1: Default ID will vary upon jumper setting.

● RAV372 (K, B, G, E, F models)
 • SCHEMATIC DIAGRAM

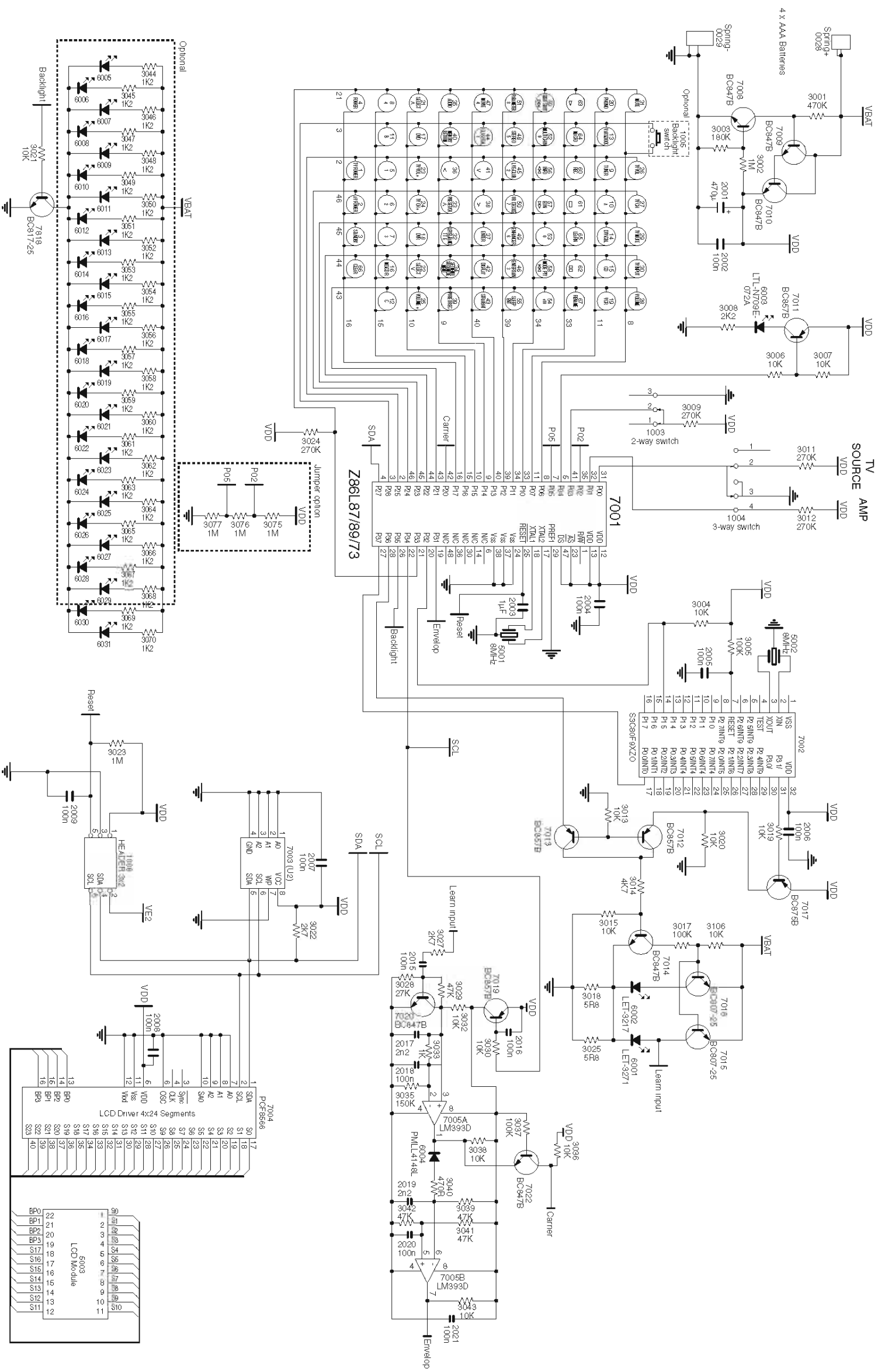

• PANELS

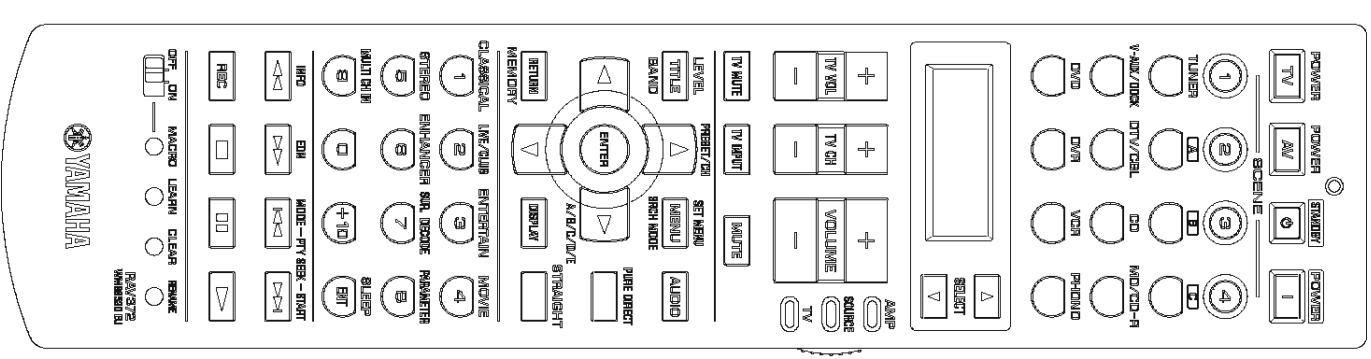

Advanced setup

This unit has additional menus that are displayed in the front panel display. The advanced setup menu offers additional operations to adjust and customize the way this unit operates. Change the initial settings (indicated in bold under each parameter) to reflect the needs of your listening environment.

Notes

- The settings you make are reflected next time you press **MAIN ZONE ON/OFF** to turn on this unit.
- Only **MAIN ZONE ON/OFF**, **SYSTEM OFF**, **TONE CONTROL** and the **PROGRAM** selector are effective while you are using the advanced setup menu.
- No other operations can be made while you are using the advanced setup menu.
- The advanced setup menu is only available in the front panel display.

Using the advanced setup

1 Press **SYSTEM OFF** on the front panel to set this unit to the standby mode.

2 Press and hold **TONE CONTROL** and then press **MAIN ZONE ON/OFF** to turn on this unit. This unit turns on, and the advanced setup menu appears in the front panel display.



3 Rotate the **PROGRAM** selector to select the parameter you want to adjust. The name of the selected parameter appears in the front panel display.

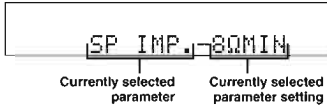

4 Press **TONE CONTROL** repeatedly to change the selected parameter setting.

5 Press **SYSTEM OFF** to save the new setting and set this unit to the standby mode.

The settings you made are reflected next time you turn on this unit.

Speaker impedance SP IMP.

Use this feature to set the speaker impedance of this unit so that it matches that of your speakers. Choices: **8Ω MIN**, **6Ω MIN**

- Select "8Ω MIN" to set the speaker impedance to 8 Ω.
- Select "6Ω MIN" to set the speaker impedance to 6 Ω.

SP IMP.	Speaker	Impedance level
8ΩMIN	Front	If you use one set (A or B), the impedance of each speaker must be 8 Ω or higher. If you use two sets (A and B), the impedance of each speaker must be 16 Ω or higher.*
	Center	
	Surround	The impedance of each speaker must be 8 Ω or higher.
	Surround back	
6ΩMIN	Front	If you use one set (A or B), the impedance of each speaker must be 4 Ω or higher. If you use two sets (A and B), the impedance of each speaker must be 8 Ω or higher.
	Center	
	Surround	The impedance of each speaker must be 6 Ω or higher.
	Surround back	

* The Canada model cannot use two separate speaker systems (A and B) simultaneously when "SP IMP" is set to "8ΩMIN".

ADVANCED OPERATION

English

REMOTE CONTROL RAV329/330

Advanced setup

Remote control AMP ID REMOTE AMP

Use this feature to set the AMP ID of this unit for remote control recognition. This feature is useful when you operate this unit and the other Yamaha receivers/ amplifiers in the same room separately. Choices: ID1, ID2

- Select "ID1" when the remote control AMP ID code is set to "00001".
- Select "ID2" when the remote control AMP ID code is set to "00002".

Setting remote control AMP ID codes

You need to set the remote control AMP ID code for the remote control.

1 Press **CODE SET** using a ballpoint pen or a similar object. The **TRANSMIT** indicator on the remote control flashes twice.



2 Press the numeric buttons to enter the code number "00001" or "00002". The **TRANSMIT** indicator on the remote control flashes twice, and the AMP ID code is changed.

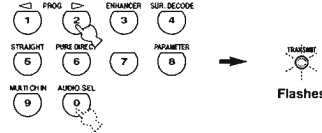

AMP ID code *1	Function	Remote control AMP ID *2
00001 (initial setting)	To operate this unit using the default code.	ID1 (initial setting)
00002	To operate this unit using an alternative code.	ID2

*1 The remote control setting
*2 The setting of this unit

Remote control TUNER ID REMOTE TU

Use this feature to set the TUNER ID of this unit for remote control recognition. Choices: ID1, ID2

- Select "ID1" when the remote control TUNER ID code is set to "82915".
- Select "ID2" when the remote control TUNER ID code is set to "82178".

Setting remote control TUNER ID codes

You need to set the remote control TUNER ID library code for the remote control.

1 Press **TUNER** to select "TUNER" as the input source.



2 Press **CODE SET** using a ballpoint pen or a similar object. The **TRANSMIT** indicator on the remote control flashes twice.



3 Press the numeric buttons to enter the code number "82915" or "82178". The **TRANSMIT** indicator on the remote control flashes twice, and the TUNER ID code is changed.

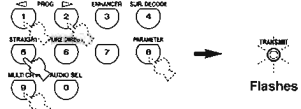

TUNER ID code *1	Function	Remote control TUNER ID *2
82915 (initial setting)	To operate this unit using the default code.	ID1 (initial setting)
82178	To operate this unit using an alternative code.	ID2

*1 The remote control setting
*2 The setting of this unit

REMOTE CONTROL RAV329/330

Advanced setup

Remote control XM ID REMOTE XM (U.S.A. and Canada models only)

Use this feature to set the XM ID of this unit for remote control recognition. Choices: ID1, ID2

- Select "ID1" when the remote control XM ID code is set to "82918".
- Select "ID2" when the remote control XM ID code is set to "82179".

Setting remote control XM ID codes

You need to set the remote control XM ID code for the remote control.

1 Press **XM** to select "XM" as the input source.



2 Press **CODE SET** using a ballpoint pen or a similar object. The **TRANSMIT** indicator on the remote control flashes twice.

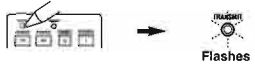

3 Press the numeric buttons to enter the code number "82918" or "82179". The **TRANSMIT** indicator on the remote control flashes twice, and the XM ID code is changed.

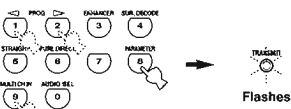

XM ID code *1	Function	Remote control XM ID *2
82918 (initial setting)	To operate this unit using the default code.	ID1 (initial setting)
82179	To operate this unit using an alternative code.	ID2

*1 The remote control setting
*2 The setting of this unit

Remote control SIRIUS ID REMOTE SR (U.S.A. and Canada models only)

Use this feature to set the SIRIUS ID of this unit for remote control recognition. Choices: ID1, ID2

- Select "ID1" when the remote control SIRIUS ID code is set to "82176".
- Select "ID2" when the remote control SIRIUS ID code is set to "82177".

Setting remote control SIRIUS ID codes

You need to set the remote control SIRIUS ID code for the remote control.

1 Press **TUNER** to select "SIRIUS" as the input source.



2 Press **CODE SET** using a ballpoint pen or a similar object. The **TRANSMIT** indicator on the remote control flashes twice.

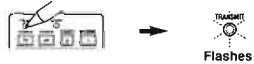

3 Press the numeric buttons to enter the code number "82176" or "82177". The **TRANSMIT** indicator on the remote control flashes twice, and the SIRIUS ID code is changed.

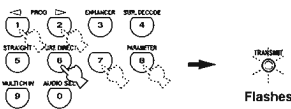

SIRIUS ID code *1	Function	Remote control SIRIUS ID *2
82176 (initial setting)	To operate this unit using the default code.	ID1 (initial setting)
82177	To operate this unit using an alternative code.	ID2

*1 The remote control setting
*2 The setting of this unit

ADVANCED OPERATION

English

REMOTE CONTROL RAV372

Advanced setup

Remote control AMP ID REMOTE AMP

Use this feature to set the AMP ID of this unit for remote control recognition. This feature is useful when you operate this unit and the other Yamaha receivers/ amplifiers in the same room separately. Choices: ID1, ID2

- Select "ID1" when the remote control AMP ID code is set to "2201".
- Select "ID2" when the remote control AMP ID code is set to "2202".

Setting remote control AMP ID codes

You need to set the remote control AMP ID code for the remote control.

1 Set the operation mode selector to **AMP** or **SOURCE**.



2 Press and hold **LEARN** for about 3 seconds using a ballpoint pen or similar object and then press **◀/▶** repeatedly until "L:AMP" appears in the display window on the remote control.

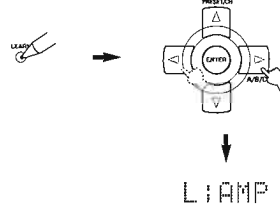

Notes

- Be sure to press and hold **LEARN** for at least 3 seconds, otherwise the learning process will start.
- If you do not complete each of the following steps within 30 seconds, the setting mode will be automatically canceled. In this case, start over from step 1.

3 Press **ENTER**.

The four-digit code set for the selected input area appears in the display window on the remote control.

4 Press the numeric buttons to enter the four-digit remote control code for the input area you want to use.

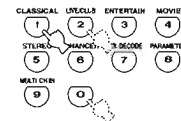

Remote control AMP ID codes

Select one of the following codes to set the remote control AMP ID code for the input area you want to use.

AMP ID code (remote control setting)	Function	Remote control AMP ID
2201 (initial setting)	To operate this unit using the default code.	ID1 (initial setting)
2202	To operate this unit using an alternative code.	ID2

5 Press **ENTER** to set the number.

"OK" appears in the display window if setting was successful.
"NG" appears in the display window if the setting was unsuccessful. In this case, start over from step 1.

6 Press **LEARN** again to exit from the setup mode.



ADVANCED OPERATION

English

■ Remote control TUNER ID REMOTE TU

Use this feature to set the TUNER ID of this unit for remote control recognition.

Choices: ID1, ID2

- Select "ID1" when the remote control TUNER ID code is set to "2602".
- Select "ID2" when the remote control TUNER ID code is set to "2610".

Setting remote control TUNER ID codes

You need to set the remote control TUNER ID library code for the remote control.

- 1 Set the operation mode selector to **AMP** or **SOURCE** and then press **TUNER** on the remote control to select the tuner to change the remote control ID.

- 2 Press and hold **LEARN** for about 3 seconds using a ballpoint pen or similar object and the **</>** repeatedly until "L;TUN" and "TUNER" appear in the display window on the remote control.

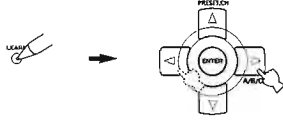

Notes

- Be sure to press and hold **LEARN** for at least 3 seconds, otherwise the learning process will start.
- If you do not complete each of the following steps within 30 seconds, the setting mode will be automatically canceled. In this case, start over from step 1.

- 3 Press **ENTER**.

The four-digit code set for the selected input area appears in the display window on the remote control.

- 4 Press the numeric buttons to enter the four-digit remote control code for the input area you want to use.

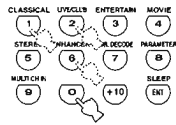

Remote control tuner ID codes

Select one of the following codes to set the remote control tuner ID code for the input area you want to use.

Tuner ID code (remote control setting)	Function	Remote control tuner ID (initial setting)
2602 (initial setting)	To operate this unit using the default code.	ID1 (initial setting)
2610	To operate this unit using an alternative code.	ID2

- 5 Press **ENTER** to set the number.

"OK" appears in the display window if setting was successful.
"NG" appears in the display window if the setting was unsuccessful. In this case, start over from step 1.

- 6 Press **LEARN** again to exit from the setup mode.



ADVANCED OPERATION

English

■ SIRIUS Satellite Radio Parental Lock personal identification number reset SR PIN

Use this feature to set the code number (personal identification number) for the SIRIUS Satellite Radio Parental Lock feature to the initial factory setting. This feature is useful when you forget or want to change the current code number.

Choices: RESET, CANCEL

- Select "RESET" to set the code number to the initial factory setting.
- Select "CANCEL" to set the code number to the initial factory setting.

Note

Even if you set "SR PIN" to "RESET", this unit does not unlock the locked channels. The initial factory setting of the Parental Lock code number is "0000".

■ Bi-amplifier setting BI-AMP

Use this feature to activate or deactivate the bi-amplifier function.

Choices: ON, OFF

- Select "ON" if you want to activate the bi-amplifier function. "SUR.B L/R SP" is set to "NONE" automatically, and this unit outputs the front channel audio signals at the SURROUND BACK/BI-AMP speaker terminals.
- Select "OFF" if you want to deactivate the bi-amplifier function.

Note

When "BI-AMP" is set to "ON", you can only select "FRONT B", "ZONE B", or "NONE" in "EXTRA SP ASSIGN".

■ SCENE IR code setting SCENE IR

Use this feature to output the remote control signals at the REMOTE OUT jack automatically when this unit is in the SCENE mode.

Choices: ON, OFF

- Select "ON" when the component connected to the REMOTE OUT jack is the Yamaha component and has the capability of the SCENE control signals. This unit automatically sends the remote control signals to the component.
- Select "OFF" when the component connected to the REMOTE OUT jack is not the Yamaha component and does not have the capability of the SCENE control signals.

Note

If noises are output when you operate the SCENE function, set "SCENE IR" to "OFF".

■ Monitor check MON.CHK

Use this feature to activate or deactivate the monitor check function of this unit. When "MON. CHK" is set to "YES", this unit receives the information of the available video signal resolutions from the video monitor connected via HDMI and you can only select the resolutions supported by the video monitor in "HDMI RES.". When "MON. CHK" is set to "SKIP", you can select any resolution in "HDMI RES.". Choices: YES, SKIP

■ Tuner frequency step TU (Asia and General models only)

Use this feature to set the tuner frequency step according to the frequency spacing in your area.

Choices: AM10/FM100, AM9/FM50

- Select "AM10/FM100" for North, Central and South America.
- Select "AM9/FM50" for all other areas.

■ Parameter initialization INIT

Use this feature to reset the parameters of this unit to the initial factory settings. You can select the category of parameters to be initialized.

Choices: DSP PARAM, VIDEO, ALL, CANCEL

- Select "DSP PARAM" to initialize all the parameters of the sound field programs.
- Select "VIDEO" to initialize the parameters in "VIDEO SET" and "OSD SHIFT" in "DISPLAY SET".
- Select "ALL" to initialize all the parameters of this unit.
- Select "CANCEL" to cancel the initialization procedure.

Note

Use "INITIALIZE" in the sound field program menu to initialize the parameters of the desired program.

Resetting the system

Use this feature to reset all the parameters of this unit to the initial factory settings.

Notes

- This procedure completely resets all the parameters of this unit including the "SET MENU" parameters.
- The initial factory settings are activated next time you turn on this unit.



To cancel the initialization procedure at any time without making any changes, press **SYSTEM OFF** on the front panel.

- 1 Press **SYSTEM OFF** on the front panel to set this unit to the standby mode.

- 2 Press and hold **TONE CONTROL** and then press **MAIN ZONE ON/OFF** to turn on this unit.

This unit turns on, and the advanced setup menu appears in the front panel display.

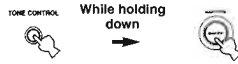

- 3 Rotate the **PROGRAM** selector to select "INIT".

- 4 Press **TONE CONTROL** repeatedly to select "ALL".



Select "CANCEL" to cancel the initialization procedure without making any changes.

- 5 Press **SYSTEM OFF** to confirm your selection and set this unit to the standby mode.

本機の設定を変更する (ADVANCED SETUP)

フロントパネルディスプレイに表示されるメニューを見ながら、さまざまな項目を設定します。アドバンスドセットアップメニューでは、本機の設定を初期設定に戻したり、リモコンIDを変更したりすることができます。お好みに合わせて、設定を変更してください。各項目の初期設定は、太字で記載しています。

ご注意

- 変更した設定は、STANDBY/ON キーを押して本機の電源を入れ直したときから有効になります。
- アドバンスドセットアップメニューの操作中は、本体の STANDBY/ON キー、TONE CONTROL キー、PROGRAM セレクター以外は機能しません。
- アドバンスドセットアップメニューの操作中は、他の操作はできません。
- アドバンスドセットアップメニューはフロントパネルディスプレイでのみ操作できます。

アドバンスドセットアップメニューの操作手順

1 本体の STANDBY/ON キーを押して、本機の電源をスタンバイにする。

2 TONE CONTROL キーを押しながら、もう一度 STANDBY/ON キーを押す。
本機の電源がオンになり、アドバンスドセットアップメニューがフロントパネルディスプレイに表示されます。

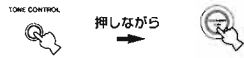

3 PROGRAM セレクターを回して、設定したいメニューを選ぶ。
フロントパネルディスプレイにメニューが表示されます。

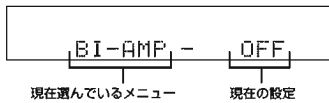

4 TONE CONTROL キーを繰り返し押して、設定したい項目を選ぶ。

5 STANDBY/ON キーを押して、本機の電源をスタンバイにする。
変更した設定が保存されます。

※
変更した設定は、次回電源を入れたときから有効になります。

■ アンブレ用リモコン ID 設定 REMOTE AMP
本体のアンブレ用リモコン ID を、リモコンのアンブレ用コードの設定に合わせて切り替えます。本機を設置している部屋で別のヤマハ製アンブレをお使いの場合、本機のリモコン操作でもう1台のアンブレが動作するのを防止します。

選択項目: ID1、ID2

- リモコンのアンブレ用コードを「00001」に設定しているときは、「ID1」を選んでください。
- リモコンのアンブレ用コードを「00002」に設定しているときは、「ID2」を選んでください。

リモコンのアンブレ用コードを変更する
リモコンのアンブレ用コードをアンブレ用リモコン ID に合わせて変更します。

1 CODE SET ボタンを、ボールペンなどの先の細いもので押す。
TRANSMIT インジケータが2回点滅します。



2 数字キーを押して、「00001」または「00002」と入力する。
TRANSMIT インジケータが2回点滅し、アンブレ用コードが変更されます。

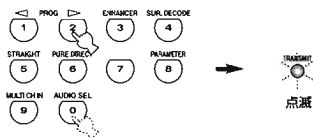

応用操作

本機の設定を変更する (ADVANCED SETUP)

アンブレ ID コード*1	機能	アンブレ用リモコン ID *2
00001 (初期設定)	初期設定のコードを使って操作します。	ID1 (初期設定)
00002	別コードを使って操作します。	ID2

*1 リモコン側の設定
*2 本体側の設定

■ チューナー用リモコン ID 設定 REMOTE TU
本体のチューナー用リモコン ID を、リモコンのチューナー用コードの設定に合わせて切り替えます。

選択項目: ID1、ID2

- リモコンのチューナー用コードを「82915」に設定しているときは、「ID1」を選んでください。
- リモコンのチューナー用コードを「82178」に設定しているときは、「ID2」を選んでください。

リモコンのチューナー用コードを変更する
リモコンのチューナー用コードをチューナー用 ID に合わせて変更します。

1 TUNER キーを押して、入力をチューナーに切り替える。



2 CODE SET ボタンを、ボールペンなどの先の細いもので押す。
TRANSMIT インジケータが2回点滅します。



3 数字キーを押して、「82915」または「82178」と入力する。
TRANSMIT インジケータが2回点滅し、チューナー用コードが変更されます。

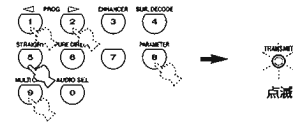

チューナー ID コード*1	機能	チューナー用リモコン ID *2
82915 (初期設定)	初期設定のコードを使って操作します。	ID1 (初期設定)
82178	別コードを使って操作します。	ID2

*1 リモコン側の設定
*2 本体側の設定

■ バイアンブレ設定 BI-AMP
SURROUND BACK/BI-AMP 端子を使って、バイアンブレ接続するかしないかを設定します。

選択項目: ON、OFF

- バイアンブレ接続する場合は、「ON」を選んでください。「SUR. B L/R SP」が自動的に「NONE」に設定され、本機の SURROUND BACK/BI-AMP 端子からはフロントチャンネル信号が出力されます。
- バイアンブレ接続しない場合は、「OFF」を選んでください。

ご注意

「BI-AMP」を「ON」に設定した場合、「EXTRA SP ASSIGN」の「PRESENCE」は選べません。

■ SCENE 選択時の IR 出力設定 SCENE IR
SCENE (シーン) キーを押したときに、本機リアパネルの REMOTE OUT 端子からコントロール信号を出力するかしないかを設定します。

選択項目: ON、OFF

- 本機の REMOTE OUT 端子に接続した機器が SCENE コントロール信号の受信機能を持つヤマハ製機器の場合は、「ON」を選んでください。本機は自動的に、接続した機器にコントロール信号を送ります。
- 本機の REMOTE OUT 端子に接続した機器がヤマハ製機器でない場合や、SCENE コントロール信号の受信機能を持たない場合は、「OFF」を選んでください。

ご注意

SCENE 機能を操作しているときにノイズが出力される場合は、「OFF」に設定してください。

■ 解像度変換時の選択肢設定 MON. CHK [VIDEO SET] の「HDMI RES」で、本機と HDMI 接続したモニターが対応していない解像度を選ぶようにするか、選ばないようにするかを設定します。「YES」に設定すると、モニターが対応していない解像度は選べなくなります。選択項目: YES、SKIP

本機の設定を変更する (ADVANCED SETUP)

■ 初期設定に戻す INIT

変更した設定を初期設定に戻します。初期設定に戻す項目を選んでください。

選択項目: DSP PARAM、VIDEO、ALL、CANCEL

- 音場プログラムを初期設定に戻すには、「DSP PARAM」を選んでください。
- 「DISPLAY SET」の「VIDEO SET」、および「OSD SHIFT」を初期設定に戻すには、「VIDEO」を選んでください。
- すべてを初期設定に戻すには、「ALL」を選んでください。
- 初期設定に戻さない場合は、「CANCEL」を選んでください。

ご注意

音場プログラムごとに音場パラメータを初期設定に戻すには、音場パラメータ「INITIALIZE」で設定してください。

応用操作

すべての設定を初期設定に戻す

変更したセットメニューの設定や音場パラメータ、プリセットした FM / AM 放送局などをすべて初期設定に戻します。

ご注意

変更した設定は、次回電源を入れたときから有効になります。

※

初期化操作を中止するには、フロントパネルの STANDBY/ON キーを押してください。

1 STANDBY/ON キーを押して、本機の電源をスタンバイにする。

2 TONE CONTROL キーを押しながら STANDBY/ON キーを押す。

本機の電源がオンになり、フロントパネルディスプレイにアドバンスドセットアップメニューが表示されます。

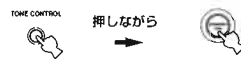

3 PROGRAM セレクターを回して、「INIT」を選ぶ。

4 TONE CONTROL キーを繰り返し押して、「ALL」を選ぶ。

※
初期設定に戻さない場合は、「CANCEL」を選んでください。

5 STANDBY/ON キーを押して、本機の電源をスタンバイにする。
すべての設定が初期設定に戻ります。

Using Bluetooth™ components

You can connect a Yamaha Bluetooth adapter (such as YBA-10, sold separately) to the DOCK terminal of this unit and enjoy the music contents stored in your Bluetooth component (such as a portable music player) without wiring between this unit and the Bluetooth component. You need to perform “pairing” the connected Bluetooth adapter and your Bluetooth component in advance.

Pairing the Bluetooth™ adapter and your Bluetooth component

Pairing must be performed when using a Bluetooth component with the Bluetooth adapter connected to this unit for the first time or if the pairing data has been deleted. “Pairing” refers to the operation of registering a Bluetooth component for Bluetooth communications.

- ※ You only need the pairing operation for the first time that you use the Bluetooth component with the Bluetooth adapter.
- Pairing requires operations on this unit and on the other component with which Bluetooth communications are to be established. If necessary, refer to the other component’s operating instructions.

There are two pairing methods: pairing by using “START PAIRING” in “SET MENU” and quick pairing.

■ Pairing by using “SET MENU”

Use this feature to perform pairing with the video monitor. Select “START PAIRING” in “INPUT MENU”.

■ Quick pairing

To ensure security, a time limit of 8 minutes is set for the pairing operation. You are recommended to read and fully understand all the instructions before starting.

- 1 Rotate the **Ⓔ INPUT** selector (or set the operation mode selector to **Ⓔ SOURCE** and then press **④ V-AUX**) to select “V-AUX” as the input source.

- 2 Turn on the Bluetooth component you want to pair with.

- 3 Press and hold **Ⓒ BAND** (or **Ⓙ BAND**) for 3 seconds to start pairing.

Once the Bluetooth adapter starts pairing, “Searching...” appears for a moment. While the Bluetooth adapter is in the pairing mode, DOCK indicator flashes in the front panel display.

- ※ To cancel the pairing, press **Ⓒ BAND** (or **Ⓙ BAND**) again.

Note

If the Bluetooth adapter is not connected to the DOCK terminal of this unit, “No BT adapter” appears in the front panel display.

- 4 Check that the Bluetooth component detects the Bluetooth adapter.

If the Bluetooth component detects the Bluetooth adapter, “YBA-10 YAMAHA” (example) appears in the Bluetooth device list.

- 5 Select the Bluetooth adapter in the Bluetooth device list and then enter the pass key “0000” on the Bluetooth component.

When the pairing procedure is successful, “Completed” appears in the front panel display.

Note

The Yamaha Bluetooth adapter can be paired with up to eight Bluetooth components. When pairing is conducted successfully with a ninth component and the pairing data is registered, the pairing data for the least recently used other component is cleared.

Playback of the Bluetooth™ component

- 1 Rotate the **Ⓔ INPUT** selector (or set the operation mode selector to **Ⓔ SOURCE** and then press **④ V-AUX**) to select “V-AUX” as the input source.

- 2 Start playback of your Bluetooth component.

When the connected Bluetooth adapter detects the Bluetooth component, “BT connected” and the DOCK indicator appears in the front panel display.

※

- When you press **Ⓒ ENTER** on the remote control, the connected Bluetooth adapter searches and connect to the last connected Bluetooth component. If the Bluetooth adapter cannot find the Bluetooth component, “Not found” appears in the front panel display.
- To disconnect the Bluetooth adapter from the Bluetooth component, press **Ⓒ RETURN**.

Bluetooth® 機器を再生する

ヤマハ製 Bluetooth アダプター (別売 YBA-10 など) を DOCK 端子に接続すれば、本機と Bluetooth 機器 (ポータブルオーディオプレーヤーなど) をケーブルで接続することなく、Bluetooth 機器に保存した音楽ファイルを再生できます。再生する前に、Bluetooth アダプターと Bluetooth 機器を「ペアリング」してください。

ご注意

Bluetooth アダプターが DOCK 端子に接続されていない場合は、フロントパネルディスプレイに「No BT Adapter」と表示されます。

- 4 Bluetooth 機器が Bluetooth アダプターを認識していることを確認する。

Bluetooth 機器が Bluetooth アダプターを認識している場合は、Bluetooth デバイスリストに「YBA-10 YAMAHA」(例) と表示されます。

- 5 Bluetooth デバイスリストから Bluetooth アダプターを選び、Bluetooth 機器にパスキー「0000」を入力する。

正しくペアリングされた場合は、フロントパネルディスプレイに「Completed」と表示されます。

ご注意

ヤマハ製 Bluetooth アダプターは 8 台までの Bluetooth 機器とペアリングできます。9 台目の機器が正しくペアリングされ、ペアリングデータが登録された場合、最初にペアリングした機器のデータは消去されます。

Bluetooth® 機器の再生を楽しむ

- 1 **Ⓔ INPUT** セレクターを回して (または操作機器選択スイッチ **Ⓔ**) で **SOURCE** を選び、**④ V-AUX** キーを押して、**V-AUX** を入力選択する。

- 2 Bluetooth 機器の再生を開始する。
接続した Bluetooth アダプターが Bluetooth 機器を認識すると、フロントパネルディスプレイに「BT connected」と表示され、DOCK インジケーターが点灯します。

※

- Ⓒ ENTER** キーを押すと、接続した Bluetooth アダプターは最後に接続していた Bluetooth 機器を検索し、接続します。Bluetooth アダプターが Bluetooth 機器を検索できなかった場合は、フロントパネルディスプレイに「Not found」と表示されます。
Bluetooth アダプターと Bluetooth 機器の接続を解除するには、**Ⓒ RETURN** キーを押してください。

Bluetooth® アダプターと Bluetooth® 機器をペアリングする

Bluetooth 機器を Bluetooth アダプターを使って本機で再生する前に、「ペアリング」を行います。本機側をはじめて使う場合や、ペアリングしたデータが消去された場合は、必ず行ってください。「ペアリング」とは、Bluetooth で通信するために Bluetooth 機器を登録することです。

※

- ペアリングは、Bluetooth 機器と Bluetooth アダプターをはじめて使うときのみ必要です。
Bluetooth で通信できるようにするには、本機および Bluetooth 機器の両方でペアリングしてください。必要に応じて Bluetooth 機器の取扱説明書もご覧ください。

本機では、セットメニュー「START PAIRING」と、クイックペアリングの 2 種類の方法でペアリングできます。

■ セットメニューでペアリングする

モニターに表示されるメニューを見ながらペアリングします。「INPUT MENU」の「START PAIRING」を選んでください。

■ クイックペアリングでペアリングする

セキュリティ確保のため、ペアリングできる時間は 8 分に制限されています。以下の手順を一通り読んでから操作に移ることをおすすめます。

- 1 **Ⓔ INPUT** セレクターを回して (または操作機器選択スイッチ **Ⓔ**) で **SOURCE** を選び、**④ V-AUX** キーを押して、**V-AUX** を入力選択する。

- 2 ペアリングしたい Bluetooth 機器の電源をオンにする。

- 3 **Ⓒ BAND** キー (または **Ⓙ BAND** キー) を、約 3 秒間押し続ける。

フロントパネルディスプレイに「Searching...」と一時的に表示され、DOCK インジケーターが点滅します。

※

ペアリングをキャンセルするには、再度 **Ⓒ BAND** キー (または **Ⓙ BAND** キー) を押します。

基本操作

**RX-V863/HTR-6180/
DSP-AX863SE/DSP-AX863**

